



Catalog  
D 31.1

















Edition  
May  
2023

MOTION CONTROL DRIVES

# SINAMICS Converters for Single-Axis Drives Built-In Units

[siemens.com/d31-1](https://www.siemens.com/d31-1)

## Related catalogs

<p><b>Motion Control Drives</b> D 31.2 SINAMICS Converters for Single-Axis Drives Distributed Converters</p> <p>PDF (E86060-K5531-A121-A2-7600)</p>		<p><b>Motion Control System</b> PM 21 SIMOTION Equipment for Production Machines</p> <p>E86060-K4921-A101-A4-7600</p>	
<p><b>Motion Control Drives</b> D 31.5 SINAMICS Converters for Single-Axis Drives SINAMICS G120X infrastructure converters for HVAC/Water/Wastewater</p> <p>PDF (E86060-K5531-A151-A4-7600)</p>		<p><b>Industrial Controls</b> IC 10 SIRIUS</p> <p>PDF (E86060-K1010-A101-B5-7600)</p>	
<p><b>Motion Control Drives</b> D 32 SINAMICS S210 Servo Drive System</p> <p>PDF (E86060-K5532-A101-A8-7600)</p>		<p><b>Low-Voltage Power Distribution and Electrical Installation Technology</b> LV 10 SENTRON • SIVACON • ALPHA</p> <p>PDF (E86060-K8280-A101-B6-7600)</p>	
<p><b>Motion Control Drives</b> D 34 SIMATIC MICRO-DRIVE Servo Drive System</p> <p>PDF (E86060-K5534-A101-A2-7600)</p>		<p><b>SIMATIC</b> ST 70 Products for Totally Integrated Automation</p> <p>PDF (E86060-K4670-A101-B9-7600)</p>	
<p><b>SINAMICS S120</b> D 21.3 Chassis Format Converter Units Chassis-2 Format Converter Units Cabinet Modules, Cabinet Modules-2 <b>SINAMICS S150</b> Converter Cabinet Units PDF (E86060-K5521-A131-A8-7600)</p>		<p><b>SIMATIC HMI / PC-based Automation</b> ST 80/ST PC Human Machine Interface Systems PC-based Automation</p> <p>PDF (E86060-K4680-A101-D0-7600)</p>	
<p><b>Motion Control Drives</b> D 21.4 SINAMICS S120 and SIMOTICS</p> <p>E86060-K5521-A141-A1-7600</p>		<p><b>Industrial Communication</b> IK PI SIMATIC NET</p> <p>E86060-K6710-A101-B8-7600</p>	
<p><b>SIMOTICS S-1FG1</b> D 41 <b>Servo geared motors</b> Helical, Parallel shaft, Bevel and Helical worm geared motors</p> <p>PDF (E86060-K5541-A101-A6-7600)</p>		<p><b>SITRAIN</b> Digital Industry Academy</p> <p><a href="http://www.siemens.com/sitrain">www.siemens.com/sitrain</a></p>	
<p><b>SIMOTICS GP, SD, XP, DP</b> D 81.1 <b>Low-Voltage Motors</b> Type series 1FP1, 1LE1, 1LE5, 1MB1, 1MB5, 1PC1 Frame sizes 63 to 450 Power range 0.09 to 1000 kW PDF (E86060-K5581-A111-B6-7600)</p>		<p><b>SiePortal</b> Information and Ordering Platform on the Internet:</p> <p><a href="http://sieportal.siemens.com">sieportal.siemens.com</a></p>	
<p><b>SIMOGEAR</b> D 50.1 <b>Geared Motors</b> Helical, parallel shaft, bevel, helical worm, worm geared motors and electric-monorail geared motors PDF (E86060-K5250-A111-A9-7600)</p>			

Catalog  
D 31.1

Edition  
May  
2023

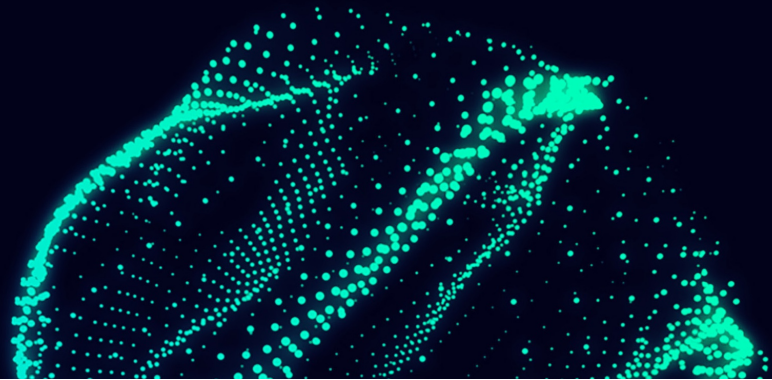

## MOTION CONTROL DRIVES

# SINAMICS Converters for Single-Axis Drives Built-In Units

[siemens.com/d31-1](https://www.siemens.com/d31-1)

Dear customer,

We are pleased to present you the new edition of the Catalog D 31.1 · May 2023.

The catalog provides a comprehensive overview of SINAMICS converters for single-axis drives – **built-in units** – comprising the product families SINAMICS V20, SINAMICS G120C, SINAMICS G120 and SINAMICS S110.

The catalog has been revised and supplemented.

The products listed in this catalog are also included in SiePortal. Please contact your local Siemens office for additional information.

Up-to-date information about SINAMICS is available on the internet at  
[www.siemens.com/sinamics](https://www.siemens.com/sinamics)

You can access SiePortal on the internet at  
<https://sieportal.siemens.com>

Your personal contact will be glad to receive your suggestions and recommendations for improvement.

You can find your representative in our Personal Contact database at:  
[www.siemens.com/automation-contact](https://www.siemens.com/automation-contact)

We hope that you will often enjoy using Catalog D 31.1 · May 2023 as a selection and ordering reference document and wish you every success with our products and solutions.

With kind regards,

Frank Golüke  
Vice President  
General Motion Control  
Siemens AG, Digital Industries, Motion Control



# SINAMICS Converters for Single-Axis Drives

## Built-In Units

### Motion Control Drives



### Catalog D 31.1 · May 2023

Supersedes:  
Catalog D 31.1 · October 2021

Refer to SiePortal for current updates of this catalog:  
[sieportal.siemens.com](http://sieportal.siemens.com)

Please contact your local Siemens branch.

© Siemens 2023

Click on an Article No. in the catalog PDF to call it up in SiePortal and to obtain all the information.

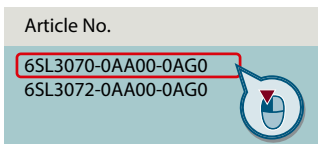

Or directly on the internet, e.g.  
[www.siemens.com/product?6SL3070-0AA00-0AG0](http://www.siemens.com/product?6SL3070-0AA00-0AG0)



The products and systems described in this catalog are manufactured/distributed under application of a certified quality management system in accordance with EN ISO 9001. The certificate is recognized by all IQNet countries.

System overview	1
Firmware functionality	2
Safety Integrated	3
Energy efficiency	4
Communication	5
Technology functions	6
<b>SINAMICS V20 basic converters</b>	<b>7</b>
<b>SINAMICS G120C compact converters</b>	<b>8</b>
<b>SINAMICS G120 standard converters</b>	<b>9</b>
<b>SINAMICS S110 servo drives</b>	<b>10</b>
<b>SIMOTICS motors and SIMOGEAR geared motors</b>	<b>11</b>
Engineering tools	12
Drive applications	13
Services and documentation	14
Appendix	15

# Digitalization in drive technology

## From the digital world to the real world

[siemens.com/digital-drives](https://www.siemens.com/digital-drives)

### *Increase your transparency and productivity by digitalizing your drive technology*

Many drives are used in the manufacturing and process industries. They produce lots of data anyway – why not use them to increase the availability and productivity of machines and plants?

Drive technology offers the ideal entry point into the world of digitalization – for plant and machine builders as well as for users.

The digitalization portfolio for the drive train spans over the complete life cycle – from the design phase to realization and optimization – in the digital and the real world.

Our portfolio contains drive simulation solutions and efficient engineering tools, comprehensive connectivity that allows drives to be easily linked to the relevant platforms as well as smart analytics (e.g. cloud and edge apps) and drive system services.

These solutions enable you to gain a better understanding of processes, states and utilization. The health status of the drive train can be monitored and analyzing drive data enables an early detection of anomalies and reduces downtimes. This way, availability and productivity of machines and plants can be increased and the actual maintenance demand can be identified. Furthermore, data-based business models and service offerings are facilitated.

### *Our digitalization portfolio covers all phases of the life cycle: from the design phase to realization and optimization. It covers the digital and the real drive train.*

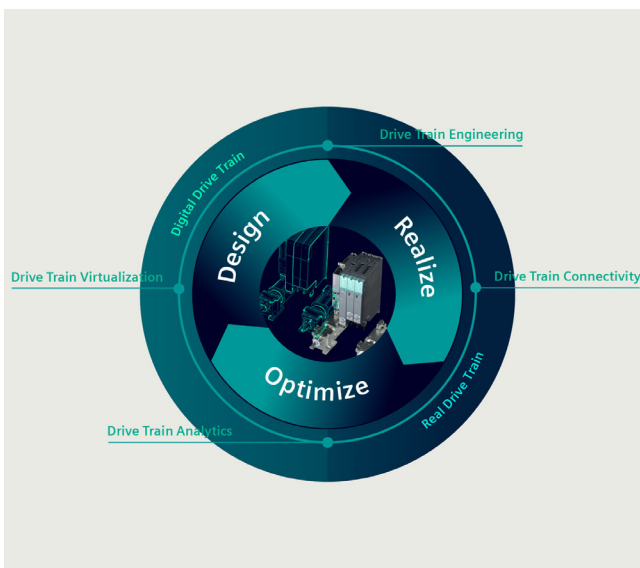

**Design:** By creating a digital twin of the drives, machine builders can shorten their time-to-market since they can design, simulate and optimize their machine before ordering any material or products. Together with other tools from the engineering box, simulation can also speed up the engineering phase of drives and entire machines, for example by virtual commissioning of the PLC.

**Realize:** Once the machine is in operation, the drives can be connected to other platforms, for example to the cloud and Industrial Edge. This creates transparency in terms of what is going on inside the drive train, e.g. with regard to the actual current, torque and speed.

**Optimize:** To understand the collected data, our drive train analytics portfolio provides algorithms and analysis tools to unlock the potential of the data and turn the gained transparency into insights and valuable knowledge. These insights can then again be used in the design phase of the next life cycle, thus closing the loop.

## Benefits of drive train digitalization

### Machine builders



#### Availability



Increase the availability of your machines

#### Speed



Shorten time-to-market

#### Business models



Develop new service and business models

### Machine operators



#### Productivity



Increase the productivity of your production

#### Flexibility



Increase the flexibility of your production

#### Efficiency



Identify potential for optimization

### Benefits for machine and plant builders

- Increased availability of machines and plants – thanks to digital options for checking and implementing design improvements and comprehensive monitoring of drive systems
- Shorter time-to-market and faster development times – thanks to practical software tools and a continuous database for concurrent development processes as well as virtual simulations, tests, and commissioning of machines and plants
- New options for future service and business models – ranging from customized application solutions and digital services to contractually guaranteed availabilities of machines and plants

### Benefits for machine and plant operators

- Increased availability and productivity of production, fewer unscheduled downtimes – through the early detection of deviations and emerging risks thanks to digital drive monitoring
- More flexible production down to batch size 1 – through more effective use of knowledge from existing production lines thanks to transparent utilization, states, locations, and capacities down to the drive level
- Identification of potential for optimization to make production faster, better, and more efficient thanks to data-based transparency – for example, for faster modifications, simpler quality control, and the early prediction of maintenance demand as well as demand-oriented maintenance



# TIA Selection Tool – quick, easy, smart configuration

For you to get the most out of our portfolio quickly and easily.

Do you always need the optimum configuration for planning your project?

For your application we offer the TIA Selection Tool to support all project planners, beginners and experts alike.

No detailed portfolio knowledge is necessary.

TIA Selection Tool is available for download as a free desktop version or a cloud variant.

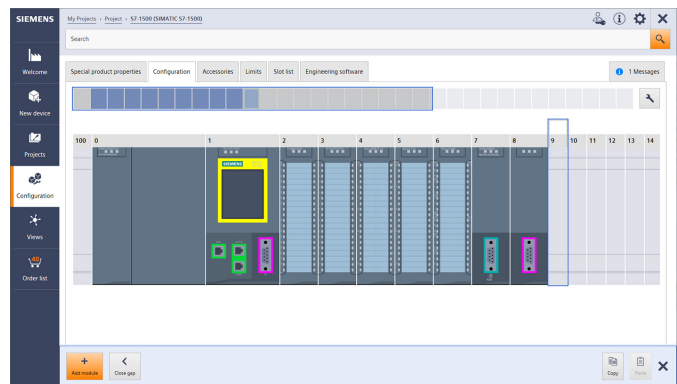

## Your Advantages

### Quick

- Configure a complete project with just a few entries – without a manual, without special knowledge
- Import and export of hardware configuration to TIA Portal or other systems
- Ideal visualization of the projects to be configured

### Easy

- Tool download either as desktop version or web-based cloud version
- Technically always up-to-date about product portfolio and innovative approaches
- Highly flexible, secure, cross-team work in the cloud
- Direct ordering in the Siemens Industry Mall

### Smart

- Smart selection wizard for error-free configuration and ordering
- Configuration options can be tested and simulated in advance
- Library for archiving sample configurations

The TIA Selection Tool is a completely paperless solution.

Download it now:

[www.siemens.com/tst](http://www.siemens.com/tst)

For more  
information,  
scan the  
QR code





## System overview



1/2	<b>The SINAMICS converter family</b>
1/6	<b>Drive selection</b>
1/7	<b>SIMOTICS motors</b>
1/7	<b>SIMOGEAR geared motors</b>
1/8	<b>SIMOTICS low-voltage motors for line and converter operation</b>
1/9	<b>Motion Control Encoder measuring systems</b>
1/10	<b>MOTION-CONNECT connection systems</b>

Further information about SINAMICS, SIMOTICS and SIMOGEAR can be found on the internet at  
[www.siemens.com/sinamics](http://www.siemens.com/sinamics)  
[www.siemens.com/simotics](http://www.siemens.com/simotics)  
[www.siemens.com/simogear](http://www.siemens.com/simogear)

# System overview

## The SINAMICS converter family

### Overview

#### Integration in automation

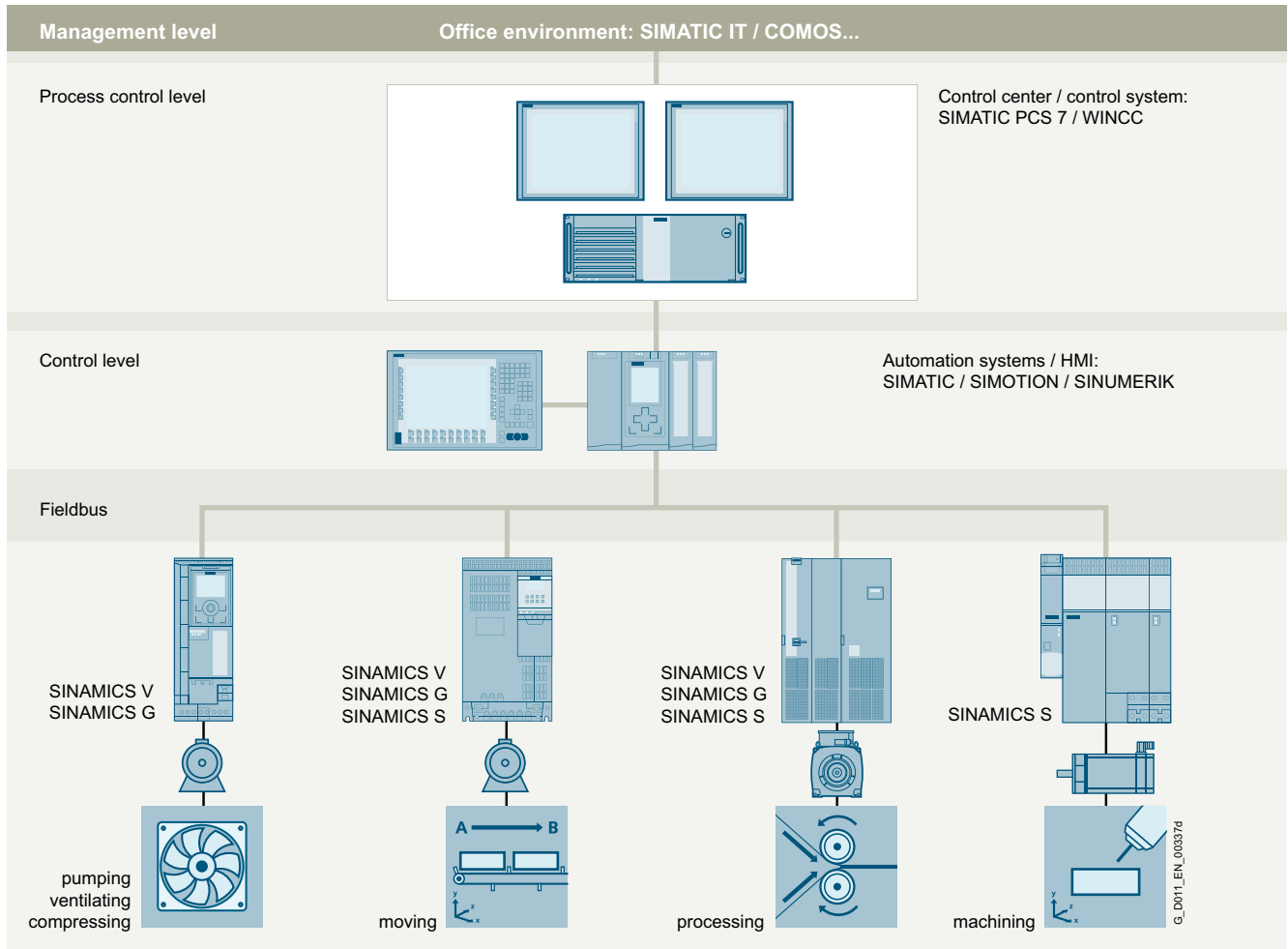

#### Totally Integrated Automation and communication

SINAMICS is an integral component of the Siemens "Totally Integrated Automation" concept. Integrated SINAMICS systems covering configuration, data storage, and communication at automation level ensure low-maintenance solutions with the SIMATIC, SIMOTION and SINUMERIK control systems.

Depending on the application, the appropriate variable frequency drives can be selected and incorporated in the automation concept. With this in mind, the drives are clearly subdivided into their different applications. A wide range of communication options (depending on the drive type) are available for establishing a communication link to the automation system:

- PROFINET
- PROFIBUS
- EtherNet/IP
- Modbus TCP
- Modbus RTU
- AS-Interface
- BACnet MS/TP

#### Applications

SINAMICS is the comprehensive converter family from Siemens designed for machine and plant engineering applications. SINAMICS offers solutions for all drive tasks:

- Simple pump and fan applications in the process industry
- Demanding single drives in centrifuges, presses, extruders, elevators, as well as conveyor and transport systems
- Drive line-ups in textile, plastic film, and paper machines as well as in rolling mill plants
- Highly dynamic servo drives for machine tools, as well as packaging and printing machines

## Overview

**SINAMICS as part of the Siemens modular automation system****Innovative, energy-efficient and reliable drive systems and applications as well as services for the entire drive train**

The solutions for drive technology place great emphasis on the highest productivity, energy efficiency and reliability for all torque ranges, performance and voltage classes.

Siemens offers not only the right innovative variable frequency drive for every drive application, but also a wide range of energy-efficient low-voltage motors, geared motors, explosion-protected motors and high-voltage motors for combination with SINAMICS.

Furthermore, Siemens supports its customers with global pre-sales and after-sales services, with over 295 service points in 130 countries – and with special services e.g. application consulting or motion control solutions.

**Energy efficiency**Energy management process

Efficient energy management consultancy identifies the energy flows, determines the potential for making savings and implements them with focused activities.

Almost two thirds of the industrial power requirement is from electric motors. This makes it all the more important to use drive technology permitting energy consumption to be reduced effectively even in the configuration phase, and consequently to optimize plant availability and process stability. With SINAMICS, Siemens offers powerful energy efficient solutions which, depending on the application, enable a significant reduction in electricity costs.

# System overview

1

## The SINAMICS converter family

### Overview

#### Up to 70 % potential for savings using variable-speed operation

SINAMICS enables great potential for savings to be realized by controlling the motor speed. In particular, huge potential savings can be recovered from pumps, fans and compressors which are operated with mechanical throttle and valves. Here, changing to variable-speed drives brings enormous economic advantages. In contrast to mechanical control systems, the power consumption at partial load operation is always immediately adjusted to the demand at that time. So energy is no longer wasted, permitting savings of up to 60 % – in exceptional cases even up to 70 %. Variable-speed drives also offer clear advantages over mechanical control systems when it comes to maintenance and repair. Current spikes when starting up the motor and strong torque surges become things of the past – and the same goes for pressure waves in pipelines, cavitation or vibrations which cause sustainable damage to the plant. Smooth starting and ramp-down relieve the load on the mechanical system, ensuring a significantly longer service life of the entire drive train.

#### **Variants**

Depending on the application, the SINAMICS converter family offers the ideal variant for any drive task.

#### Regenerative feedback of braking energy

In conventional drive systems, the energy produced during braking is converted to heat using braking resistors. Energy produced during braking is efficiently recovered to the supply system by versions of SINAMICS G and SINAMICS S drives with regenerative feedback capability and these devices do not therefore need a braking resistor. This permits up to 60 % of the energy requirement to be saved, e.g. in lifting applications. Energy which can be reused at other locations on a machine. Furthermore, this reduced power loss simplifies the cooling of the system, enabling a more compact design.

#### SINAMICS in combination with energy-saving motors

Engineering integration stretches beyond the SINAMICS converter family to higher-level automation systems, and to a broad spectrum of energy-efficient motors with a wide range of performance classes, which, compared to previous motors, are able to demonstrate up to 10 % greater efficiency.

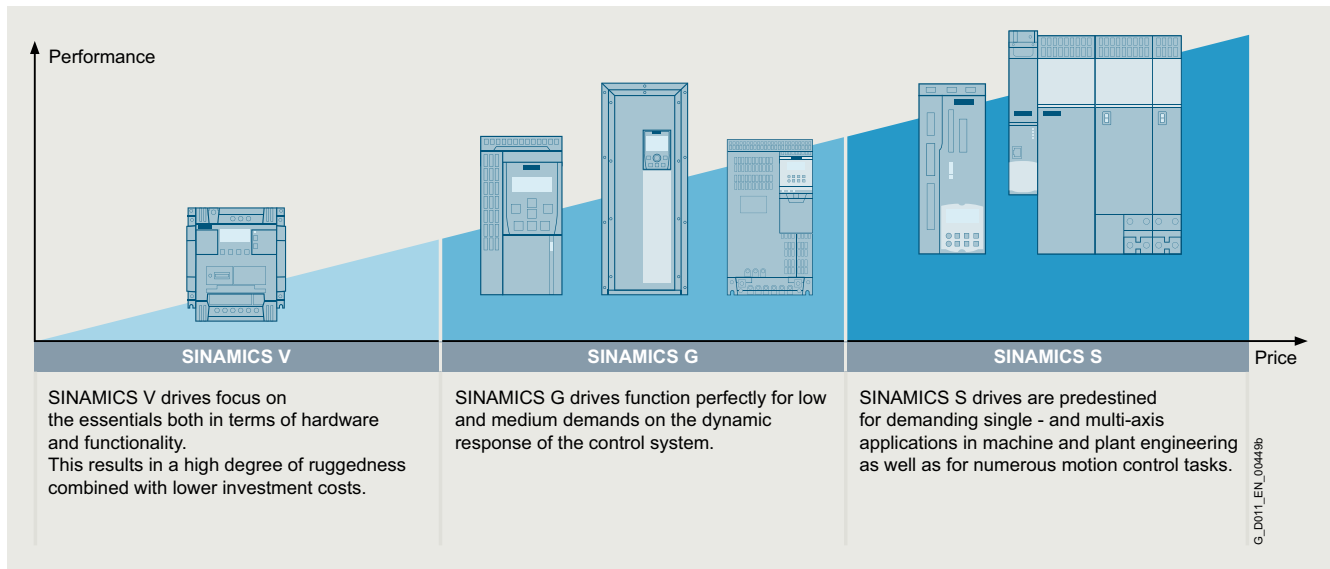

Overview

Platform concept

All SINAMICS variants are based on a platform concept. Joint hardware and software components, as well as standardized tools for dimensioning, configuration, and commissioning tasks ensure high-level integration across all components. SINAMICS handles a wide variety of drive tasks with no system gaps. The different SINAMICS variants can be easily combined with each other.

Quality management according to EN ISO 9001

SINAMICS conforms to the most exacting quality requirements. Comprehensive quality assurance measures in all development and production processes ensure a consistently high level of quality.

Of course, our quality management system is certified by an independent authority in accordance with EN ISO 9001.

Integrated system configuration

Siemens offers perfectly matched drive components with which you can meet your requirements. The drive components reveal their true strengths over the full range from engineering and commissioning through to operation: Integrated system configuration is performed using the Siemens Product Configurator: Just select a motor and a converter and design them with the SIZER for Siemens Drives (integrated in TIA Selection Tool) engineering tool. The STARTER and SINAMICS Startdrive commissioning tools integrate the motor data and at the same time simplify efficient commissioning. All drive components are incorporated in the TIA Portal – this simplifies engineering, commissioning and diagnostics.

Low voltage										Direct voltage	Medium voltage
Standard performance frequency converters		Distributed frequency converters	Industry-specific frequency converters		Servo converters			High performance frequency converters		DC converters	Converters for applications with high outputs
SINAMICS V20 G120C G120	SINAMICS G130 G150	SINAMICS G115D G120D SIMATIC ET 200pro FC-2	SINAMICS G120X	SINAMICS G180	SINAMICS V90	SINAMICS S110	SINAMICS S210	SINAMICS S120 S120M	SINAMICS S150	SINAMICS DCM DCP <sup>1)</sup>	SINAMICS GH150 GH180 GM150 SM150 GL150 SL150 SH150
0.12 kW to 250 kW	75 kW to 2700 kW	0.37 kW to 7.5 kW	0.75 kW to 630 kW	2.2 kW to 6600 kW	0.05 kW to 7 kW	0.55 kW to 132 kW	0.05 kW to 7 kW	0.55 kW to 5700 kW	75 kW to 1200 kW	6 kW to 30 MW	0.15 MW to 85 MW
Pumps, fans, compressors, conveyor belts, mixers, mills, spinning machines, textile machines, refrigerated display counters, fitness equipment, ventilation systems, single-axis positioning applications in machine and plant engineering	Pumps, fans, compressors, conveyor belts, mixers, mills, extruders	Conveyor technology, single-axis positioning applications (G120D)	Pumps, fans, compressors, building management systems, process industry, HVAC, water/waste water industries	Pumps, fans, compressors, conveyor belts, extruders, mixers, mills, kneaders, centrifuges, separators	Handling machines, packaging machines, automatic assembly machines, metal forming machines, printing machines, winding and unwinding units	Single-axis positioning applications in machine and plant engineering	Packaging machines, handling equipment, feed and withdrawal devices, stacking units, automatic assembly machines, laboratory automation, wood, glass and ceramics industry, digital printing machines	Production machines (packaging, textile and printing machines, paper machines, plastic processing machines), machine tools, plants, process lines and rolling mills, marine drives, test bays	Test bays, cross cutters, centrifuges	Rolling mill drives, wire-drawing machines, extruders and kneaders, cableways and lifts, test bay drives	Pumps, fans, compressors, mixers, extruders, mills, crushers, rolling mills, conveyor technology, excavators, test bays, marine drives, blast furnace fans, retrofit
Catalog D 31.1	Catalog D 11	Catalog D 31.2	Catalog D 31.5	Catalog D 18.1	Catalog D 33	Catalog D 31.1	Catalog D 32	Catalogs D 21.3, D 21.4 NC 62	Catalog D 21.3	Catalog D 23.1, Industry Mall	Internet <sup>2)</sup>

Engineering tools (e.g. Siemens Product Configurator, SIZER for Siemens Drives, STARTER and SINAMICS Startdrive)

<sup>1)</sup> DC/DC controllers, see Industry Mall.

<sup>2)</sup> [www.siemens.com/medium-voltage-converter](http://www.siemens.com/medium-voltage-converter)

# System overview

## Drive selection

1

### Overview

#### SINAMICS selection guide – typical applications

Use	Requirements for torque accuracy/speed accuracy/position accuracy/coordination of axes/functionality					
	Continuous motion			Non-continuous motion		
	Basic	Medium	High	Basic	Medium	High
<b>Pumping, ventilating, compressing</b>	Centrifugal pumps Radial / axial fans Compressors	Centrifugal pumps Radial / axial fans Compressors	Eccentric screw pumps	Hydraulic pumps Metering pumps	Hydraulic pumps Metering pumps	Descaling pumps Hydraulic pumps
	V20 G120C G120X	G120X G130/G150 G180 <sup>1)</sup> DCM	S120	G120	S110	S120
<b>Moving</b>	Conveyor belts Roller conveyors Chain conveyors	Conveyor belts Roller conveyors Chain conveyors Lifting/ lowering devices Elevators Escalators/ moving walkways Indoor cranes Marine drives Cable railways	Elevators Container cranes Mining hoists Excavators for open-cast mining Test bays	Acceleration conveyors Storage and retrieval machines	Acceleration conveyors Storage and retrieval machines Cross cutters Reel changers	Storage and retrieval machines Robotics Pick & place Rotary indexing tables Cross cutters Roll feeds Engagers/ disengagers
	V20 G115D G120C ET 200pro FC-2 <sup>2)</sup>	G120 G120D G130/G150 G180 <sup>1)</sup>	S120 S150 DCM	V90 G120 G120D	S110 S210 DCM	S120 S210 DCM
<b>Processing</b>	Mills Mixers Kneaders Crushers Agitators Centrifuges	Mills Mixers Kneaders Crushers Agitators Centrifuges Extruders Rotary furnaces	Extruders Winders/unwinders Lead/follower drives Calenders Main press drives Printing machines	Tubular bagging machines Single-axis motion control such as • Position profiles • Path profiles	Tubular bagging machines Single-axis motion control such as • Position profiles • Path profiles	Servo presses Rolling mill drives Multi-axis motion control such as • Multi-axis positioning • Cams • Interpolations
	V20 G120C	G120 G130/G150 G180 <sup>1)</sup>	S120 S150 DCM	V90 G120	S110 S210	S120 S210 DCM
<b>Machining</b>	Main drives for • Turning • Milling • Drilling	Main drives for • Drilling • Sawing	Main drives for • Turning • Milling • Drilling • Gear cutting • Grinding	Axis drives for • Turning • Milling • Drilling	Axis drives for • Drilling • Sawing	Axis drives for • Turning • Milling • Drilling • Laser cutting • Gear cutting • Grinding • Nibbling and punching
	S110	S110 S120	S120	S110	S110 S120	S120

#### Using the SINAMICS selection guide

The varying range of demands on modern variable frequency drives requires a large number of different types. Selecting the optimum drive has become a significantly more complex process. The application matrix shown simplifies this selection process considerably, by suggesting the ideal SINAMICS drive for examples of typical applications and requirements.

- The application type is selected from the vertical column
  - Pumping, ventilating, compressing
  - Moving
  - Processing
  - Machining
- The quality of the motion type is selected from the horizontal row
  - Basic
  - Medium
  - High

#### More Information

Further information about SINAMICS is available on the internet at [www.siemens.com/sinamics](http://www.siemens.com/sinamics)

Practical application examples and descriptions are available on the internet at [www.siemens.com/sinamics-applications](http://www.siemens.com/sinamics-applications)

<sup>1)</sup> Industry-specific converters.

<sup>2)</sup> Information on the SIMATIC ET 200pro FC-2 frequency converter is available in Catalog D 31.2 an on the internet [www.siemens.com/et200pro-fc](http://www.siemens.com/et200pro-fc)

## Overview

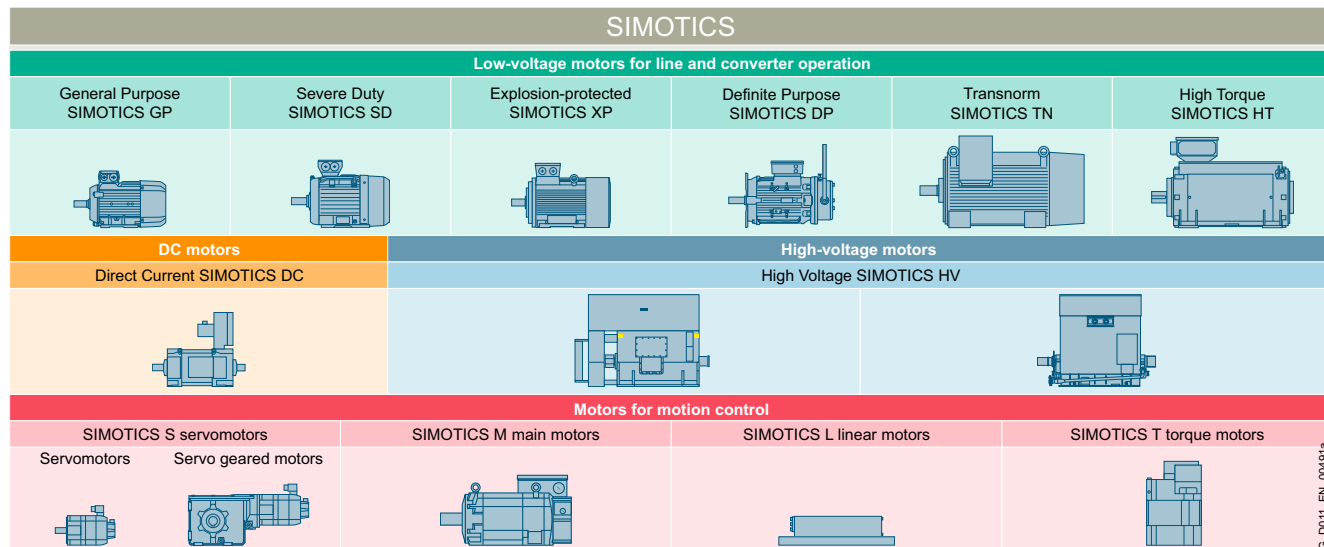

G\_DD11\_EN\_00491a

**SIMOTICS stands for**

- 150 years of experience in building electric motors
- The most comprehensive range of motors worldwide
- Optimum solutions in all industries, regions and power/performance classes
- Innovative motor technologies of the highest quality and reliability
- Highest dynamic performance, precision and efficiency together with the optimum degree of compactness
- Our motors can be integrated into the drive train as part of the overall system
- A global network of skill sets and worldwide service around the clock

**A clearly structured portfolio**

The entire SIMOTICS product portfolio is transparently organized according to application-specific criteria in order to help users select the optimum motor for their application.

The product range extends from standard motors for pumps, fans and compressors to highly dynamic, precise motion control motors for positioning tasks and motion control in handling applications, as well as production machinery and machine tools, to DC motors and powerful high-voltage motors. Whatever it is that you want to move – we can supply the right motor for the task.

[www.siemens.com/simotics](http://www.siemens.com/simotics)

**An outstanding performance for any job**

A key characteristic of all SIMOTICS motors is their quality. They are robust, reliable, dynamic and precise to assure the requisite performance level for any process and deliver exactly the capabilities demanded by the application in hand. Thanks to their compact design, they can be integrated as space-saving units into installations. Furthermore, their impressive energy efficiency makes them effective as a means of reducing operating costs and protecting the environment.

**A dense network of skill sets and servicing expertise around the world**

SIMOTICS offers not only a wealth of sound experience gleaned from a development history which stretches back over around 150 years, but also the know-how of hundreds of engineers. This knowledge and our worldwide presence form the basis for a unique proximity to industries which feeds through in tangible terms to the specific motor configuration which is tailored to suit your application.

Our specialists are available to answer all your queries regarding any aspect of motor technology. At any time – wherever you are in the world. When you choose SIMOTICS, therefore, you reap the benefits of a global service network which is continuously accessible, thereby helping to optimize response times and minimize downtimes.

**Perfection of the complete drive train**

SIMOTICS is perfectly coordinated with other Siemens product families. In combination with the SINAMICS integrated converter family and the SIRIUS complete portfolio of industrial controls, SIMOTICS fits seamlessly as part of the complete drive train into automation solutions which are based on the SIMATIC, SIMOTION and SINUMERIK control systems.

## SIMOGEAR geared motors

## Overview

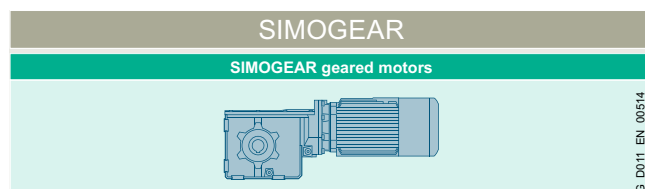

G\_DD11\_EN\_00514





The SIMOGEAR range of geared motors covers all common types such as helical, parallel shaft, bevel and worm geared motors and covers a power range from 0.09 kW to 55 kW and gearbox torques up to 19500 Nm. SIMOGEAR geared motors are fully compatible with many other manufacturers thanks to their market-standard connection dimensions.

[www.siemens.com/simogear](http://www.siemens.com/simogear)

## System overview

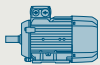
### SIMOTICS low-voltage motors for line and converter operation

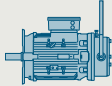
#### Overview

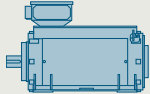
Low-voltage motors for line and converter operation					
General Purpose SIMOTICS GP	Severe Duty SIMOTICS SD	Explosion protected SIMOTICS XP	Definite Purpose SIMOTICS DP	Transnorm SIMOTICS TN	High Torque SIMOTICS HT
					
IEC: 0.09 ... 45 kW Reluctance: 0.55 ... 52 kW NEMA: 1 ... 200 hp	IEC: 0.09 ... 1000 kW Reluctance: 0.55 ... 52 kW NEMA: 1 ... 400 hp	IEC: 0.09 ... 1000 kW NEMA: 1 ... 300 hp	IEC: 1.1 ... 363 kW NEMA: 1 ... 200 hp	200 ... 3500 kW	150 ... 2100 kW
IEC: 0.59 ... 295 Nm Reluctance: 3.5 ... 191 Nm NEMA: 1.5 ... 883 lb-ft	IEC: 1.24 ... 8100 Nm Reluctance: 2,4 ... 1273 Nm NEMA: 1.5 ... 1483 lb-ft	IEC: 0.6 ... 8100 Nm NEMA: 1.5 ... 1187 lb-ft	IEC: 11 ... 3988 Nm NEMA: 1.5 ... 1104 lb-ft	642 ... 20864 Nm	6000 ... 42000 Nm
IEC: 750 ... 3000 rpm (at 50 Hz) Reluctance: 1500/1800/2610 rpm NEMA: 900 ... 3600 rpm (at 60 Hz)	IEC: 750 ... 3000 rpm (at 50 Hz) Reluctance: 1500/1800/2610/ 3000/3600 rpm NEMA: 900 ... 3600 rpm (at 60 Hz)	IEC: 750 ... 3000 rpm (at 50 Hz) NEMA: 900 ... 3600 rpm (at 60 Hz)	IEC: 750 ... 3000 rpm (at 50 Hz) NEMA: 900 ... 3600 rpm (at 60 Hz)	IEC: 750 ... 3000 rpm (at 50 Hz)	IEC: 200 ... 800 rpm (at 50 Hz)
Pumps, fans and compressors with especially low weight requirements	Pumps, fans, compressors, mixers, mills, extruders and rollers with special demands in terms of ruggedness, particularly in the chemical and petrochemical industries	General industrial applications with special requirements regarding explosion protection for use in Zones 1, 2, 21, and 22 such as in the process industry	Ships, work and transport roller tables, tunnels, multi-story car parks, shopping malls, dockside cranes, container terminals as well as motors customized for special applications	Pumps, fans, compressors, conveyor belts, mixers, extruders in the chem. and petrochem. industry, paper-making machines, mining, cement, steel industry, and marine applications including propulsion	High-torque gearless motors for paper-making machines, low-speed pumps, mills, steel shears, bow thrusters, winches or main drives on ships
IEC: D 81.1 NEMA: D 81.2	IEC: D 81.1 NEMA: D 81.2	IEC: D 81.1 NEMA: D 81.2	IEC: D 81.1, CR 81, ME 81 NEMA: D 81.2	D 81.1, D 84.1	D 86.2

G\_D011\_EN\_00516d

#### SIMOTICS GP and SIMOTICS SD

SIMOTICS GP General Purpose motors with an aluminum housing are suitable for a wide range of standard drive tasks in industrial environments. SIMOTICS SD Severe Duty motors with a cast-iron housing are extremely rugged and are therefore the first choice for applications in harsh environmental conditions.

SIMOTICS GP and SIMOTICS SD are fundamentally optimized for line operation. In addition, two converter-optimized motor lines are available for variable-speed converter-fed operation.

#### • Induction technology (VSD10 line)

The VSD10 line converter motors are designed exclusively for use on converters and are specially optimized for SINAMICS frequency converters. In terms of economy, efficiency and reliability, they are perfectly matched to SINAMICS G120 standard converters over the complete life cycle.

#### • Synchronous reluctance technology (VSD4000 line)

VSD4000 line reluctance motors are designed exclusively for use on converters and are specially optimized for SINAMICS G120. Compared to systems with induction motors, synchronous reluctance technology is characterized by particularly high efficiency levels, especially in the partial load range, and by high dynamics. The vector control of the frequency converter ensures optimal operating characteristics. More information on the reluctance drive system is available at [www.siemens.com/reluctance-drive-system](http://www.siemens.com/reluctance-drive-system)

#### SIMOTICS XP





Our rugged SIMOTICS XP explosion-proof motors are exceptionally durable, even in the harshest conditions, and absolutely fail-safe - in both line and converter operation.

SIMOTICS XP motors meet all requirements with maximum safety and maximum efficiency.

**Note:** Suitable for use with SINAMICS G120X only when installed in a safe area. Suitable for motors in an explosion-proof enclosure design.



## Overview

Motion Control Encoder measuring systems								
Encoder type	Incremental encoders			Absolute encoders				
								
Interface	sin/cos 1V <sub>pp</sub>	RS422 (TTL)	HTL	DRIVE-CLIQ	SSI	EnDat	PROFIBUS DP	PROFINET IO
Resolution	1000 S/R 1024 S/R 2500 S/R	500 S/R 1000 S/R 1024 S/R 1250 S/R 1500 S/R 2000 S/R 2048 S/R 2500 S/R 3600 S/R 5000 S/R	100 S/R 500 S/R 1000 S/R 2500 S/R	Single-turn 24 bit Multi-turn 36 bit (24 bit Single-turn + 12 bit Multi-turn)	Single-turn 13 bit (8192 steps)  Multi-turn 25 bit (8192 steps × 4096 revolutions)	Single-turn 13 bit (8192 steps)  Multi-turn 25 bit (8192 steps × 4096 revolutions)	Single-turn 13 bit (8192 steps)  Multi-turn 27 bit (8192 steps × 16384 revolutions)	Single-turn 13 bit (8192 steps)  Multi-turn 27 bit (8192 steps × 16384 revolutions)
Catalog	D 21.4							

Motion control encoders are optoelectronic built-on encoders that detect the traversing distances, angles of rotation, speeds or positions of machine axes. Motion control encoders are direct measuring systems that are built-on to shafts, axes or motors. They can be used in conjunction with numerical and programmable logic controllers, drives and position displays. Motion control encoders are system-tested, certified components that have been harmonized for use with the following systems:

- SINUMERIK CNC controls
- SIMOTION Motion Control Systems
- SIMATIC programmable logic controllers
- SINAMICS drive systems

Motion control encoders are used with machine tools and production machines as additional external measuring systems. They are available as incremental or absolute encoders.

- In the case of incremental encoders, the machine must travel to a reference point after each power-off state, as the position is not usually stored in the controller, and movements of the machine while the power is off are not recorded.
- Absolute encoders, on the other hand, also record movements while the power is off and return the actual position after power on. Travel to a reference point is not necessary.

All motion control encoders are available as Synchro flange and clamp flange versions. The absolute encoders are also available with a hollow shaft and torque arm.

The motion control encoders are driven via a plug-in coupling or spring disk coupling. Alternatively, pulleys can also be used.

The motor control encoder supply voltage is 5 V DC or alternatively 10 V to 30 V DC. The 10 V to 30 V DC version supports longer cable lengths. Most control systems supply the voltage directly at the measuring circuit connector. With SINAMICS, the measuring systems are provided with power via the converters or the Sensor Modules.

For motion control encoders with cables, the cable length including the connector is 1 m.

The following bending radii must be observed for the cable to the built-on encoder:

- One-time bending:  $\geq 20$  mm
- Continuous bending:  $\geq 75$  mm

**More Information**

- Internet:  
[www.siemens.com/sensor-systems](http://www.siemens.com/sensor-systems)  
[www.siemens.com/industrymall](http://www.siemens.com/industrymall)

## System overview

1

### MOTION-CONNECT connection systems

#### Overview

MOTION-CONNECT includes connection systems and components which are optimally tailored to individual areas of application. MOTION-CONNECT cables feature state-of-the-art connection systems to ensure fast, reliable connection of different components, and offer maximum quality as well as system-tested reliability.

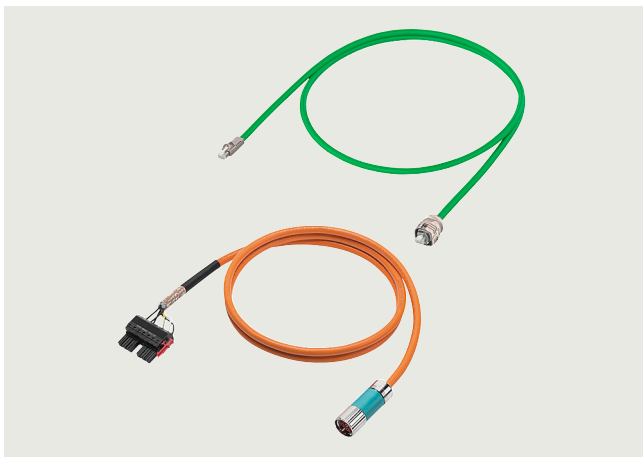

MOTION-CONNECT power cable and signal cable

MOTION-CONNECT cables are available as fully-assembled power and signal cables or sold by the meter. The pre-assembled cables can be ordered in length units of 10 cm (3.94 in) and can be extended, if necessary.

Whatever your machine requirements, MOTION-CONNECT offers the solution.

- **Robust, high-performance and easy to use**  
thanks to pre-assembled cables with a rugged metal connector in degree of protection IP67 and reliable SPEED-CONNECT quick-release lock
- **Outstanding and proven quality**  
achieved by consistent quality management and system-tested cables

Cables are available in two different qualities – MOTION-CONNECT 500 and MOTION-CONNECT 800PLUS.

MOTION-CONNECT 500	MOTION-CONNECT 800PLUS
<ul style="list-style-type: none"> <li>• Cost-effective solution for predominantly fixed installation</li> <li>• Tested for travel distances up to 5 m (16.4 ft)</li> </ul>	<ul style="list-style-type: none"> <li>• Meets requirements for use in cable carriers</li> <li>• Oil-resistant</li> <li>• Tested for travel distances of up to 50 m (164 ft)</li> </ul>

#### More Information

- Internet:  
[www.siemens.com/motion-connect](http://www.siemens.com/motion-connect)  
[www.siemens.com/industrymall](http://www.siemens.com/industrymall)

## Firmware functionality

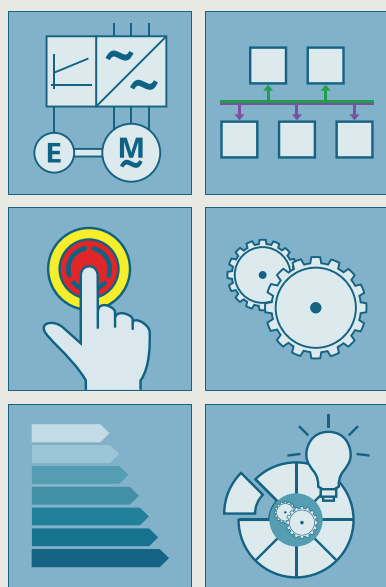

### 2/2

#### Firmware functionality

2/2

Introduction

2/2

Basic Drive Functions

2/4

Standard Technology Functions

2/5

Advanced Technology Functions

2/6

Common Engineering

2/6

Applications & Branch know-how

Further information about firmware functionality can be found on the internet at [www.siemens.com/sinamics-firmware](http://www.siemens.com/sinamics-firmware)

## Firmware functionality

### Firmware functionality

#### Overview

The major part of the functionality of SINAMICS drives is implemented in software. This "embedded" **software** delivers the function of the product and is therefore a significant component of the overall product. The embedded software is also known as **firmware**, because it is firmly connected to specific hardware.

In the case of SINAMICS drives, the firmware is subdivided into the **operating system (OS)** with drivers for the hardware and the converter functions, which are also referred to as the **runtime (RT) functions**.

#### Introduction

The available firmware functions are so extensive that the overall functional scope has been structured into function groups corresponding to their main applications.

The 8 main groups are:

- Basic Drive Functions
- Standard Technology Functions
- Advanced Technology Functions
- Communication Functions
- Safety Integrated Functions
- Energy Efficiency Functions
- Common Engineering
- Applications & Branch know-how

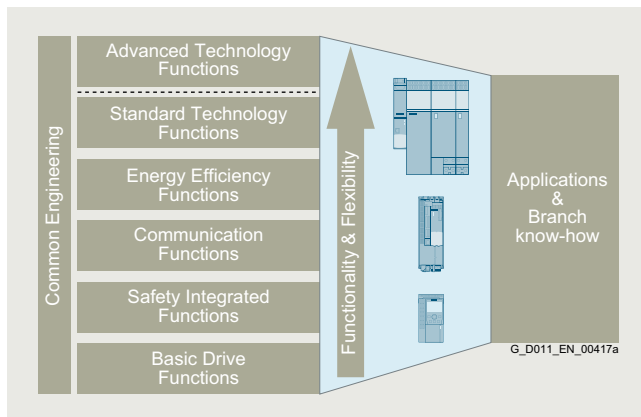

Functionality, including technology and configuration

#### Basic Drive Functions

The main groups, especially the "Basic Drive Functions", are divided up into further subgroups.

- Control modes
- Availability
- Setpoints and commands
- Limiters, timers and monitoring functions
- Diagnostics
- Protection

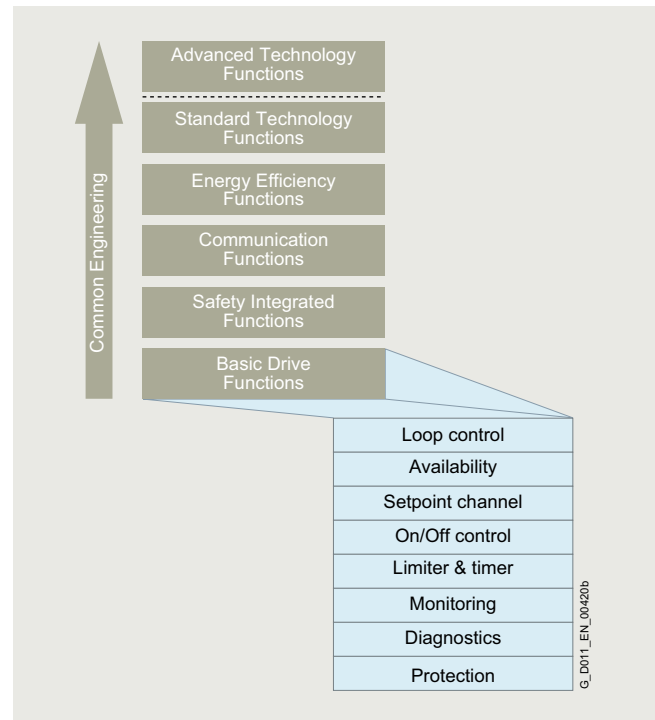

Basic Drive Functions - Control Functions

#### Control modes

The control methods are the core of the entire converter firmware. They are responsible for optimum movement of the connected motor and the attached machines. The better the control functions, the faster, better and more smoothly the machine operates, thereby significantly enhancing the quality of the production output.

A distinction is made between the following methods:

- V/f control (open-loop control)
- Vector control (closed-loop control)
- Servo control (closed-loop control)

Further classification refers to the control variables:

- Current control
- Speed control
- Torque control
- Position control
- Technological process control (pressure, flow rate, temperature, fill level, etc.)

## Overview

### Availability

Availability refers to the frequency ratio, namely how often or seldom a single device restricts the entire production process due to a problem. That is why it is important in terms of availability that a drive enters the faulty state only when it is essential for self-protection. Moreover, it is important that the cause of the pending problem is identified and eliminated as quickly as possible.

Features and measures to increase availability:

- Parallel connections, for example, to maintain emergency operation (possibly also at a lower rating), if a power unit fails
- Automatic restart
- Flying restart
- $V_{dc}$  control with kinetic buffering
- Redundancy (hardware, communication, etc.)

### Setpoints and commands

The setpoint channel is the link between the setpoint source and the motor control. The converter has a special feature that supports simultaneous input of two setpoints. Generation and subsequent modification of the total setpoint (influencing the direction, skip frequency, up/down ramp) take place in the setpoint channel.

Different sources of command usually result from the requirements to operate a drive from different places (on-site/remote), in different situations (standard/emergency mode) and/or different operating. The BICO binector connector technology allows SINAMICS to configure and combine the command and setpoint sources completely individually.

The following can be used for switching:

- Dataset switchover
- Switching elements among the Free Function Blocks (FFB)
- Fixed values

### Limiters and monitoring functions

Limiters or limits are used to constrain input and/or output variables as appropriate to the connected machine; this means that not all positioning variables are used over their full range but are limited judiciously to enhance the safety and quality of the production process.

Timers/runtime counters are used to obtain information or make statements about the temporal course of a process.

- Recording application information for manufacturers
- Recording operating times for users
- Configurable timers for monitoring intervals
- Configurable timers for triggering activities at certain intervals (e.g. maintenance work)

Monitoring is used for early detection of conditions that may be detrimental or even dangerous to the connected machine, so that they can be counteracted expediently. If an appropriate countermeasure is not initiated, a protective response of the converter with probable fault shutdown will ultimately result.

### Diagnostics

The "Diagnostics" subgroup comprises all those functions that provide assistance with determining the possible causes of a problem.

If problems occur in a process, or in the driven machine, further interpretation of the measured variables in the converter is required. To this end, different signals should be correlated with respect to time and then observed.

This includes:

- Error and alarm buffer
- Diagnostic buffer
- List of missing signals that interrupt operation
- Tracing for temporal assignment of signal profiles
- I/O simulation
- Telegram content diagnoses
- Terminal status

### Protection

All protection functions counteract any possible damage to the converter and/or motor. This is why the shutdown thresholds cannot be parameterized but are factory-tuned and permanently set to match the built-in components. Alarm thresholds may be parameterized as a relative variable for shutdown threshold of some monitoring processes. Thus, a countermeasure that is sensitive to the process may still be initiated upon occurrence of the alarm.

Apart from protection of the hardware, protection of the parameterization and therefore protection of the intellectual expertise of the customer from unauthorized access and copying is also an important part of the protection functions.

- Write protection
- Know-how protection
- Copy protection

## Firmware functionality

### Firmware functionality

#### Overview

#### Standard Technology Functions

The Standard Technology Functions are not restricted to a specific SINAMICS product family, but they are available in full or at least partially in SINAMICS S120 as well as in SINAMICS G120.

- BICO technology
- Free function blocks (FFB)
- Basic positioner (EPos)
- Technology controller (PID)

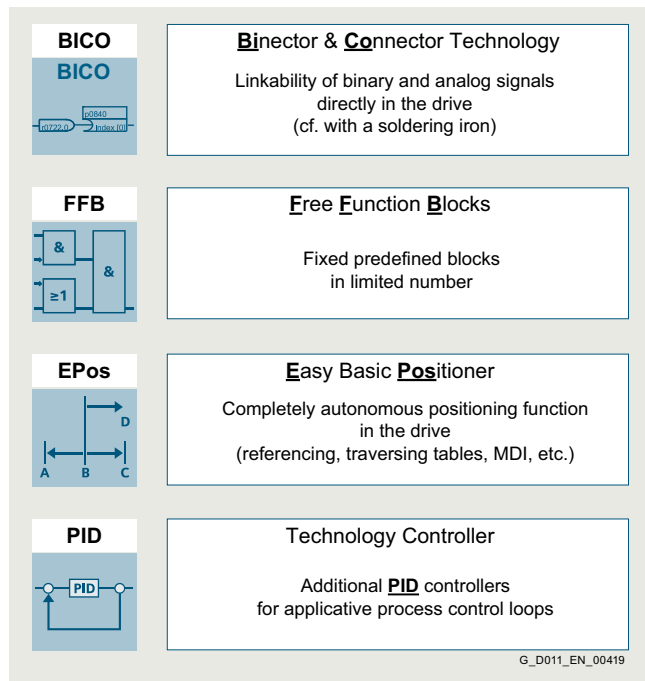

Standard Technology Functions

The Standard Technology Functions significantly expand the application spectrum of the SINAMICS drives because the functions are not permanently and unalterably interconnected; rather, they are interrupted at defined access points and can be connected or wired differently. The BICO technology makes it possible.

The FFBs enable additional, freely interpretable adaptations of the binary and analog signal flow to the given machine application. However, the FFBs are limited in terms of the absolute quantity and the computing intervals (sampling times) that can be selected. These blocks are NOT multi-instance capable.

With EPos, comprehensive positioning tasks are autonomous in SINAMICS (i.e. their solution does not need a higher-level control). And moreover, this integrated functionality is also extremely flexible: It can be used for highly dynamic servo control as well as for simple applications with vector-controlled asynchronous motors. Up to 64 target positions, as well as the respective traversing speeds, can be permanently stored in the drive during commissioning. Axes can be positioned either absolutely or relatively.

It is, however, also possible to transfer these parameters as required from a higher-level controller. This means that target positions and velocities can even be changed on-the-fly during a positioning run.

The technology controller (PID controller) permits all types of simple process controls to be implemented. It can be used, for example, to control the line pressure, fill level, temperature, flow or also tension control or load balancing.

For more information, see [section Technology functions](#).

**Overview**

**Advanced Technology Functions**

The Advanced Technology Functions are the clear differentiating feature between the SINAMICS product families of SINAMICS G120 with the CU2xx-2 Control Units and SINAMICS S120 with the CU3x0-2 Control Units. The Advanced Technology Functions are only available for SINAMICS S120:

- SINAMICS Drive Control Chart (DCC)
- SINAMICS Technology Extensions (TEC)

The Advanced Technology Functions are characterized by maximum flexibility and performance whereby extremely individual and, at the same time, efficient solutions can be achieved.

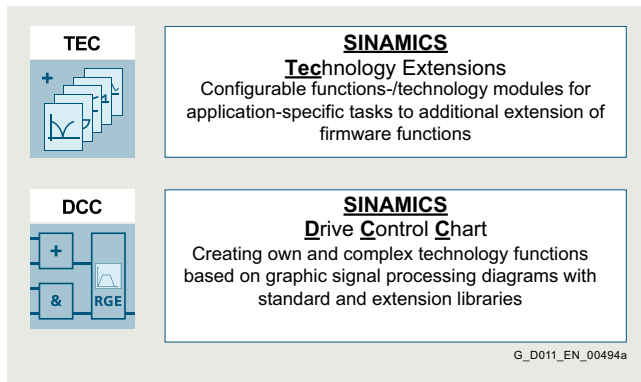

Advanced Technology Functions

SINAMICS DCC comprises the block library, so-called DCB Drive Control Blocks and the DCC Editor for graphical inter-connection of blocks. SINAMICS DCC is primarily employed to solve arithmetic and control-related tasks or logic functions associated with complex applications.

In addition to the DCB Standard library, the DCB Extension library can also be used to create applications. The DCB Extension library is comprised of freely programmable blocks which are created for specific applications using DCB Studio and are then graphically interconnected with the DCC Editor in a similar fashion to standard blocks.

SINAMICS Technology Extensions (TECs) are configurable firmware expansions that are specifically created for use in a customized application with special requirements. This functionality can therefore be subsequently installed as an add-on to the standard scope of firmware functions. One example of a SINAMICS TEC is the VIBX vibration extinction for storage and retrieval systems.

For more information, see section [Technology functions](#).

The functional scope of Advanced Technology Functions is scalable and flexible. Depending on the task, you can choose between configurable solutions provided by Siemens or freely created proprietary solutions in the drive.

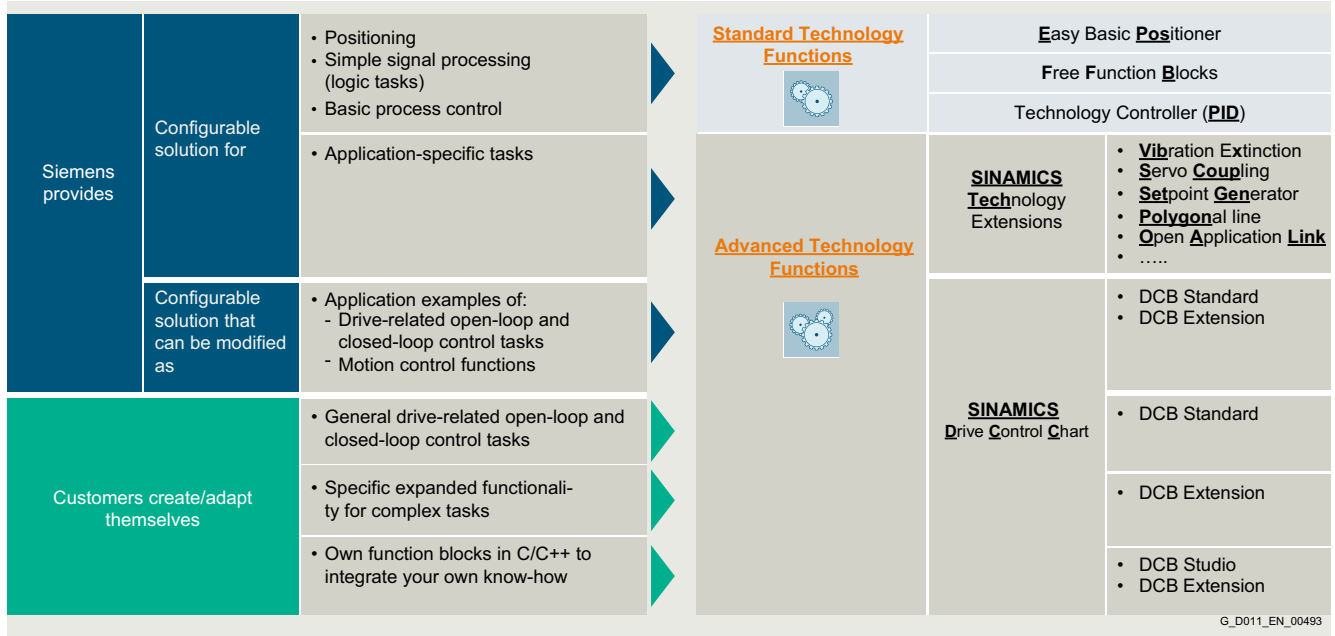

Depending on the technology function, a license may be required for the application.

## Firmware functionality

### Firmware functionality

#### Overview

##### **Safety Integrated Functions**

See section [Safety Integrated](#)

##### **Communication Functions**

See section [Communication](#)

##### **Energy Efficiency Functions**

See section [Energy efficiency](#)

##### **Common Engineering**

All functions of the converters are implemented to enable a common engineering approach to their handling no matter which type of drive is selected; i.e. if a function is used in drive x, it can be configured intuitively and commissioned in the same way in drive y. Knowledge gained can therefore be reused easily and efficiently. The configuration and commissioning tools in particular (such as SIZER for Siemens Drives (integrated in TIA Selection Tool), STARTER and SINAMICS Startdrive) reflect this approach.

For more information, see section [Engineering tools](#).

##### **Applications & Branch know-how**

Siemens has applied these technology functions (standard and/or advanced) to generate numerous application solutions.

These applications can be downloaded from the Siemens application support website at [www.siemens.com/sinamics-applications](http://www.siemens.com/sinamics-applications)

The STARTER and SINAMICS Startdrive commissioning tools can then be used to activate and configure the applications and download them to the Control Units.

#### More information

Further information about firmware functionality can be found on the internet at [www.siemens.com/sinamics-firmware](http://www.siemens.com/sinamics-firmware)

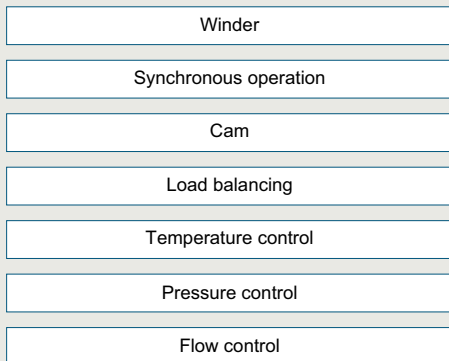

#### **Applications & Branch know-how**

Cascade control, bypass, multi-zone control, hibernation, essential service mode ESM, wobble generator

Line infeed functions, e.g. line transformer, dynamic grid support, ...

G\_D011\_EN\_004218

#### Applications & Branch know-how

Depending on the technology function, a license may be required for the application.

In some branch-specific Control Units (e.g. CU230P-2) branch-specific functions are also an integral part of the firmware.

For more information, see section [Drive applications](#).

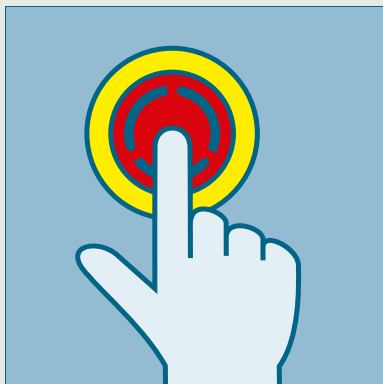

## Safety Integrated

**3/2 Safety Integrated**

3/2 Overview

3/3 Function

3/13 Integration

3/13 More information

**3/14 Safety Integrated for SINAMICS G120C**

3/14 Overview

3/14 Function

**3/15 Safety Integrated for SINAMICS G120**

3/15 Overview

3/16 Benefits

3/18 Function

**3/19 Safety Integrated for SINAMICS S110**

3/19 Overview

3/20 Function

The Safety Integrated Function Manual contains detailed information about the safety functions.

<https://support.industry.siemens.com/cs/document/109781722>

Further manuals pertaining to Safety Integrated in drive systems can be found on the internet at

<https://support.industry.siemens.com/cs/ww/en/ps/13206/man>

Further information about Safety Integrated in SINAMICS can be found on the internet at [www.siemens.com/safety-drives](http://www.siemens.com/safety-drives)

## Safety Integrated

### Safety Integrated

#### Overview



#### Legal framework

Machine manufacturers and plant construction companies must ensure that their machines or plants cannot cause danger due to malfunctions in addition to the general risks of electric shock, heat or radiation.

In Europe, for example, compliance with the Machinery Directive 2006/42/EC is legally stipulated by the EU framework directive for occupational safety. In order to ensure compliance with this directive, it is recommended that the corresponding harmonized European standards are applied. This triggers the "assumption of conformity" and gives manufacturers and operators the legal security in terms of compliance with both national regulations and EU directives. The machine manufacturer uses the CE marking to document compliance with all relevant directives and regulations in the free movement of goods.

#### Safety-related standards

Functional safety is specified in various standards. For example, EN ISO 12100 specifies standards pertaining to machine safety (risk assessment and risk reduction). IEC 61508 specifies basic requirements for electronic and programmable safety-related systems. EN 62061 (only applicable for electrical and electronic control systems) and EN ISO 13849-1 define the functional and safety-related requirements of safety-oriented control systems.

The above-mentioned standards define different safety requirements that the machine has to satisfy in accordance with the risk, frequency of a dangerous situation, probability of occurrence and the opportunities for recognizing impending danger.

- EN ISO 13849-1:  
Performance Level PL a ... e;  
Category B, 1 ... 4
- EN 62061:  
Safety Integrity Level SIL 1 ... 3

#### Trend toward integrated safety systems

The trend toward greater complexity and higher modularity of machines has seen a shift in safety functions away from the classical central safety functions (for example, shutdown of the complete machine using a main disconnecting means) and into the machine control system and the drives. This is often accompanied by a significant increase in productivity because the setup times are shortened. Depending on the type of machine, it may even be possible to continue manufacturing other parts while the setup is in progress.

Safety Integrated Functions act much faster than those of a conventional design. The safety of a machine is increased further with Safety Integrated. Furthermore, thanks to the faster method of operation, safety measures controlled by integrated safety systems are perceived as less of a hindrance by the machine operator, therefore significantly reducing the motivation to consciously bypass safety functions.

## Function

### Safety functions integrated in SINAMICS drives

SINAMICS drives are characterized by a large number of Safety Integrated Functions. In combination with the sensors and safety control required for the safety functionality, they ensure that highly-effective protection for persons and machines is implemented in a practice-oriented manner.

They comply with the requirements of the following safety categories:

- PL d and Category 3 according to EN ISO 13849-1
- SIL 2 according to IEC 61508 and IEC 61800-5-2

#### Note:

The Safe Brake Test (SBT) diagnostic function meets the requirements for Category 2 according to EN ISO 13849-1. The PM240-2 Power Modules, frame sizes FSD to FSG additionally offer STO acc. to IEC 61508 SIL 3 and EN ISO 13849-1 PL e and Category 3.

The Safety Integrated functions are generally certified by independent institutes. You can obtain the corresponding test certificates and manufacturer's declarations from your Siemens contacts.

The Safety Integrated Functions that are currently available are described below. Their functional safety satisfies the requirements defined in the international standard IEC 61800-5-2 for variable-speed drive systems.

The safety functions integrated into the SINAMICS drive system can be roughly divided into four categories:

- **Functions for safely stopping a drive**
  - Safe Torque Off (STO)
  - Safe Stop 1 (SS1)
  - Safe Stop 2 (SS2)
  - Safe Operating Stop (SOS)
- **Functions for safe brake management**
  - Safe Brake Control (SBC)
  - Safe Brake Test (SBT)  
(this diagnostic function exceeds the scope of IEC 61800-5-2)
- **Functions for safely monitoring the motion of a drive**
  - Safely-Limited Speed (SLS)
  - Safe Speed Monitor (SSM)
  - Safe Direction (SDI)
  - Safely-Limited Acceleration (SLA)
- **Functions for safely monitoring the position of a drive**
  - Safely-Limited Position (SLP)
  - Safe Position (SP) (this function exceeds the scope of IEC 61800-5-2)
  - Safe Cam (SCA)

### Safe Torque Off (STO)

The STO function is the most common and basic drive-integrated safety function. It ensures that no torque-generating energy can continue to affect a motor and prevents unintentional start-ups.

#### Effect

This function is a mechanism that prevents the drive from restarting unexpectedly, in accordance with EN 60204-1, Section 5.4. The STO function suppresses the drive pulses (corresponds to Stop Category 0 according to EN 60204-1). The drive is reliably torque-free. This state is monitored internally in the drive.

#### Application

STO has the immediate effect that the drive cannot supply any torque-generating energy. STO can be used wherever the drive will naturally reach a standstill due to load torque or friction in a sufficiently short time or when "coasting down" of the drive will not have any relevance for safety.

STO makes it possible for persons to work safely when the protective door is open (restart interlock) and is used on machines/installations with moving axes, e.g. on handling or conveyor systems.

#### Customer benefits

Some of the advantages of the Safety Integrated Function STO over conventional safety technology with electromechanical switchgear include the elimination of separate components as well as of the work that would be required to wire and service them, i.e. no wearing parts as a result of the electronic shutdown. Because of the fast electronic switching times, the function provides a shorter reaction time than the conventional solution comprising electromechanical components. When STO is triggered, the converter remains connected to the network and can be fully diagnosed.

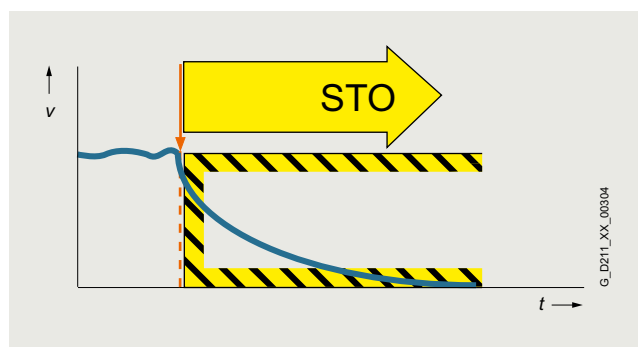

## Safety Integrated

### Safety Integrated

#### Function

##### Safe Stop 1 (SS1)

The SS1 function causes a motor to stop rapidly and safely and switches the motor to torque-free mode after coming to a standstill by activating STO.

##### Effect

The SS1 function can safely stop the drive in accordance with EN 60204-1, Stop Category 1. When the SS1 function is selected, the drive brakes autonomously along a quick-stop ramp and automatically activates the Safe Torque Off and Safe Brake Control functions (if configured) when the parameterized safety delay time expires.

If the variant "SS1 with external stop (SS1E)" is parameterized, the drive does not brake autonomously when the function is selected. In this case, the higher-level control must bring the drive to a standstill within a parameterized STO transition time. The SBR (Safe Brake Ramp) and SAM (Safe Acceleration Monitor) functions are not active. SS1E is a useful function for drives that need to be stopped as a group by the Motion Control system in order to prevent potential damage to the machine or product.

##### Application

The SS1 function is used when, in the event of a safety-relevant incident, the drive must stop as quickly as possible with a subsequent transition into the STO state (e.g. EMERGENCY STOP). It is thus used to bring large centrifugal masses to a stop as quickly as possible for the safety of the operating personnel, or to brake motors at high speeds as quickly as possible. Examples of typical applications are saws, grinding machine spindles, centrifuges, winders and storage and retrieval machines.

##### Customer benefits

The targeted stopping of a drive by means of SS1 reduces the risk of danger, increases the productivity of a machine, and allows the safety clearances in a machine to be reduced. The principle is to bring the drive actively to a standstill, compared with just using the STO function. Complex mechanical brakes that are susceptible to wear are normally not required to brake the motor.

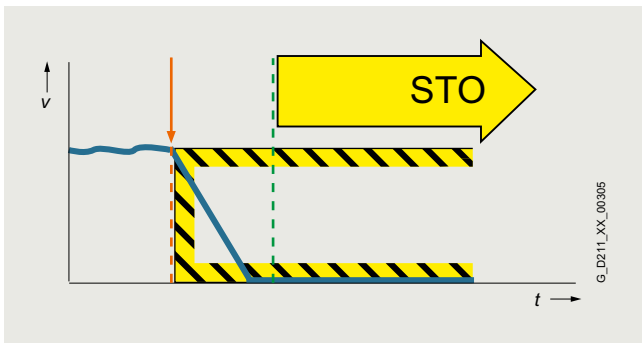

##### Safe Stop 2 (SS2)

The SS2 function brings the motor to a standstill quickly and safely and then activates the SOS function once the motor has stopped.

##### Effect

The Safe Stop 2 function can safely stop the drive in accordance with EN 60204-1, Stop Category 2. When the SS2 function is selected, the drive brakes autonomously along a quick stop ramp. In contrast to SS1, the drive control remains operational afterwards, i.e. the motor can supply the full torque required to maintain zero speed. Standstill is safely monitored (Safe Operating Stop function).

If the variant "SS2 with external stop (SS2E)" is parameterized, the drive does not brake autonomously when the function is selected. In this case, the higher-level control must bring the drive to a standstill within a parameterized Safe Operating Stop transition time. The SBR (Safe Brake Ramp) and SAM (Safe Acceleration Monitor) functions are not active. SS2E is a useful function for drives that need to be stopped as a group by the Motion Control system in order to prevent potential damage to the machine or product.

##### Application

As with SS1, the SS2 function ensures the quickest possible deceleration of the motor. However, the motor power is not switched off. Instead, a control system prevents it from leaving the standstill position – even if it is affected by external forces. Typical applications for SS2 include machine tools, for example.

##### Customer benefits

The SS2 function ensures a rapid axis stop. Because the control remains active, after the safety function is deselected, productive operation can continue without referencing. This ensures short setup and standstill times and high productivity.

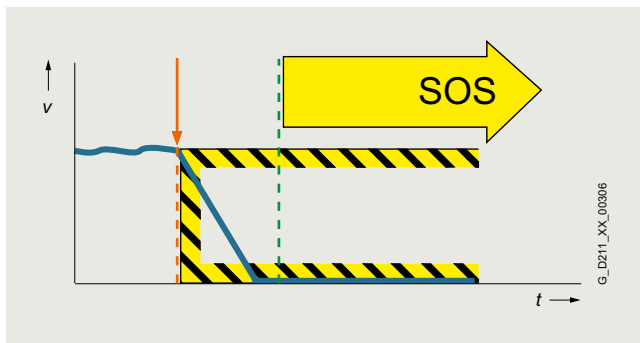

**Function****Safe Operating Stop (SOS)**

With the SOS function, the stopped motor is held in position by the drive control system and its position is monitored.

Effect

The SOS function constitutes safe standstill monitoring. The drive control remains in operation. The motor can therefore deliver the full torque to hold the current position. The actual position is reliably monitored. In contrast to safety functions SS1 and SS2, the speed setpoint is not influenced autonomously. After SOS has been activated, the higher-level control must bring the drive to a standstill within a parameterized time and then hold the position setpoint.

Application

SOS is an ideal solution for all those applications for which the machine or parts of the machine must be at a safe standstill for certain steps, but the drive must also supply a holding torque. It is ensured that despite counter torque the drive remains in its current position. In contrast to SS1 and SS2, the drive does not brake autonomously in this case. It expects the higher-level controller to ramp down the relevant axes as a coordinated group within an adjustable delay time. This can be used to prevent any damage to the machine or product. Typical applications for SOS include winders, converting and packaging machines and machine tools.

Customer benefits

No mechanical components are necessary to keep the axis in position despite any counterforce that may occur. Due to the short switching times and the fact that the drive control always remains active, setup and downtimes are reduced. Recalibration of the axis after exiting the SOS function is not necessary. The axis can immediately be moved again after deactivation of the SOS function.

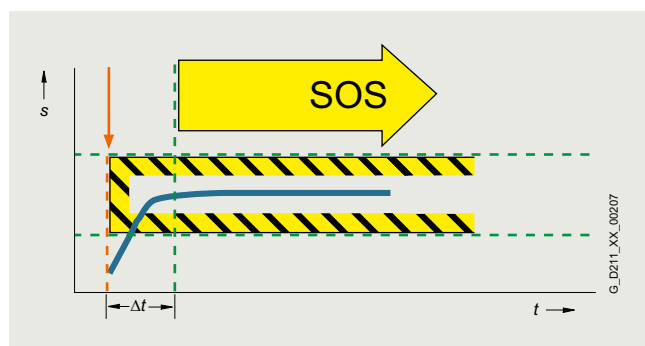
**Safe Brake Control (SBC)**

The SBC function permits the safe control of a holding brake. SBC is always activated in parallel with STO.

Effect

A holding brake which is active in a de-energized state is controlled and monitored using safe two-channel technology. Due to the two-channel control, the brake may still be activated in the event of an insulation fault in the control cable. Errors of this kind are detected early by means of test pulses.

Note:

Safe Brake Control does not detect mechanical faults in the brake itself, such as worn brake linings. For Motor Modules in booksize format, the terminals for the motor brake are integrated. An additional Safe Brake Relay is required for Power Modules in blocksize format. An additional Safe Brake Adapter is necessary for Power Modules in chassis format.

Application

The SBC function is used in conjunction with the functions STO or SS1 to prevent the movement of an axis in the torque-free state, e.g. because of gravity.

Customer benefits

Again, the function saves the use of external hardware and the associated wiring.

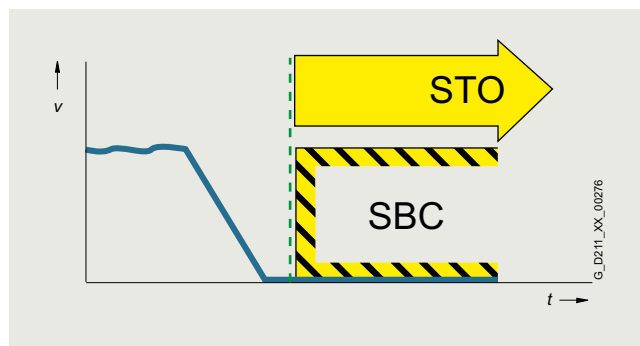

## Safety Integrated

### Safety Integrated

#### Function

##### Safe Brake Test (SBT)

The SBT diagnostic function carries out a brake function test at regular intervals or before personnel enter the danger zone.

##### Effect

A good way to check the proper functioning of brakes that have become worn is to apply a torque to the closed brake. Drive systems that have two brakes, e.g. motor brake and external brake, can be tested with different torque values.

##### Application

The SBT diagnostic function is suitable for implementing a safe brake in combination with the SBC function.

##### Customer benefits

The function detects faults or wear in the brake mechanics. Automatically testing the effectiveness of brakes reduces maintenance costs and increases the safety and availability of the machine or plant.

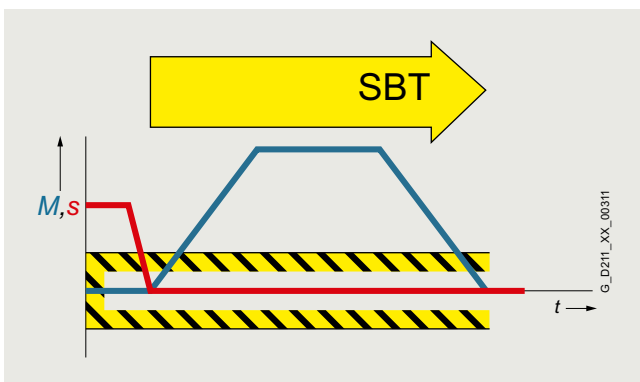

##### Safely-Limited Speed (SLS)

The SLS function monitors the drive to ensure that it does not exceed a preset speed or velocity limit.

##### Effect

The SLS function monitors the drive against a parameterized speed limit. Four different limit values can be selected. As in the case of SOS, the speed setpoint is not influenced independently. After SLS has been selected, the higher-level control must bring the drive down below the selected speed limit within a parameterizable time. If the speed limit is exceeded, a customizable drive-integrated fault reaction occurs.

The SLS limit stage 1 can be multiplied by a factor that is transferred in 16-bit resolution via PROFIsafe. This allows an almost unlimited number of limits to be specified.

##### Application

The SLS function is used if people are in the danger zone of a machine and their safety can only be guaranteed by reduced speed. Typical application cases include those in which an operator must enter the danger zone of the machine for the purposes of maintenance or setting up, such as a winder in which the material is manually threaded by the operator. To prevent injury to the operator, the roller may only spin at a safely reduced speed. SLS is often also used as part of a two-stage safety concept. While a person is in a less critical zone, the SLS function is activated, and the drives are only stopped safely in a smaller area with higher potential risk. SLS can be used not only for operator protection, but also for machinery protection, e.g. if a maximum speed must not be exceeded.

##### Customer benefits

The SLS function can contribute to a significant reduction in downtime, or greatly simplify or even accelerate setup. The overall effect achieved is a higher availability of the machine. Moreover, external components such as speed monitors can be omitted.

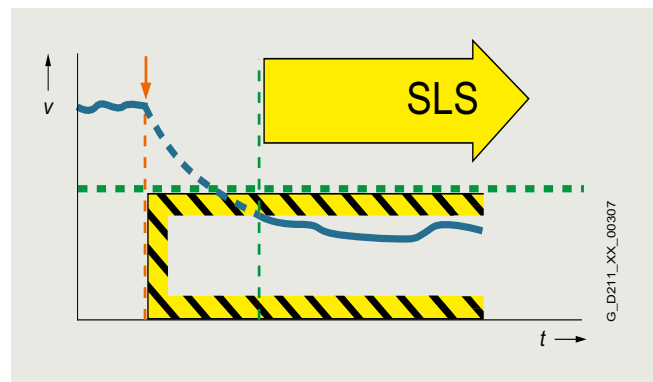

## Function

### Safe Speed Monitor (SSM)

The SSM function warns when a drive is working below an adjustable speed limit. As long as it remains below the threshold, the function issues a safety-related signal.

#### Effect

If a speed value drops below a parameterized limit, a safety-related signal is generated. This can, for example, be processed in a safety control unit to respond to the event by programming, depending on the situation.

#### Application

With the SSM function, in the simplest case, a safety door can be unlocked if the speed drops below a non-critical level. Another typical example is that of a centrifuge that may be filled only when it is operating below a configured speed limit.

#### Customer benefits

Unlike SLS, there is no drive-integrated fault reaction when the speed limit is exceeded. The safe feedback can be evaluated in a safety control unit, allowing the user to respond appropriately to the situation.

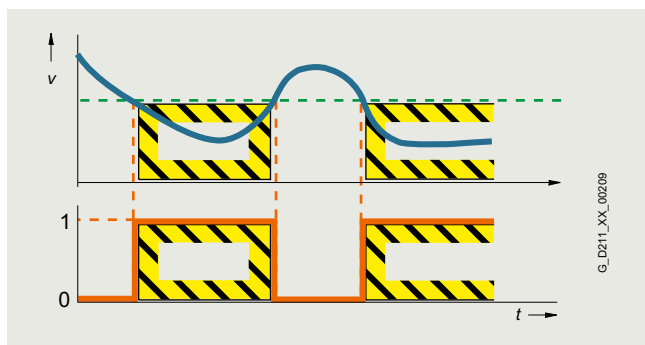

### Safe Direction (SDI)

The SDI function ensures that the drive can only move in the selected direction.

#### Effect

Deviation from the direction of motion currently being monitored is detected reliably and the configured drive-integrated fault reaction is initiated. It is possible to select which direction of rotation is to be monitored.

#### Application

The SDI function is used when the drive may only move in one direction. A typical application is to permit the operator access to a danger zone, as long as the machine is rotating in the safe direction, i.e. away from the operator. In this state, the operator can feed material into the work zone or remove material from the work zone without danger.

#### Customer benefits

The function saves the use of external components such as speed monitors and the associated wiring. The release of a danger zone while the machine is moving away from the operator increases productivity. Without the SDI function, the machine must be safely stopped during material loading and removal.

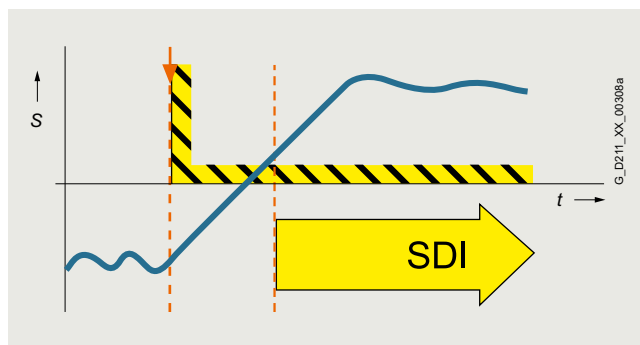

## Safety Integrated

### Safety Integrated

#### Function

##### **Safely-Limited Acceleration (SLA)**

The SLA function monitors that the drive does not exceed a pre-set acceleration limit value.

##### Effect

The SLA function monitors that the motor does not violate the defined acceleration limit (e.g. in setup mode). SLA detects early on whether the speed is increasing at an inadmissible rate (the drive accelerates uncontrollably) and initiates the stop response.

##### Application

The SLA function is used, e.g., for SIMATIC Safe Kinematics. SLA can only be used in safety systems with an encoder.

##### Customer benefits

The function monitors for maximum permissible acceleration in setup mode and safe monitoring of the tool center point with different kinematics.

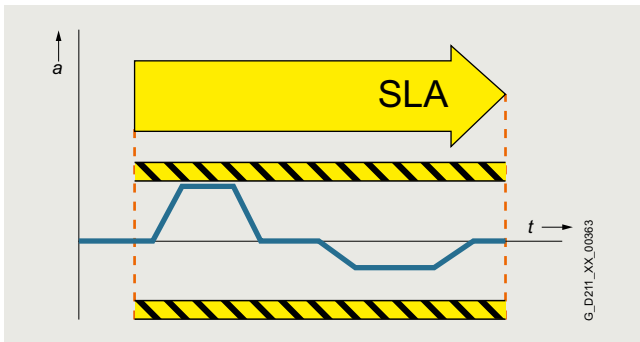

##### **Safely-Limited Position (SLP)**

The SLP function monitors the axis to ensure that it remains within the permissible traversing range.

##### Effect

When SLP is activated, the traversing range limited by the configured software limit switches is safely monitored. If the permitted traversing range is exited, a configurable fault reaction occurs. It is possible to toggle between two traversing ranges, even when the machine is in operation.

##### Application

SLP is used for applications in which machine operators have to enter a protection area, e.g. for feeding in and removing material. Safe monitoring of the axis position ensures that the axis cannot move into the protection area released for operators and so place them in danger, for example, on storage and retrieval machines, gantry cranes or machining centers.

##### Customer benefits

SLP can be used for highly-effective protection area monitoring. The function does away with the use of external components such as hardware limit switches and the associated wiring expense. Due to the short reaction time following a limit overshoot, safety clearances can be reduced.

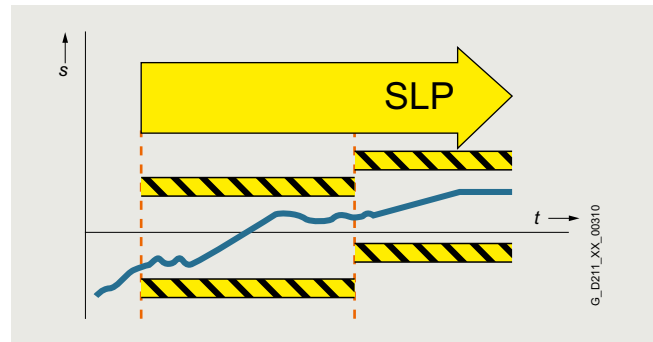



## Function

### Safe Position (SP)

The SP function transfers the actual position values determined safely in the drive over safe PROFIsafe communication to a safety control.

#### Effect

In contrast to the SLP function that monitors the current actual position value against a limit and, in the case of an overshoot, activates a drive-integrated fault reaction, SP transfers the current actual position values to the safety control. Position monitoring is implemented in the safety program of the control. Extended PROFIsafe telegrams are available for transferring the position values. The position values can be transferred in 16-bit or 32-bit resolution, as required. A time stamp is also transferred with the position values.

#### Application

Tailor-made safety concepts can be created using the SP function. It is ideal for use on machines that require flexible safety functions. It is extremely versatile and can be used, for example, to implement safe, axis-specific range detection by means of safe cams. The SP function can also be used to implement multi-axis safety concepts, multi-dimensional protection areas and zone concepts.

#### Customer benefits

Position monitoring or speed monitoring is implemented in the safety program of the control, so the user has the flexibility for implementing tailor-made safety functions. The reaction to a limit overshoot must also be specified in the safety program. This means a higher initial programming outlay, but it does offer the opportunity for initiating different fault reactions depending on the situation.

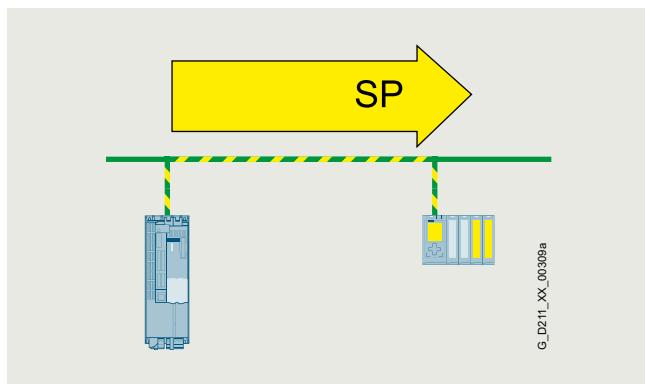

### Safe Cam (SCA)

The SCA function enables safety-related monitoring of the position.

#### Effect

The SCA function outputs a safe signal if the drive is within a specified position range. It facilitates the realization of safe axis-specific range detection. Up to 30 safe cams can be parameterized per axis.

#### Application

It is only permissible that a protective door is opened if a drive is in a certain position range. The drive may only be traversed with reduced speed when it is located in a certain position range.

#### Customer benefits

The function enables safety-related switchover of safety functions. With SCA, safe electronic cam controllers can be implemented without additional hardware. With SCA, work and protection zone delimitations are reliably detected.

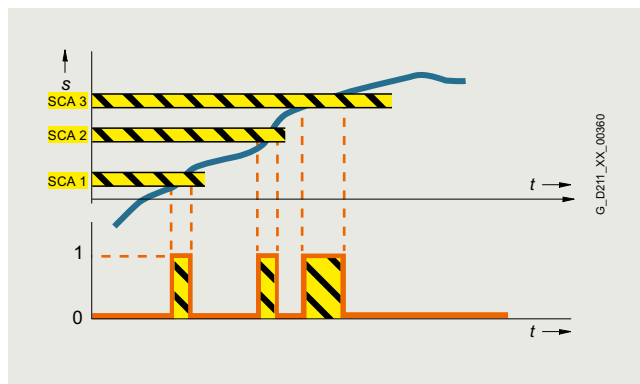

## Safety Integrated

### Safety Integrated

#### Function

##### **Basic Functions, Extended Functions, and Advanced Functions**

With SINAMICS G converters, the safety functions are basically implemented without encoders.

With SINAMICS S drives, the safety functions are implemented with encoders – individual safety functions can also be operated without encoders.

The Safety Integrated Functions are grouped into Basic Functions, Extended Functions, and Advanced Functions.

The Basic Functions are included in the standard scope of supply.

The Extended Functions must be activated by a license <sup>1)</sup>. The Advanced Functions for SINAMICS S120 must also be activated via a license.

The electronic Certificate of License is the paperless delivery form for runtime options for SINAMICS and contains information about the type of rights of use purchased for the software.

- Basic Functions
  - Safe Torque Off (STO)
  - Safe Brake Control (SBC)
  - Safe Stop 1 (SS1)
- Extended Functions
  - Safe Stop 1 with external stop (SS1E)
  - Safe Stop 1 (SS1) with SBR or SAM
  - Safe Stop 2 with external stop (SS2E)
  - Safe Stop 2 (SS2) with SBR or SAM
  - Safe Operating Stop (SOS)
  - Safely-Limited Speed (SLS)
  - Safe Speed Monitor (SSM)
  - Safe Direction (SDI)
  - Safely-Limited Acceleration (SLA)
  - Safe Brake Test (SBT) diagnostic function
- Advanced Functions
  - Safely-Limited Position (SLP)
  - Safe Position (SP)
  - Safe Cam (SCA)

The license for Safety Integrated Advanced Functions also includes the license for Safety Integrated Extended Functions.

For the Extended Functions SS1 and SS2 with SAM, Safe Acceleration Monitor (SAM) is performed during braking to identify any faults already during the braking phase.

With SS1 and SS2, a Safe Brake Ramp (SBR) can be configured as an alternative.

The Basic Functions – activated via on-board terminals on the device, TM54F Terminal Module (only for SINAMICS S) or via PROFIsafe – do not require an encoder.

##### **Activation of the Safety Integrated Functions**

The safety functions for SINAMICS drives can be activated via terminals, e.g. for use of a conventional safety circuit.

For standalone safety solutions for small to medium-sized applications, it is frequently sufficient that the various sensing components are directly hardwired to the drive.

For integrated safety solutions, the safety-relevant sequences are generally processed and coordinated in the fail-safe SIMATIC controller. Here, the system components communicate via the PROFINET or PROFIBUS fieldbus. The safety functions are controlled via the safe PROFIsafe communication protocol.

SINAMICS drives can be easily integrated into the plant or system topology.

##### **PROFIsafe**

SINAMICS drives support the PROFIsafe profile based on PROFINET as well as on PROFIBUS.

PROFIsafe is an open communications standard that supports standard and safety-related communication over the same communication path (wired or wireless). A second, separate bus system is therefore not necessary. The telegrams that are sent are continually monitored to ensure safety-relevant communication.

Possible errors such as telegrams that have been lost, repeated or received in the incorrect sequence are avoided. This is done by consecutively numbering the telegrams in a safety-relevant fashion, monitoring their reception within a defined time and transferring an ID for transmitter and receiver of a telegram. A CRC (cyclic redundancy check) data security mechanism is also used.

##### **The operating principle of Safety Integrated**

###### Two independent switch-off signal paths

Two independent switch-off signal paths are available. All switch-off signal paths are low active. This ensures that the system is always switched to a safe state if a component fails or in the event of cable breakage. If a fault is discovered in the switch-off signal paths, the STO or SS1 function (depending on parameter settings) is activated and a system restart inhibited.

###### Two-channel monitoring structure

All the main hardware and software functions for Safety Integrated are implemented in two independent monitoring channels (e.g. switch-off signal paths, data management, data comparison). A cyclic crosswise comparison of the safety-relevant data in the two monitoring channels is carried out.

The monitoring functions in each monitoring channel work on the principle that a defined state must prevail before each action is carried out and a specific acknowledgement must be made after each action. If these expectations of a monitoring channel are not fulfilled, the drive coasts to a standstill (two channel) and an appropriate message is output.

###### Forced dormant error detection using test stop

The functions and switch-off signal paths must be tested at least once within a defined time in order to meet requirements as per EN ISO 13849-1 and IEC 61508 in terms of timely fault detection. This must be implemented either in cyclic manual mode or the test stop must be automatically initiated as part of the process. The test stop cycle is monitored, and after a specific time has been exceeded, an alarm is output. A test stop does not require a POWER ON. The acknowledgment is set by canceling the test stop request.

Examples of when forced dormant error detection must be performed:

- When the drives are at a standstill after the system has been switched on
- Before the protective door is opened
- At defined intervals (e.g. every 8 hours)
- In automatic mode, time and event-driven

<sup>1)</sup> Only applies to SINAMICS G Control Unit CU250S-2 and SINAMICS S. Available for SINAMICS G via hardware versions "-F".

## Function

### Safe speed/position sensing without/with encoder

#### Safe actual value sensing without encoder

A drive monitor with encoder is necessary for operation of a series of safety functions.

For applications with encoderless mode or with encoders that have no safety capability, the safety functions can also be implemented without encoder. It is not possible to use all safety functions in this case.

In operation without encoder, the actual speed values are calculated from the measured electrical actual values. This means that speed monitoring is also possible during operation without an encoder.

#### Safe actual value sensing with encoder

Incremental encoders or absolute encoders can be used for safe sensing of the position values on a drive.

Safe actual value sensing relies on redundant evaluation of the incremental tracks A/B that supply sin/cos signals of  $1 V_{pp}$ . Only encoders of the type whose A/B track signals are created and processed using purely analog techniques can be used.

HTL/TTL incremental encoders may also be used. In this case, safe actual value sensing is achieved by using two independent encoders. The minimum possible speed resolution must also be taken into account.

The encoder signals are input via Sensor Modules.

As an alternative, motors with an integrated DRIVE-CLiQ interface can be used. The speed or position actual values are generated directly in the motor as safe values and are transferred to the Control Unit over safe communication via DRIVE-CLiQ.

Certified built-on rotary encoders with DRIVE-CLiQ interface may also be used (see <https://support.industry.siemens.com/cs/document/65402168>).

The encoder must be mechanically attached in such a manner that the encoder shaft is unable to unplug or slide off. For notes on this, see IEC 61800-5-2: 2016, Table D.16.

A list of Siemens motors that fulfill the electrical and mechanical requirements is available at: <https://support.industry.siemens.com/cs/document/33512621>

The following can be used for safe speed/position sensing:

- Single-encoder systems or
- Dual-encoder systems

### Single-encoder system

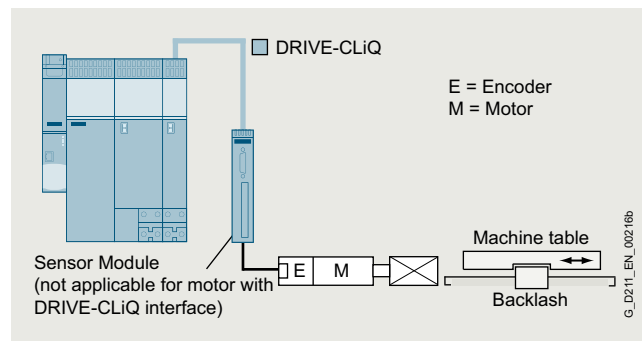

Example: Single-encoder system

In a single-encoder system, the motor encoder is used exclusively for safe actual value sensing.

### Dual-encoder system

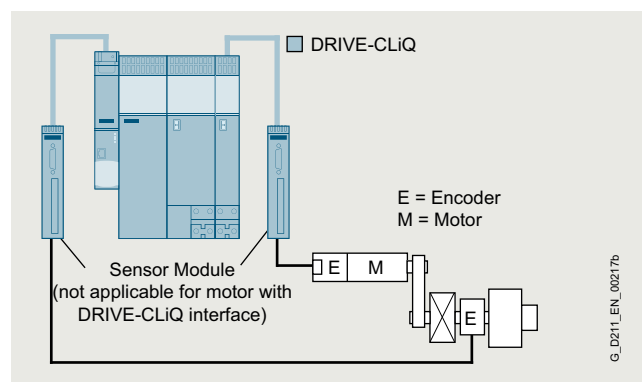

Example: Dual-encoder system

In the case of the dual-encoder system, the safe actual values for a drive are provided by two separate encoders. The actual values are transferred to the Control Unit over DRIVE-CLiQ. When motors without a DRIVE-CLiQ connection are used, a Sensor Module must be provided.

HTL/TTL incremental encoders can be used as an alternative with a dual-encoder system. Either two HTL/TTL encoders, one dual-HTL/TTL encoder or one HTL/TTL encoder and one sin/cos encoder can be used.

## Safety Integrated

### Safety Integrated

#### Function

The safety functions are listed below with criteria for actual value sensing:

	Functions	Abbreviation	With encoder	Without encoder	Description
<b>Basic Functions</b>	Safe Torque Off	STO	Yes	Yes	Safe Torque Off
	Safe Stop 1	SS1	Yes	Yes <sup>1)</sup>	Safe stopping process in accordance with stop category 1
	Safe Brake Control	SBC	Yes	Yes	Safe Brake Control
<b>Extended Functions</b>	Safe Torque Off	STO	Yes	Yes	Safe Torque Off
	Safe Stop 1	SS1	Yes	Yes <sup>1)</sup>	Safe stopping process in accordance with stop category 1
	Safe Brake Control	SBC	Yes	Yes	Safe Brake Control
	Safe Operating Stop	SOS	Yes	No	Safe monitoring of the standstill position
	Safe Stop 2	SS2	Yes	No	Safe stopping process in accordance with stop category 2
	Safely-Limited Speed	SLS	Yes	Yes <sup>1)</sup>	Safe monitoring of the maximum speed
	Safe Speed Monitor	SSM	Yes	Yes <sup>1)</sup>	Safe monitoring of the minimum speed
	Safe Direction	SDI	Yes	Yes <sup>1)</sup>	Safe monitoring of the direction of motion
	Safely-Limited Acceleration	SLA	Yes	No	Safely-Limited Acceleration
	Safe Brake Test	SBT	Yes	No	Diagnostic function for safe testing of the required holding torque of a brake
	<b>Advanced Functions</b>	Safely-Limited Position	SLP	Yes	No
Safe Position		SP	Yes	Yes <sup>2)</sup>	Safe transfer of position values
Safe Cam		SCA	Yes	No	Safe cams

<sup>1)</sup> The use of this safety function without encoder is permitted with asynchronous (induction) motors, synchronous motors from the SIEMOSYN series, or with SIMOTICS reluctance motors.

<sup>2)</sup> Only for the transmission of relative position values. An encoder is required to transmit absolute position values.

## Integration

The safety functions integrated in SINAMICS drives, including SIMATIC ET 200pro FC-2 frequency converters, are listed below.

Safety Integrated	Low voltage Standard Performance frequency converters SINAMICS						Distributed frequency converters SINAMICS			SIMATIC ET 200pro FC-2 <sup>6)</sup>
	V20	G120C	G120			G130 G150	G115D wall and motor-mounted	G120D		
			CU230P-2	CU240E-2	CU250S-2			CU240D-2	CU250D-2	
<b>Functions</b>										
STO	–	✓	–	✓	✓	✓	✓	✓	✓	✓
SS1	–	–	–	✓ <sup>1)</sup>	✓	✓	–	✓ <sup>1)</sup>	✓ <sup>1)</sup>	–
SS2	–	–	–	–	–	✓ <sup>1)</sup>	–	–	–	–
SOS	–	–	–	–	–	✓ <sup>1)</sup>	–	–	–	–
SBC	–	–	–	–	✓	✓	–	–	–	–
SBT	–	–	–	–	–	✓ <sup>1)</sup>	–	–	–	–
SLS	–	–	–	✓ <sup>1)</sup>	✓ <sup>2)</sup>	✓ <sup>1)</sup>	✓ <sup>2)</sup>	✓ <sup>1)</sup>	✓ <sup>1)</sup>	–
SSM	–	–	–	✓ <sup>1)</sup>	✓ <sup>2)</sup>	✓ <sup>1)</sup>	–	✓ <sup>1)</sup>	✓ <sup>1)</sup>	–
SDI	–	–	–	✓ <sup>1)</sup>	✓ <sup>2)</sup>	✓ <sup>1)</sup>	–	✓ <sup>1)</sup>	✓ <sup>1)</sup>	–
SLA	–	–	–	–	–	✓ <sup>1)</sup>	–	–	–	–
SLP	–	–	–	–	–	✓ <sup>3)</sup>	–	–	–	–
SP	–	–	–	–	–	✓ <sup>3)</sup>	–	–	–	–
SCA	–	–	–	–	–	✓ <sup>3)</sup>	–	–	–	–
<b>Control</b>										
PROFIsafe	–	✓	–	✓	✓	✓	✓	✓	✓	–
F-DI	–	✓	–	✓	✓	✓	✓	✓	✓	–

Safety Integrated	Low voltage Industry-specific frequency converters				Servo converters			High performance frequency converters		
	SINAMICS G120P		G120X	G180	V90	S110 CU305	S210	S210 (New)	S120 S120M CU310-2	S150 CU320-2
	CU230P-2	–								
<b>Functions</b>										
STO	–	✓ <sup>7)</sup>	✓	✓	✓	✓	✓	✓	✓	✓
SS1	–	–	–	–	✓	✓ <sup>2) 8)</sup>	✓ <sup>8) 9)</sup>	✓	✓	✓
SS2	–	–	–	–	✓ <sup>2)</sup>	✓ <sup>2)</sup>	✓ <sup>9)</sup>	✓ <sup>2)</sup>	✓ <sup>2)</sup>	✓ <sup>2)</sup>
SOS	–	–	–	–	✓ <sup>2)</sup>	✓ <sup>2)</sup>	✓ <sup>9)</sup>	✓ <sup>2)</sup>	✓ <sup>2)</sup>	✓ <sup>2)</sup>
SBC	–	–	–	–	✓	✓	✓ <sup>9)</sup>	✓	✓	✓
SBT	–	–	–	–	–	✓ <sup>2)</sup>	✓ <sup>9)</sup>	✓ <sup>2)</sup>	✓ <sup>2)</sup>	✓ <sup>2)</sup>
SLS	–	–	–	–	✓ <sup>2)</sup>	✓ <sup>2)</sup>	✓ <sup>9)</sup>	✓ <sup>2)</sup>	✓ <sup>2)</sup>	✓ <sup>2)</sup>
SSM	–	–	–	–	✓ <sup>2)</sup>	✓ <sup>2)</sup>	✓ <sup>9)</sup>	✓ <sup>2)</sup>	✓ <sup>2)</sup>	✓ <sup>2)</sup>
SDI	–	–	–	–	✓ <sup>2)</sup>	✓ <sup>2)</sup>	✓ <sup>9)</sup>	✓ <sup>2)</sup>	✓ <sup>2)</sup>	✓ <sup>2)</sup>
SLA	–	–	–	–	–	✓ <sup>2)</sup>	✓ <sup>9)</sup>	✓ <sup>2)</sup>	✓ <sup>2)</sup>	✓ <sup>2)</sup>
SLP	–	–	–	–	–	–	–	✓ <sup>3)</sup>	✓ <sup>3) 4)</sup>	✓ <sup>5)</sup>
SP	–	–	–	–	–	–	–	✓ <sup>3)</sup>	✓ <sup>3) 4)</sup>	✓ <sup>5)</sup>
SCA	–	–	–	–	–	–	–	✓ <sup>3)</sup>	✓ <sup>3) 4)</sup>	✓ <sup>5)</sup>
<b>Control</b>										
PROFIsafe	–	–	–	–	✓	✓	✓	✓	✓	✓
F-DI	–	✓	✓	✓	✓	✓	✓	✓	✓	✓

## More Information

The Safety Integrated Function Manual contains detailed information about the safety functions

<https://support.industry.siemens.com/cs/document/109781722>

Further manuals pertaining to Safety Integrated in drive systems can be found on the internet at

<https://support.industry.siemens.com/cs/ww/en/ps/13206/man>

More information about Safety Integrated in SINAMICS can be found on the internet at

[www.siemens.com/safety-drives](http://www.siemens.com/safety-drives)

- 1) With fail-safe Control Unit.
- 2) With Safety Extended license.
- 3) With Safety Advanced license.
- 4) Safety Advanced license for cabinet modules on request.
- 5) Safety Advanced license on request.
- 6) Information on the SIMATIC ET 200pro FC-2 frequency converter – depending on the SIMATIC ET 200pro station – is available at: [www.siemens.com/et200pro-fc](http://www.siemens.com/et200pro-fc)
- 7) With external safety relay.
- 8) Safe Stop 1 time controlled (SS1-t) is also included in the Safety Integrated Basic functions.
- 9) The Extended Functions require a Safety license. The functions SS1, SLS, SDI and SSM are available with firmware V6.1. Further functions will be added in a subsequent version.

## Safety Integrated

### Safety Integrated for SINAMICS G120C

#### Overview



The SINAMICS G120C frequency converter offers the Safe Torque Off (STO) function as a standard feature.

The Safety Integrated function is completely integrated into the drive system. It can be activated via fail-safe digital inputs on the converter or via PROFINET or PROFIBUS with PROFIsafe.

The Safety Integrated function is implemented electronically and therefore offers short response times in comparison to solutions with externally implemented monitoring functions.

#### Function

Function	Control	Encoder required	License required
STO	<ul style="list-style-type: none"> <li>F-DI</li> <li>PROFIsafe</li> </ul>	No	No

## Overview



The PM240-2 and PM250 Power Modules are already designed for Safety Integrated.

In conjunction with a standard Control Unit, the drive provides the safety function STO. The PM240-2 Power Modules, frame sizes FSD to FSG additionally offer STO acc. to IEC 61508 SIL 3 and EN ISO 13849-1 PL e and Category 3.

In conjunction with a fail-safe Control Unit, the drive can be turned into a Safety Integrated Drive with comprehensive safety functions.

The Safety Integrated functions are completely integrated into the drive system. They can be activated via fail-safe digital inputs or via PROFINET or PROFIBUS with PROFIsafe.

The Safety Integrated functions are implemented electronically and therefore offer short response times in comparison to solutions with externally implemented monitoring functions.

### Safety Integrated encoderless

The safety functions do not require a motor encoder; the implementation effort is minimal. Existing machines in particular can be updated with integrated safety technology without the need to change the motor or mechanical system.

The STO function can be used without any restrictions for all applications.

The SS1, SLS, SSM and SDI functions are only permissible for applications where the load can never cause acceleration. An encoder that is used for the purposes of motor control has no significance for the safety functions here.

### Safety Integrated overview

The availability of Safety Integrated functions depends on the type of Control Unit. Standard Control Units and fail-safe Control Units are available.

The CU240E-2 standard Control Units have STO and the CU250S-2 Control Units have STO, SBC, and SS1 as standard.

The fail-safe Control Units offer Extended Functions (SLS, SDI, SSM) in addition to the Basic Functions (STO, SS1). The Basic Function SBC is currently supported by the CU250S-2.

A license is required for operation of the Extended Functions on the CU250S-2 Control Unit. It is of no consequence here which Safety Integrated functions are used and how many.

The license can be ordered as an option with the memory card. Alternatively, a single-user license can also be purchased.

### Safe Brake Relay



The Safe Brake Control (SBC) function requires a Safe Brake Relay. The Safe Brake Relay allows safe control of electro-mechanical motor brakes.

The 24 V DC solenoid of the motor brake is directly connected to the Safe Brake Relay. External surge suppressors are not required. The cable harnesses for connection to the Power Module are included in the scope of supply.

With the Safe Brake Relay function, the brake is controlled in accordance with IEC 61508 SIL 2 and EN ISO 13849-1 PL d and Category 3.

# Safety Integrated

## Safety Integrated for SINAMICS G120

### Benefits

#### Comparison between conventional and integrated safety systems

The safety functions integrated into the drive can greatly reduce the effort required to implement safety concepts.

The integrated safety functions provide support when setting up tailored safety concepts. Configurations of safety concepts are given below based on the example of the SINAMICS G120.

3

#### Safe Torque Off (STO)

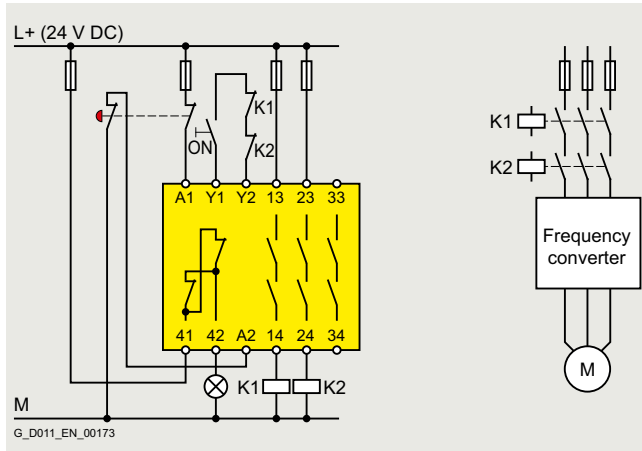

Classic implementation using an external circuit

#### Safe Stop 1 (SS1)

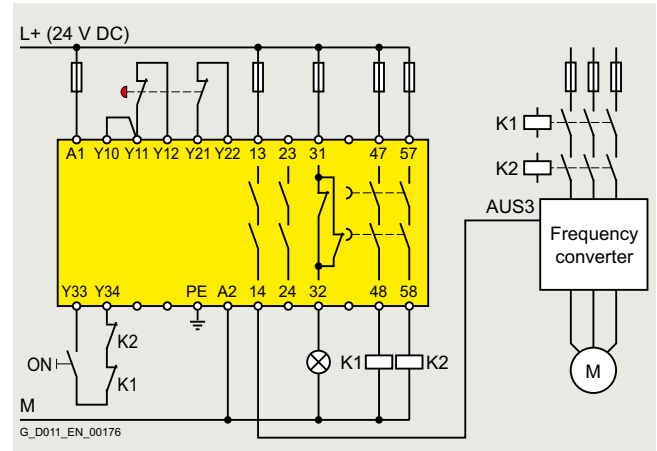

Classic implementation using an external circuit

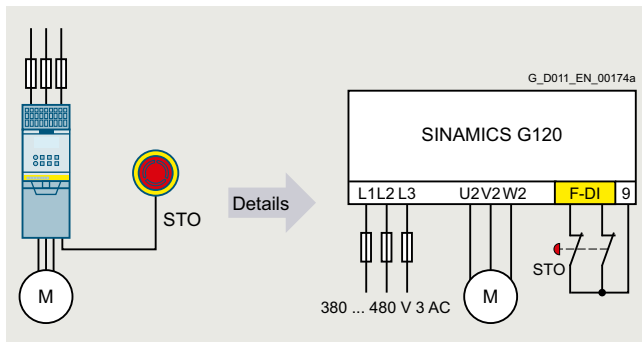

Standalone safety solution via fail-safe inputs

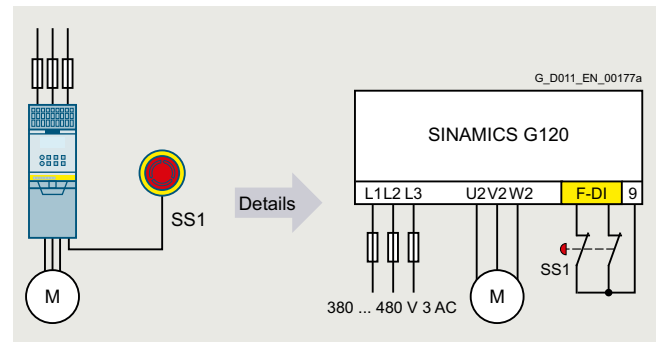

Standalone safety solution via fail-safe inputs

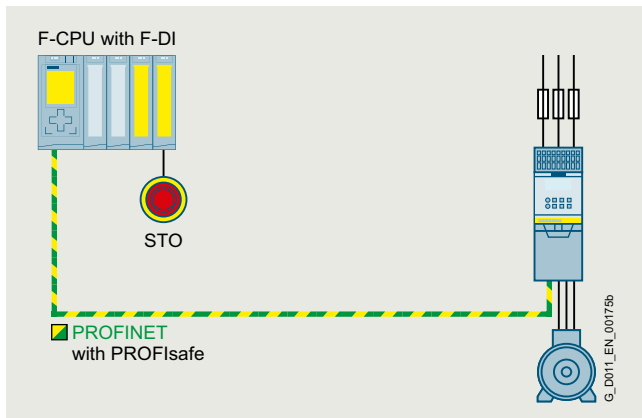

Integrated safety solution via PROFIsafe

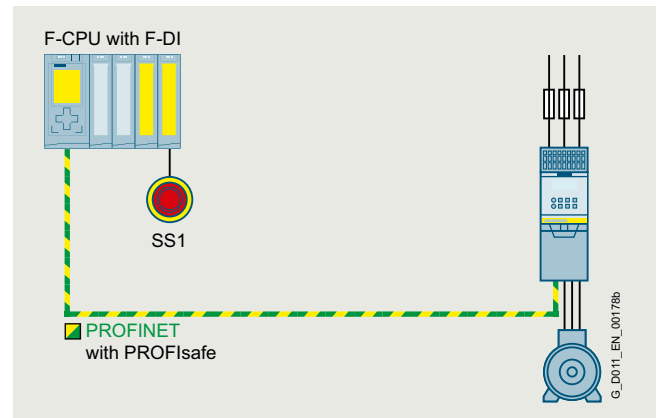

Integrated safety solution via PROFIsafe



**Benefits**

Safely-Limited Speed (SLS)

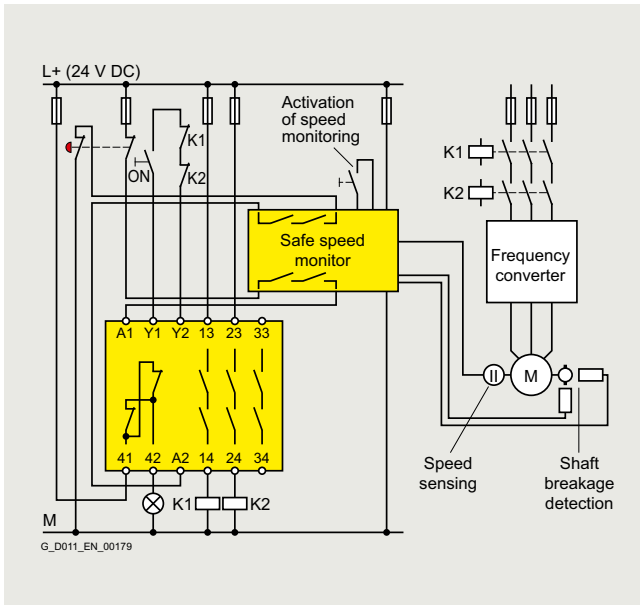

Classic implementation using an external circuit

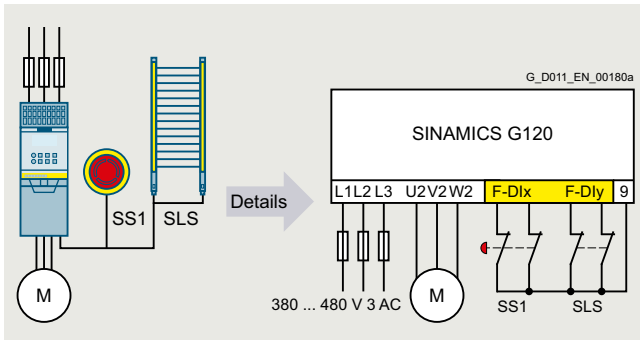

Standalone safety solution via fail-safe inputs

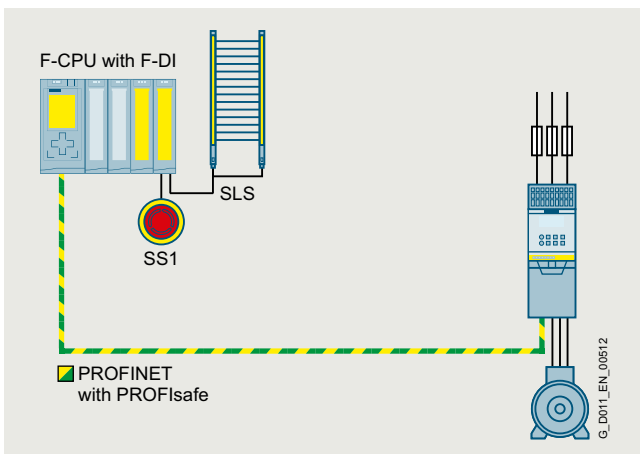

Integrated safety solution via PROFIsafe

# Safety Integrated

## Safety Integrated for SINAMICS G120

### Function

Function	Control	Underlying function	Reaction to limit overshoot	Encoder required	License required	Available in
<b>Basic Functions</b>						
<b>STO</b>	<ul style="list-style-type: none"> <li>F-DI</li> <li>PROFIsafe</li> </ul>	SBC (if activated)	–	No	No	<ul style="list-style-type: none"> <li>CU240E-2</li> <li>CU240E-2 DP</li> <li>CU240E-2 PN</li> <li>CU240E-2 F</li> <li>CU240E-2 DP-F</li> <li>CU240E-2 PN-F</li> <li>CU250S-2</li> <li>CU250S-2 CAN</li> <li>CU250S-2 DP</li> <li>CU250S-2 PN</li> </ul>
<b>SS1 time-controlled</b>	<ul style="list-style-type: none"> <li>F-DI</li> <li>PROFIsafe</li> </ul>	STO and SBC (if activated) following expiry of the parameterized delay time or if the speed falls below the minimum speed limit	STO	No	No	<ul style="list-style-type: none"> <li>CU240E-2 F</li> <li>CU240E-2 DP-F</li> <li>CU240E-2 PN-F</li> <li>CU250S-2</li> <li>CU250S-2 CAN</li> <li>CU250S-2 DP</li> <li>CU250S-2 PN</li> </ul>
<b>SBC</b>	<ul style="list-style-type: none"> <li>With STO (immediately or following expiry of the delay time with SS1)</li> </ul>	–	–	No	No	<ul style="list-style-type: none"> <li>CU250S-2</li> <li>CU250S-2 CAN</li> <li>CU250S-2 DP</li> <li>CU250S-2 PN</li> </ul>
<b>Extended Functions</b>						
<b>SS1 with SBR/SAM</b>	<ul style="list-style-type: none"> <li>F-DI</li> <li>PROFIsafe</li> </ul>	Safe Acceleration Monitor (SAM) or Safe Brake Ramp (SBR) during braking. STO and SBC (if activated) following expiry of the parameterized delay time or if the speed falls below the minimum speed limit	STO	No	No	<ul style="list-style-type: none"> <li>CU240E-2 F</li> <li>CU240E-2 DP-F</li> <li>CU240E-2 PN-F</li> </ul>
					Yes	<ul style="list-style-type: none"> <li>CU250S-2</li> <li>CU250S-2 CAN</li> <li>CU250S-2 DP</li> <li>CU250S-2 PN</li> </ul>
<b>SLS</b>	<ul style="list-style-type: none"> <li>F-DI</li> <li>PROFIsafe</li> </ul>	–	STO, SS1 (can be parameterized)	No	No	<ul style="list-style-type: none"> <li>CU240E-2 F</li> <li>CU240E-2 DP-F</li> <li>CU240E-2 PN-F</li> </ul>
					Yes	<ul style="list-style-type: none"> <li>CU250S-2</li> <li>CU250S-2 CAN</li> <li>CU250S-2 DP</li> <li>CU250S-2 PN</li> </ul>
<b>SDI</b>	<ul style="list-style-type: none"> <li>F-DI</li> <li>PROFIsafe</li> </ul>	–	STO, SS1 (can be parameterized)	No	No	<ul style="list-style-type: none"> <li>CU240E-2 F</li> <li>CU240E-2 DP-F</li> <li>CU240E-2 PN-F</li> </ul>
					Yes	<ul style="list-style-type: none"> <li>CU250S-2</li> <li>CU250S-2 CAN</li> <li>CU250S-2 DP</li> <li>CU250S-2 PN</li> </ul>
<b>SSM</b>	<ul style="list-style-type: none"> <li>Always active, if configured</li> </ul>	–	Signals that the speed has fallen below a specified value	No	No	<ul style="list-style-type: none"> <li>CU240E-2 DP-F <sup>1)</sup></li> <li>CU240E-2 PN-F <sup>1)</sup></li> </ul>
					Yes	<ul style="list-style-type: none"> <li>CU250S-2</li> <li>CU250S-2 CAN</li> <li>CU250S-2 DP</li> <li>CU250S-2 PN</li> </ul>

<sup>1)</sup> SSM is possible only with PROFIsafe.

## Overview



The integrated safety functions of SINAMICS S110 provide highly effective application-oriented protection for personnel and machinery.

SINAMICS S110 offers Extended Functions (SS2, SOS, SLS, SDI, SSM) in addition to Basic Functions (STO, SS1, SBC).

The Safety Integrated functions are implemented electronically and therefore offer short response times in comparison to solutions with externally implemented monitoring functions.

The Safety Integrated functions are completely integrated into the drive system. They can be activated via fail-safe digital inputs on the CU305 Control Unit or via PROFINET or PROFIBUS with PROFIsafe.

As an alternative to controlling via terminals and/or PROFIsafe, there is also the option to parameterize several Safety Integrated functions without selection. In this mode, after parameterization and a POWER ON, these functions are permanently selected.

Example:

"SLS without selection" can be used, for example, to monitor the maximum velocity to prevent the drive from exceeding a mechanical speed limit. For this purpose, using the "without selection" function, an F-DI does not have to be used; an F-CPU is also not required.

### Safe speed/position sensing

Incremental encoders or absolute encoders can be used for safe sensing of the position values on a drive. Safe actual value sensing relies on redundant evaluation of the incremental tracks A/B that supply sin/cos signals of  $1 V_{pp}$ . Only encoders of the type whose A/B track signals are created and processed using purely analog techniques can be used.

The encoder signals can be input via the Sensor Modules. As an alternative, motors with an integrated DRIVE-CLiQ interface can be used. The speed or position actual values are generated directly in the motor as safe values and are transferred to the Control Unit over safe communication via DRIVE-CLiQ.

The encoder must be mechanically attached in such a manner that the encoder shaft is unable to unplug or slide off. For notes on this, see IEC 61800-5-2: 2016, Table D.16.

A list of Siemens motors that fulfill the electrical and mechanical requirements is available at:

<https://support.industry.siemens.com/cs/document/33512621>

Motors with DRIVE-CLiQ interface are connected directly to the CU305 Control Unit. A SINAMICS Sensor Module is required to evaluate the encoder signals of motors without a DRIVE-CLiQ interface.

### Safe actual value sensing without encoder

Some safety functions can also be operated without safety-capable encoders; implementation effort is minimal. Existing systems in particular can be updated with safety technology without the need to change the motor or mechanical system.

The STO function can be used without any restrictions for all applications.

The SS1, SLS, SSM and SDI functions are permissible for applications in conjunction with asynchronous and SIEMOSYN motors where the load can never cause acceleration. An encoder that is used for the purposes of motor control has no significance for the safety functions here.

### Licensing

No license is required for the Basic Functions.

The Extended Functions do require a license. It is of no consequence here which Safety Integrated functions are used and how many. The license can be ordered as an option with the memory card. Alternatively, a single-user license can also be purchased.

### Safe Brake Relay



The Safe Brake Control (SBC) function requires a Safe Brake Relay. The Safe Brake Relay allows safe control of electro-mechanical motor brakes.

The 24 V DC solenoid of the motor brake is directly connected to the Safe Brake Relay. External surge suppressors are not required. The cable harnesses for connection to the Power Module are included in the scope of supply.

With the Safe Brake Relay function, the brake is controlled in accordance with IEC 61508 SIL 2 and EN ISO 13849-1 PL d and Category 3.

# Safety Integrated

## Safety Integrated for SINAMICS S110

### Function

Function	Control	Underlying function	Reaction to limit overshoot	Encoder required	License required
<b>Basic Functions</b>					
<b>STO</b>	<ul style="list-style-type: none"> <li>F-DI</li> <li>PROFIsafe</li> </ul>	SBC (if activated)	–	No	No
<b>SS1 time-controlled</b>	<ul style="list-style-type: none"> <li>F-DI</li> <li>PROFIsafe</li> </ul>	STO and SBC (if activated) following expiry of the parameterized delay time or if the speed falls below the minimum speed limit	STO	No	No
<b>SBC</b>	<ul style="list-style-type: none"> <li>With STO (immediately or following expiry of the delay time with SS1)</li> </ul>	–	–	No	No
<b>Extended Functions</b>					
<b>SS1 with SBR/SAM</b>	<ul style="list-style-type: none"> <li>F-DI</li> <li>PROFIsafe</li> </ul>	Safe Acceleration Monitor (SAM) or Safe Brake Ramp (SBR) during braking. STO and SBC (if activated) following expiry of the parameterized delay time or if the speed falls below the minimum speed limit.	STO	No	Yes
<b>SS2</b>	<ul style="list-style-type: none"> <li>F-DI</li> <li>PROFIsafe</li> </ul>	Safe acceleration monitoring (SBR – Safe Brake Ramp) during braking. SOS following expiry of the parameterized delay time	SS1 → STO	Yes	Yes
<b>SOS</b>	<ul style="list-style-type: none"> <li>F-DI</li> <li>PROFIsafe</li> </ul>	–	SS1 → STO	Yes	Yes
<b>SLS</b>	<ul style="list-style-type: none"> <li>F-DI</li> <li>PROFIsafe</li> </ul>	–	STO, SS1, SS2 or SOS (can be parameterized)	Yes	Yes
<b>SLS encoderless</b>	<ul style="list-style-type: none"> <li>F-DI</li> <li>PROFIsafe</li> </ul>	–	STO, SS1 (can be parameterized)	No	Yes
<b>SDI</b>	<ul style="list-style-type: none"> <li>F-DI</li> <li>PROFIsafe</li> </ul>	–	STO, SS1, SS2 or SOS (can be parameterized)	No	Yes
<b>SSM</b>	<ul style="list-style-type: none"> <li>Always active, if configured</li> </ul>	–	Signals that the speed has fallen below a specified value	No	Yes

3

## Energy efficiency



4/2 4/2	<b>Energy efficiency</b> Success factor Energy Efficiency
4/3	<b>SIMATIC Energy Suite – integrated energy management</b>
4/4 4/5	<b>Energy-efficient drives</b> Overview of the energy-saving functions for SINAMICS drives
4/7	<b>Energy efficiency classes in accordance with IEC 61800-9-2</b>

Further information about energy efficiency including references from industrial production can be found at [www.siemens.com/energy-efficiency](http://www.siemens.com/energy-efficiency) [www.siemens.com/energysaving](http://www.siemens.com/energysaving)

## Energy efficiency

### Energy efficiency

#### Overview

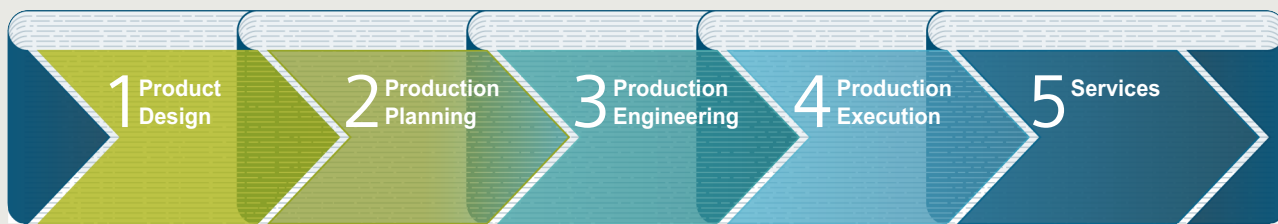

G\_D011\_EN\_00555

4

#### **Success factor Energy Efficiency**

Siemens helps you to optimize your energy demand, reduce your energy costs and increase your competitive advantage

Industry is facing enormous challenges: Production processes need to be highly productive, energy-efficient, and resource-saving. Siemens is offering an energy efficiency concept that continually and systematically reduces the power consumption of machines and equipment and thereby boosts the competitive advantage of industrial producers. When implementing energy-efficient solutions, Siemens not only assesses the production process as a whole, but also evaluates each individual production step.

##### **1 Produkt Design**

Improve your confidence in planning outcomes! It is important to know the costs associated with the operation of a production machine so that these can be taken into account in the machine design. For example, the SinaSave software application can help you to calculate how soon you will recoup your investment if you purchase an energy-efficient drive. The Mechatronic Support simulation package will also provide you with the means to test and optimize your machine concept, Helping you to save time, energy and operating expenses. See also the SIZER for Siemens Drives engineering tool.

SinaSave: [www.siemens.com/sinasave](http://www.siemens.com/sinasave)

SIZER for Siemens Drives (integrated in the TIA Selection Tool): [www.siemens.com/sizer](http://www.siemens.com/sizer)

##### **2 Production Planning**

Make your plant more profitable! It is possible to carry out an on-screen simulation of individual machines and even the entire production process. By doing this, you can optimize the efficiency and productivity of production processes. For example, you can use the digital models and analysis functions provided by the Plant Simulation tool in order to optimize the motion sequences of your machines, prevent load peak overlaps, recover energy and optimize speeds.

Plant Simulation: [www.siemens.com/tecnomatix](http://www.siemens.com/tecnomatix)

##### **3 Production Engineering**

Optimize the workflow! The SIMATIC Energy Manager PRO management tool helps you to achieve efficient control of energy and costs. But this requires perfectly coordinated communication and operation between hardware and software. Using the TIA Portal engineering framework, for example, it is easy to set up and optimize every single engineering process. You can then see at a glance the areas in your plant that can be made more productive and environmentally friendly. See also the STARTER commissioning tool and the SINAMICS Startdrive commissioning tool.

SIMATIC Energy Manager PRO:

[www.siemens.com/energymanagerpro](http://www.siemens.com/energymanagerpro)

TIA Portal: [www.siemens.com/tia-portal](http://www.siemens.com/tia-portal)

STARTER: [www.siemens.com/starter](http://www.siemens.com/starter)

SINAMICS Startdrive: [www.siemens.com/startdrive](http://www.siemens.com/startdrive)

##### **4 Production Execution**

Use innovative drive technology to reduce your energy consumption! The energy-efficient components and systems developed by Siemens can cut the energy consumption of a plant. Important components in an energy-efficient plant are, for example, frequency converters with regenerative feedback functions for applications with variable speeds or soft starters for fixed-speed drives. With its PROFenergy system, Siemens is also offering solutions that permit centralized shutdown of loads or entire production units during production breaks – a vendor- and device-neutral interface for flexible use over short or long production breaks.

##### **5 Services**

Improve your productivity and efficiency while reducing total costs! With its Energy & Environmental Services, Siemens is offering a tailored consultancy that will provide you with the necessary support in designing and implementing systematic energy and environmental management solutions. It will give you the satisfaction of achieving maximum energy efficiency throughout your company.

#### **More information**

Further information about energy efficiency including references from industrial production can be found at

[www.siemens.com/energy-efficiency](http://www.siemens.com/energy-efficiency)

[www.siemens.com/energysaving](http://www.siemens.com/energysaving)

## Overview

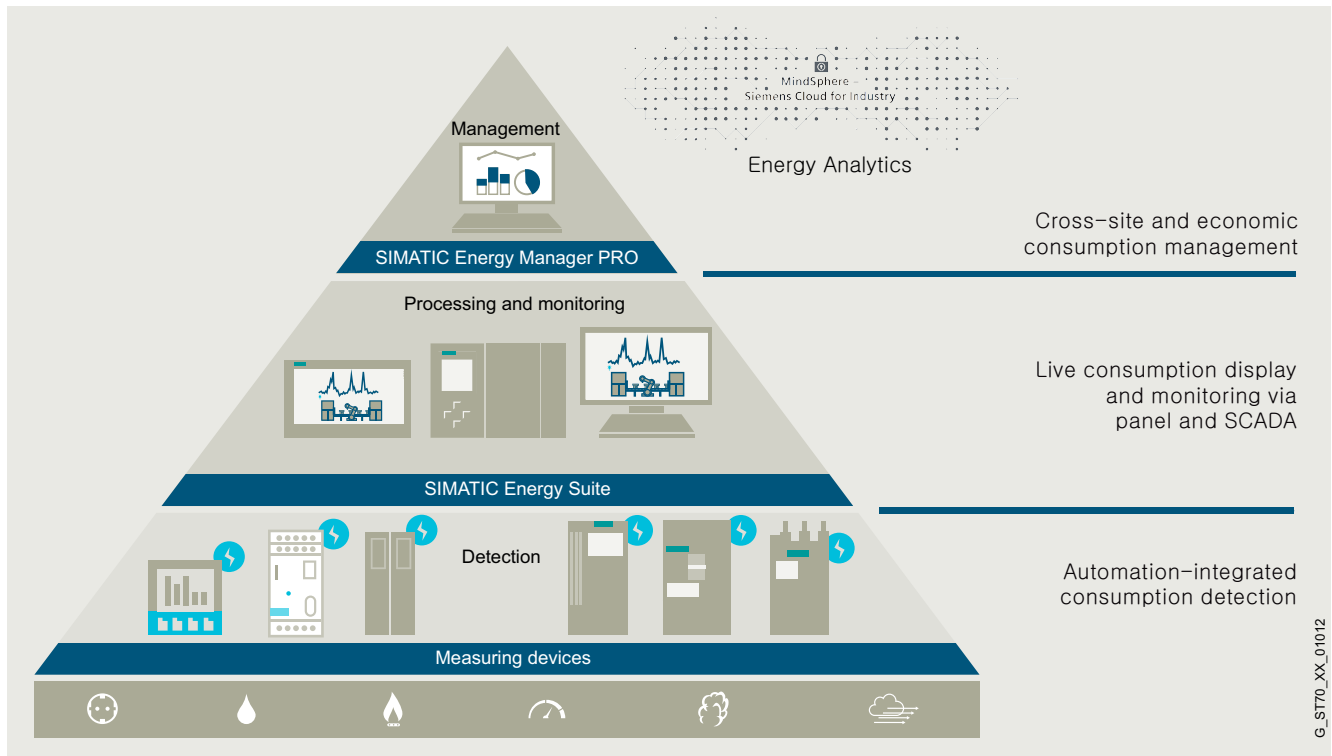

G\_ST70\_XX\_01012

A high energy consumption and automated production are typical for many industries.

If you want to keep your energy costs under control in the long term and you are already focusing on the digital future, you will equip your plant with integrated energy measuring technology, thus anchoring your energy management in the automation of your production processes – which is where most energy is consumed. SIMATIC Energy Suite as an integrated option for the TIA Portal efficiently links energy management with automation, thus creating energy transparency in production. The considerably simplified configuration of energy measuring components from the product families<sup>2)</sup> SIMATIC, SENTRON, SINAMICS, SIRIUS and SIMOCODE significantly reduces the configuration costs. Thanks to the end-to-end connection to SIMATIC Energy Manager PRO<sup>1)</sup> or cloud-based Service Energy Analytics, you can seamlessly expand the recorded energy data to create a cross-site energy management system.

This additionally enables companies to satisfy all the required economic and energy management aspects – from the purchasing of energy and planning all the way to energy controlling.

The advantages at a glance:

- Automatic generation of energy management data
- Integration into TIA Portal and into automation
- Simple configuration

**Highlights**

- Simple and intuitive configuration instead of programming
- Automatic generation of the PLC energy program
- Convenient integration of measuring components from the Siemens portfolio and from the portfolio of other vendors
- Integrated into the TIA Portal and automation
- Archiving on WinCC Professional or PLC
- Seamless connection to Energy Manager PRO and Energy Analytics

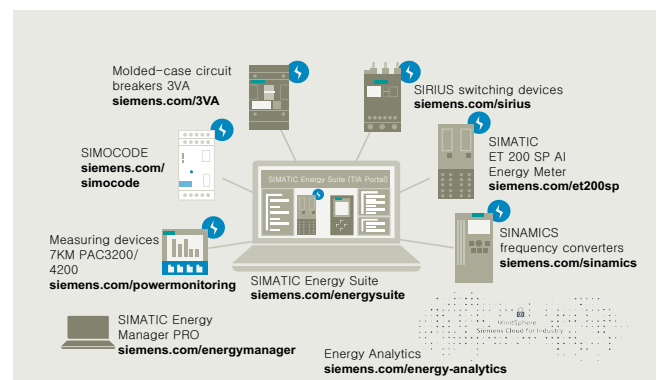

Ready for  
SIMATIC  
Energy Suite

Further information on  
SIMATIC Energy Suite:  
[www.siemens.com/energysuite](http://www.siemens.com/energysuite)

<sup>1)</sup> SIMATIC Energy Manager PRO is the innovative successor to SIMATIC B.Data

<sup>2)</sup> Products of the SIMATIC, SENTRON, SINAMICS, SIRIUS and SIMOCODE product families. You can find details on the currently supported devices here:  
[www.siemens.com/energysuite-hardware](http://www.siemens.com/energysuite-hardware)

## Energy efficiency

### Energy-efficient drives

#### Overview

#### **Energy-efficient SINAMICS drives save energy in an intelligent way**

Exploit energy-saving potential and optimize energy consumption: You can - with intelligent SINAMICS drives. Depending on the application in question, energy consumption can be controlled by motor speed adjustment to suit the individual process and achieve the greatest possible energy savings. The energy consumption of drives for turbo machines can be cut by as much as 60 %. Regenerative feedback is also an option for many applications. Our portfolio of frequency converters is the most comprehensive and standardized range on the market and the first choice for anyone seeking an energy-efficient drive – at low-voltage or medium-voltage level.

#### **Energy-efficient drives with intelligent functions**

Depending on the application and load profile, the intelligent energy-saving functions of SINAMICS drives can cut energy consumption.

#### PROFenergy



Provides energy-related status data for the system components to create transparency for the energy management; energy savings by selective shut-down of plants or plant sections.

#### ECO-Modus



In ECO mode, the operating point of the motor in the partial-load range is automatically adjusted and optimized. This reduces motor losses, for example, in machines that do not need a high torque over the entire operating range.

#### Hibernation mode



Variable-speed drives that are not required to operate continuously are switched to standby or "Hibernation mode". The drive is restarted again as soon as it is needed.

#### Bypass mode

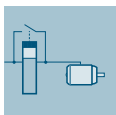

In bypass mode it is possible to "bypass" the converter electrically as soon as the motor is frequently operating close to its rated speed. This solution helps reduce converter losses and so increase overall efficiency.

#### Cascading

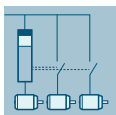

In pump, fan and compressor applications involving high outputs, the entire power demand is distributed among several motors. Phased connection and disconnection by means of partially or fully controlled cascades in combination with converters make a drive system more energy-efficient.

#### Energy balancing

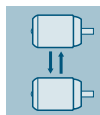

Through the use of converters with coupled drives, energy is exchanged through the common DC link. Through the direct energy exchange from one converter to the next, it is possible to minimize power losses in the system.

#### Reactive power compensation

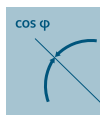

The use of SINAMICS converters with Active Line Modules reduces the capacitive and/or inductive reactive power in the machine. It is then possible to dispense with costly reactive power compensation systems.

#### Kinetic energy buffering



With dynamic reversing operations in single-axis and multi-axis systems, the kinetic energy available in the system is reused. A motor connected to the common DC link is used to buffer kinetic energy.

#### Electrical energy buffering



With dynamic reversing operations in single-axis and multi-axis systems, the kinetic energy available in the system is reused. A capacitor module connected to the common DC link is used to buffer electrical energy.

#### Optimized pulse patterns

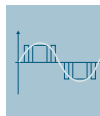

Thanks to optimized clock frequency and pulse pattern, SINAMICS G and SINAMICS S are perfectly suited to SIMOTICS motors and SIMOGEAR geared motors. The benefits: Optimization of performance and system efficiency, reduced system losses as well as lower temperature and noise levels.

#### Energy usage counter/Energy saving counter



Actual energy usage can be displayed during operation. Furthermore, an energy saving counter can be installed to indicate the cumulative energy savings during machine operation as compared to a fixed-speed application.

#### Regenerative feedback

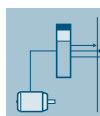

In conventional drive systems, the energy produced during braking is converted to heat using braking resistors. SINAMICS G and SINAMICS S converters with regenerative feedback capability need no braking resistor, and supply the resulting braking energy back into the line.

#### DC link coupling with SINAMICS V20

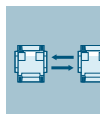

Applications with two SINAMICS V20 converters with the same power rating can share a common DC link in order to reuse regenerated energy.



## Integration

## Overview of the energy-saving functions for SINAMICS drives including SIMATIC ET 200pro FC-2 frequency converters

Energy-saving function	Low voltage									
	Standard Performance frequency converters						Distributed frequency converters			
	SINAMICS						SINAMICS		SIMATIC	
V20	G120C	G120			G130 G150	G115D wall and motor- mounted	G120D		ET 200pro FC-2 <sup>1)</sup>	
		CU230P-2	CU240E-2	CU250S-2	CU320-2		CU240D-2	CU250D-2		
<b>Functions</b>										
ECO mode	✓	✓	✓	✓	✓	–	✓	✓	✓	✓
Hibernation mode	✓	–	✓	–	–	–	–	–	–	–
Bypass mode	–	–	✓	–	–	✓	–	–	–	–
Cascading	✓	–	✓	–	–	–	–	–	–	–
Energy balancing	✓	–	–	–	–	–	–	–	–	–
Reactive power compensation	–	–	–	–	–	–	–	–	–	–
Kinetic energy buffering	–	–	–	–	–	–	–	–	–	–
Electrical energy buffering	–	–	–	–	–	–	–	–	–	–
Optimized pulse patterns	–	–	–	–	–	✓	–	–	–	–
Energy usage counter/Energy saving counter	✓	✓	✓	✓	✓	✓	✓	✓	✓	✓
Regenerative feedback	–	–	✓ with PM250 Power Module	✓ with PM250 Power Module	✓ with PM250 Power Module	–	–	✓	✓	✓
<b>Communication protocol and profile</b>										
PROFINET	–	✓	✓	✓	✓	✓	✓	✓	✓	✓
• PROFINET energy	–	✓	✓	✓	✓	✓	✓	✓	✓	✓
<b>Ready for SIMATIC Energy Suite</b>										
Integrated energy management	–	✓	✓	✓	✓	–	✓	✓	✓	–

<sup>1)</sup> Information on the SIMATIC ET 200pro FC-2 frequency converter – depending on the SIMATIC ET 200pro station – is available at: [www.siemens.com/et200pro-fc](http://www.siemens.com/et200pro-fc)

## Energy efficiency

### Energy-efficient drives

#### Integration

Energy-saving function	Low voltage								
	Industry-specific frequency converters			Servo converters			High performance frequency converters		
	SINAMICS								
	G120P	G120X	G180	V90	S110	S210	S120 S120M	CU320-2	S150
	CU230P-2				CU305		CU310-2	CU320-2	CU320-2
<b>Functions</b>									
ECO mode	✓	✓	–	–	✓	–	✓	✓	–
Hibernation mode	✓	✓	–	–	–	–	–	–	–
Bypass mode	✓	✓	✓	–	–	–	✓	✓	✓
Cascading	✓	✓	–	–	–	–	–	–	–
Energy balancing	–	–	–	–	–	–	✓ for multi-axis drives only	✓ for multi-axis drives only	–
Reactive power compensation	–	–	–	–	–	–	✓ with Active Line Module	✓ with Active Line Module	✓
Kinetic energy buffering	–	–	✓	–	–	–	✓ for multi-axis drives only	✓ for multi-axis drives only	–
Electrical energy buffering	–	–	–	–	–	–	✓ for multi-axis drives only	✓ for multi-axis drives only	–
Optimized pulse patterns	–	–	–	–	–	–	✓	✓	✓
Energy usage counter/Energy saving counter	✓	✓	–	–	–	–	✓	✓	✓
Regenerative feedback	–	–	–	–	–	–	✓ with Smart Line Module or Active Line Module	✓ with Smart Line Module or Active Line Module	✓
<b>Communication protocol and profile</b>									
PROFINET	✓	✓	✓	–	✓	–	✓	✓	✓
• PROFINET energy	✓	✓	–	–	–	–	✓	✓	✓
<b>Ready for SIMATIC Energy Suite</b>									
Integrated energy management	✓	✓	–	–	–	–	✓	–	–

#### More information

Information on the SIMATIC ET 200pro FC-2 frequency converter with PROFINET or PROFIBUS DP - depending on the SIMATIC ET 200pro station - is available at [www.siemens.com/et200pro-fc](http://www.siemens.com/et200pro-fc)

## Overview

### Step by step to more efficiency

One of the core objectives of the European Union is a sustainable power industry. In industrial plants today, around 70 % of the power demand is from electrically driven systems. This high percentage contains huge potential for saving energy in electrical drives. For that reason, the European Union introduced minimum requirements for the energy efficiency of electric motors in the form of a statutory motor regulation as early as 2011.

These activities are extended by the 2019/1781 EU regulation dealing with stricter requirements for DOL (Direct On Line) motors and defining efficiency limits for frequency converters. The regulation provides a legal basis for technical content regarding the efficiency of specific products and services. Standardization, however, has played a leading role in determining the field and the available market technology.

Energy efficiency improvement is supported through a systematic selection of the most efficient converter and drive system technology via the IEC 61800-9 series of standards. Part 1 specifies the methodology to determine the energy efficiency index of an application based on the extended product approach (EPA) and semi analytical models (SAMs), while Part 2 provides indicators for assessing the energy efficiency performance and the classification of converters and drive systems. To take account of the different use cases, consideration of eight application-relevant operating points has been introduced as mandatory for the first time. Determination of loss values at these eight points and definition of efficiency classes are laid down by the standard in a uniform way. This enables data relevant to operation, such as application-specific load profiles, to now be taken into account more easily in the energy efficiency analysis.

The standard is especially important for variable-speed drives of the following types:

- for AC/AC converters without energy recovery functionality
- for motors with integrated converters
- for supply voltages of 100 V to 1000 V
- for power ratings of 0.12 kW to 1000 kW

To cover all applications of driven machines, the IEC 61800-9-2 standard defines operating points in full-load and partial-load operation, at which the losses of the motor and drive systems have to be determined. Based on the loss data at the operating points in partial-load operation, variable-speed drives can be explicitly considered in more detail. This makes their advantages especially clear.

#### Centrifugal pumps, fans

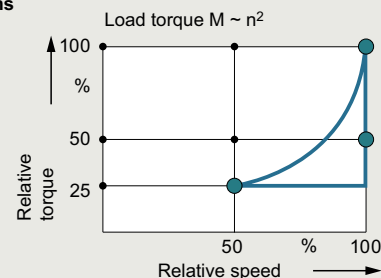

#### Hoisting gear, extruders, conveyor belts

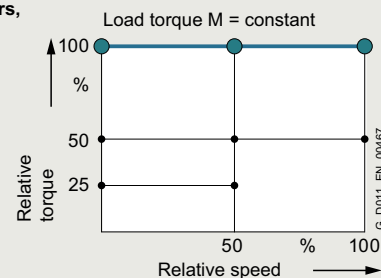

#### Winders, coilers

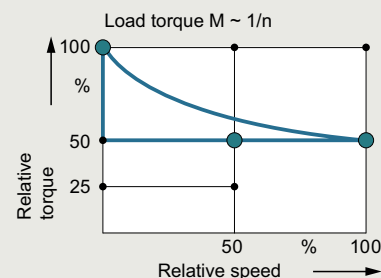

Duty cycles for different driven machines

Moreover, frequency converters and motor systems are classified in efficiency classes, which permit an initial rough estimate of the potential saving. Definition of reference systems is a key aspect of this because they provide standard reference values. The positioning of these reference systems defines the efficiency class. The relative distance from the reference system can be used as an absolute measure of the efficiency at the operating point in question.

## Energy efficiency

### Energy efficiency classes in accordance with IEC 61800-9-2

#### Overview

#### Advantages of the detailed loss consideration of IEC 61800-9-2 over the previous consideration of efficiencies and maximum loss values

For motors, the efficiency consideration was previously only defined for operation without a converter at 50/60 Hz. It provides a good way of comparing the energy efficiency of motors from different manufacturers for this use case.

The more detailed loss analysis of IEC 61800-9-2, on the other hand, is aimed at speed-controlled operation and therefore now also includes motors especially designed for converter operation in the energy analysis. These were previously not covered by the applicable standards.

Moreover, a loss analysis over the entire setting and load range of the motor is possible. This is done in accordance with the standard IEC 61800-9-2 with typical values.

For holistic consideration, it is essential to include all the relevant components of a drive system. The IEC 61800-9-2 standard defines this in detail. The standardized expression of power loss data as a percentage makes comparison considerably easier and more transparent.

The method also makes it possible to consider a motor that produces a holding torque at speed zero, for example. In this case, the efficiency is zero, but a power loss from current producing magnetization and holding torque does occur. In summary, the key advantage of standard IEC 61800-9-2 is the ability to perform the energy analysis of an electrical drive system based on standardized load profiles in all operating ranges due to uniform general conditions. This provides the user with complete transparency irrespective of the manufacturer.

#### Establishing efficiency classes of frequency converters (Complete Drive Modules CDM)

To avoid overmodulation and to ensure comparability between makes, which cannot be achieved otherwise, the efficiency classes of CDMs refer to the 90/100 operating point (90 % motor stator frequency, 100 % torque current).

Standard IEC 61800-9-2 defines the relative losses of a CDM in efficiency classes IE0 to IE2. With reference to the value of a CDM of efficiency class IE1 (reference converter), a CDM of efficiency class IE2 has 25 % lower losses and a CDM of efficiency class IE0 has 25 % higher losses.

The publication of the 2019/1781 EU regulation has made mandatory the fulfillment of the ecodesign requirements for the declaration of product conformity.

AC/AC converters belonging to the aforementioned categories (specific voltage and power level without regenerative capability) have to fulfill efficiency class IE2 in order to be approved for installation/utilization within EU.

#### Operating points for CDMs

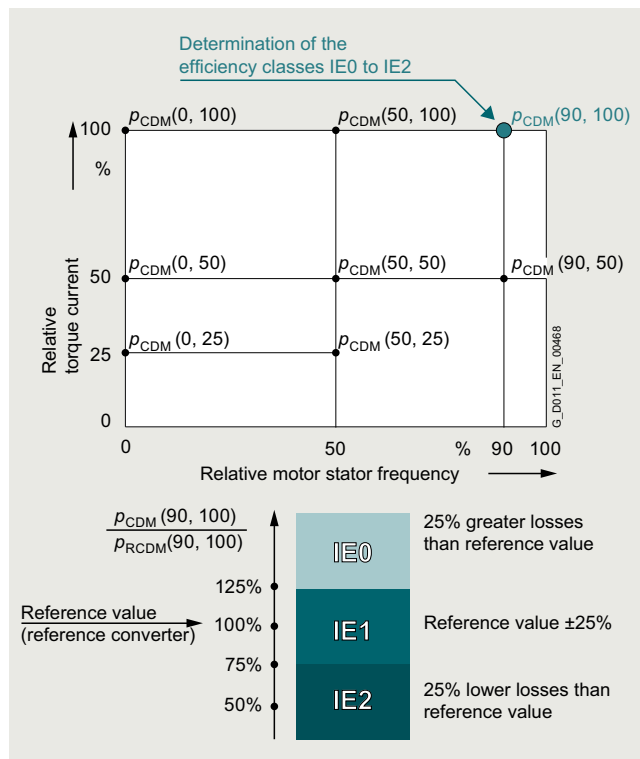

Complete Drive Module (CDM) – determining the efficiency class

#### Establishing the efficiency classes of drive systems (Power Drive Systems PDS)

What is possible for the individual systems, of course, also applies to the entire electrical PDS (frequency converter plus motor). Detailed comparisons are now possible at this level, too. The reference values for the reference system provide clear indications of the energy performance of the PDS.

Because targeted matching of the motor and CDM provides additional potential for optimization in electrical drive systems, it is especially important for the user to consider the entire drive system.

For the efficiency class of a PDS, too, a specific load point is defined. In this case, the reference point used is the 100/100 operating point (100 % motor stator frequency, 100 % torque).

Standard IEC 61800-9-2 defines the relative losses of a PDS in efficiency classes IES0 to IES2. With reference to the value of a PDS of efficiency class IES1 (reference drive), a PDS of efficiency class IES2 has 20 % lower losses and a PDS of efficiency class IES0 has 20 % higher losses.

Overview

Operating points for PDS

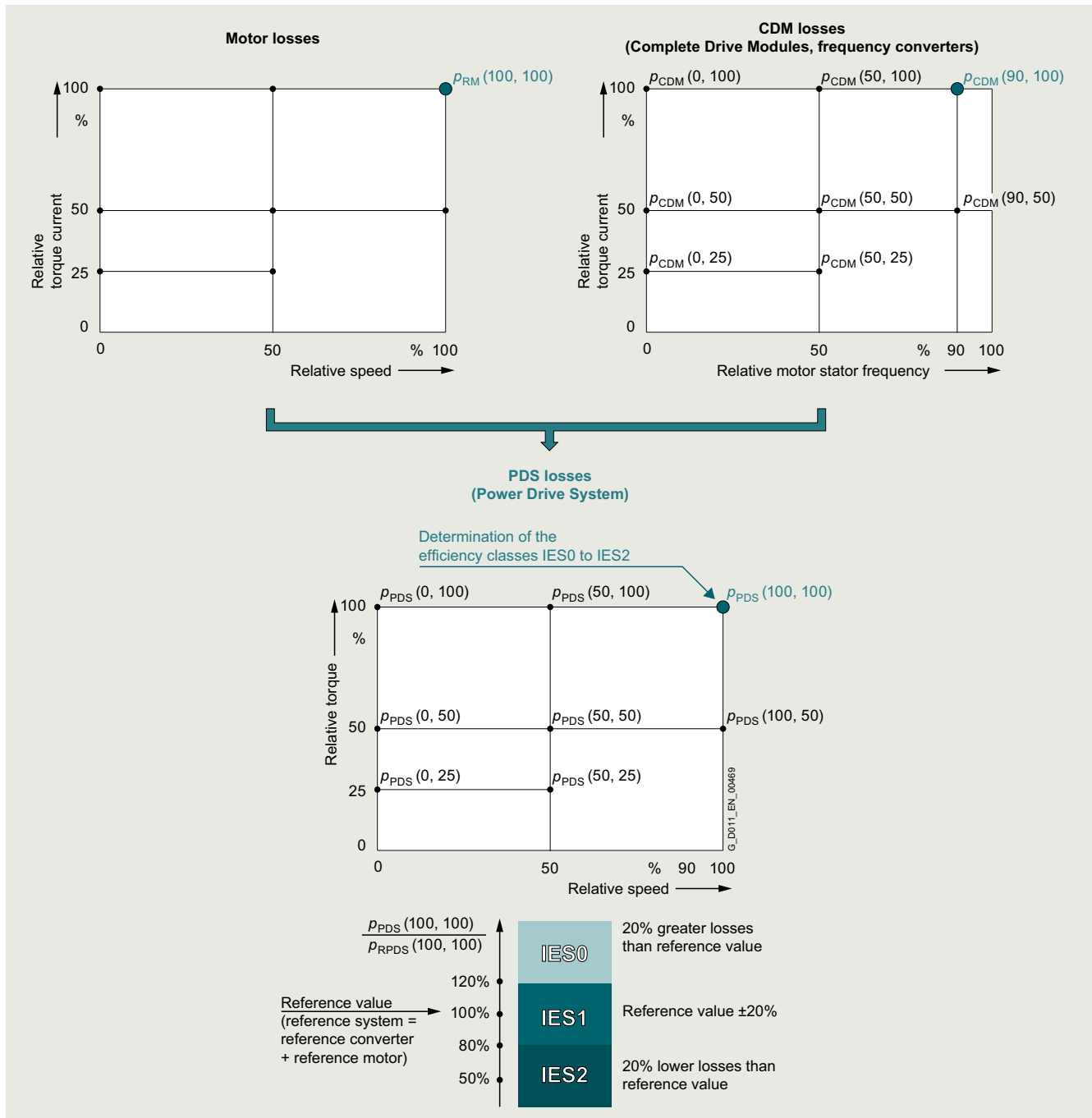

Power Drive System (PDS) – determining the efficiency class

More information

An example of a highly efficient drive system with efficiency class IES2 is the new synchronous inductance drive system with SIMOTICS reluctance motors and SINAMICS drives. More information is available on the internet at [www.siemens.com/drivesystem-reluctance](http://www.siemens.com/drivesystem-reluctance), [www.siemens.com/simotics-gp](http://www.siemens.com/simotics-gp), [www.siemens.com/simotics-sd](http://www.siemens.com/simotics-sd)

Power loss data of SINAMICS converters for single-axis drives are available on the internet at <https://support.industry.siemens.com/cs/document/94059311>. More information on current laws and standards, new standards, and mandatory guidelines is available on the internet at [www.siemens.com/legislation-and-standards](http://www.siemens.com/legislation-and-standards)

## Energy efficiency

### Notes

4

## Communication

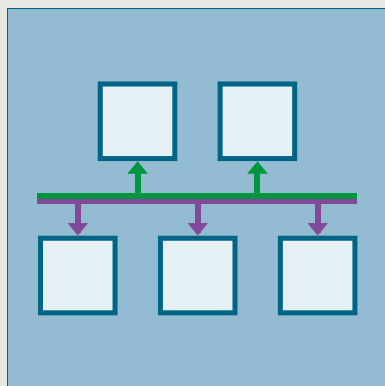

5/2 **Communication**  
5/2 Communication overview

5/4 **PROFINET**

5/8 **PROFIdrive**

5/9 **PROFIBUS**

5/10 **Industrial Ethernet**

5/11 **EtherNet/IP**

5/11 **Modbus RTU**

5/11 **BACnet MS/TP**

5/11 **CANopen**

5/12 **USS**

5/12 **FLN P1**

Further information regarding PROFINET and PROFIBUS can be found at [www.profibus.com](http://www.profibus.com)

# Communication

## Communication

### Overview

#### Communication overview

Digital bus systems are commonly used in industrial automation today. These handle communication between the control level, the machine control, the sensors and actuators. The SINAMICS product family offers integrated communication interfaces in all product groups – which can be used to connect the most important fieldbus systems in the simplest possible way.

The properties and special application areas of the various bus systems for SINAMICS converters incl. SIMATIC ET 200pro FC-2 frequency converters are briefly described in the following.

Protocol	Low voltage										
	Standard performance frequency converters						Distributed frequency converters				
	SINAMICS						SINAMICS				SIMATIC ET 200pro FC-2 <sup>1)</sup>
	V20	G120C	G120			G130 G150	G115D	G120D			
		CU230P-2	CU240E-2	CU250S-2	CU320-2		CU240D-2	CU250D-2			
<b>PROFINET</b>	–	✓	✓	✓	✓	✓	✓	✓	✓	✓	
- PROFINET RT	–	✓	✓	✓	✓	✓	✓	✓	✓	✓	
- PROFINET IRT isochronous	–	–	–	–	–	–	–	–	–	–	
- PROFINET IRT not isochronous	–	✓	✓	✓	✓	✓	✓	✓	✓	✓	
- PROFINET Shared Device	–	✓	✓	✓	✓	✓	–	✓	✓	✓	
- PROFINET media redundancy MRP (step-change)	–	✓	✓	✓	✓	✓	✓	✓	✓	✓	
- PROFINET media redundancy MRPD (bumpless)	–	✓	✓	✓	✓	✓	✓	✓	✓	–	
- System redundancy S2	–	–	–	–	–	✓	–	–	–	–	
- PROFSafe	–	✓	–	✓	✓	✓	✓	✓	✓	✓	
- PROFInergy	–	✓	✓	✓	✓	✓	✓	✓	✓	✓	
- PROFIdrive application class 1	–	✓	✓	✓	✓	✓	✓	✓	–	✓	
- PROFIdrive application class 3	–	–	–	–	✓	–	–	–	✓	–	
- PROFIdrive application class 4	–	–	–	–	–	–	–	–	–	–	
<b>PROFIBUS DP</b>	–	✓	✓	✓	✓	✓	–	✓	✓	✓	
- PROFIBUS DP equidistance and isochronous mode	–	–	–	–	–	–	–	–	–	–	
- PROFIBUS DP peer-to-peer communication	–	✓	✓	✓	✓	✓	–	✓	✓	–	
<b>EtherNet/IP</b>	–	✓	✓	✓	✓	✓	✓	✓	✓	–	
<b>Modbus TCP</b>	–	–	–	–	–	✓	–	–	–	–	
<b>Modbus RTU</b>	✓	✓	✓	✓	✓	–	–	–	–	–	
<b>AS-Interface</b>	–	–	–	–	–	–	✓	–	–	–	
<b>BACnet MS/TP</b>	–	–	✓	–	–	–	–	–	–	–	
<b>CANopen</b>	–	–	–	–	✓	–	–	–	–	–	
<b>USS</b>	✓	✓	✓	✓	✓	✓	–	–	–	–	
<b>FLN P1</b>	–	–	✓	–	–	–	–	–	–	–	
<b>Web server</b>	✓ <sup>2)</sup>	✓ <sup>2)</sup>	✓ <sup>2)</sup>	✓ <sup>2)</sup>	✓ <sup>2)</sup>	✓	✓ <sup>2)</sup>	–	–	–	

<sup>1)</sup> Information on the SIMATIC ET 200pro FC-2 frequency converter with PROFINET, PROFIBUS DP or EtherNet/IP – depending on the SIMATIC ET 200pro station – is available at [www.siemens.com/et200pro-fc](http://www.siemens.com/et200pro-fc)

<sup>2)</sup> Function possible with optional SINAMICS G120 Smart Access web server module.



## Overview

Protocol	Low voltage								
	Industry-specific frequency converters			Servo converters			High performance frequency converters		
	SINAMICS								
	G120P	G120X	G180	V90	S110	S210	S120 S120M	CU320-2	S150
CU230P-2		CB08		CU305		CU310-2	CU320-2	CU320-2	
<b>PROFINET</b>	✓	✓	✓ <sup>2)</sup>	✓	✓	✓	✓	✓	✓
- PROFINET RT	✓	✓	✓ <sup>2)</sup>	✓	✓	✓	✓	✓	✓
- PROFINET IRT isochronous	-	-	-	✓	✓	✓	✓	✓	✓
- PROFINET IRT not isochronous	✓	✓	-	✓	✓	✓	✓	✓	✓
- PROFINET Shared Device	✓	✓	-	-	✓	✓	✓	✓	✓
- PROFINET media redundancy MRP (step-change)	✓	✓	✓ <sup>2)</sup>	-	✓	✓	✓	✓	✓
- PROFINET media redundancy MRPD (bumpless)	✓	✓	-	-	✓	✓	✓	✓	✓
- System redundancy S2	-	-	✓ <sup>2)</sup>	-	-	-	✓	✓	✓
- PROFIsafe	-	-	-	-	✓	✓	✓	✓	✓
- PROFIenergy	✓	✓	-	-	-	✓	✓	✓	✓
- PROFIdrive application class 1	✓	✓	-	✓	✓	-	✓	✓	✓
- PROFIdrive application class 3	-	-	-	✓	✓	-	✓	✓	✓
- PROFIdrive application class 4	-	-	-	✓	✓	✓	✓	✓	✓
<b>PROFIBUS DP</b>	✓	✓	✓ <sup>2)</sup>	-	✓	-	✓	✓	✓
- PROFIBUS DP equidistance and isochronous mode	-	-	-	-	✓	-	✓	✓	✓
- PROFIBUS DP peer-to-peer communication	✓	✓	-	-	✓	-	✓	✓	✓
<b>EtherNet/IP</b>	✓	✓	-	-	-	-	-	✓	✓
<b>Modbus TCP</b>	-	-	✓ <sup>2)</sup>	-	-	-	✓	✓	✓
<b>Modbus RTU</b>	✓	✓	✓ <sup>2)</sup>	✓	-	-	-	-	-
<b>AS-Interface</b>	-	-	-	-	-	-	-	-	-
<b>BACnet MS/TP</b>	✓	✓	-	-	-	-	-	-	-
<b>CANopen</b>	-	-	✓ <sup>2)</sup>	-	-	-	-	-	-
<b>USS</b>	✓	✓	-	✓	✓	-	✓	✓	✓
<b>FLN P1</b>	✓	-	-	-	-	-	-	-	-
<b>Web server</b>	✓ <sup>1)</sup>	✓ <sup>1)</sup>	-	-	-	✓	✓	✓	✓

<sup>1)</sup> Function possible with optional SINAMICS G120 Smart Access web server module

<sup>2)</sup> Function possible with optional communications modules (additional PCBs) for SINAMICS G180.

# Communication

## PROFINET

### Overview



#### **PROFINET – the Ethernet standard for automation**

PROFINET is the world's leading Industrial Ethernet standard for automation with more than 40 million nodes installed worldwide.

PROFINET makes companies more successful, because it speeds up processes and raises both productivity and plant availability.

#### Your advantages at a glance

##### Flexibility

Tailor-made plant concepts

- ▶ Industrial Wireless LAN
- ▶ Safety
- ▶ Flexible topologies
- ▶ Open standard
- ▶ Web tools
- ▶ Expandability

##### Efficiency

Optimal use of resources

- ▶ One cable for everything
- ▶ Device/network diagnostics
- ▶ Energy efficiency
- ▶ Simple wiring
- ▶ Fast device replacement
- ▶ Ruggedness/stability

##### Performance

Increased productivity

- ▶ Speed
- ▶ High precision
- ▶ Large quantity structures
- ▶ High transmission rate
- ▶ Redundancy
- ▶ Fast start-up

G\_IK10\_XX\_10304

## Overview

### **Flexibility**

Short response times and optimized processes are the basic requirements for competitiveness in global markets because the product lifecycles are becoming shorter and shorter.

PROFINET ensures maximum flexibility in plant structures and production processes, and it enables you to implement innovative machine and plant concepts. For example, mobile devices can also be integrated at locations that are difficult to access.

### Flexible topologies

In addition to the linear structure characterized by the established fieldbuses, PROFINET also enables the use of star, tree and ring structures. This is made possible by switching technology via active network components, such as Industrial Ethernet switches and media converters, or by integrating switch functionality into the field devices. This results in increased flexibility in the planning of machines and plants, as well as savings in cabling.

The PROFINET network can be installed without any specialist knowledge at all and meets all requirements that are relevant to the industrial environment. The "PROFINET Installations Guidelines" assist manufacturers and users with network planning, installation and commissioning. Symmetrical copper cables or RFI-resistant fiber-optic cables are used, depending on the application. Devices from different manufacturers are easily connected via standardized and rugged plug-in connectors (up to IP65/IP67 degree of protection).

By integrating switch functionality into the devices, linear topologies can be created that are directly oriented toward an existing machine or plant structure. This reduces cabling overhead and cuts down on components such as external switches.

### IWLAN

PROFINET also supports wireless communication with Industrial Wireless LAN, thus opening up new fields of application. For example, technologies subject to wear, such as trailing cables, can be replaced and automated guided vehicle systems and mobile operator panels can be used.

### Safety

The PROFIsafe safety profile, which has been tried and tested with PROFIBUS and which permits the transmission of standard and safety-related data on a single bus cable, can also be used with PROFINET. No special network components are necessary for fail-safe communication, which means that standard switches and standard network transitions can continue to be used without any restrictions. In addition, fail-safe communication is equally possible via Industrial Wireless LAN (IWLAN).

### Open standard

PROFINET, the open multi-vendor standard (IEC 61158/IEC 61784), is supported by PROFIBUS and PROFINET International (PI). It stands for maximum transparency, open IT communication, network security and simultaneous real-time communication.

Thanks to its openness, PROFINET provides the basis for a standardized automation network in the plant, to which all other machines and devices can be connected. Even the integration of existing plant components, for example using PROFIBUS, presents no problems due to the use of network transitions.

### Use of web tools

Thanks to the unrestricted support of TCP/IP, PROFINET permits the use of standard web services such as web servers. Irrespective of the tool used, information from the automation level can be accessed from virtually any location using a commercially available internet browser. This considerably simplifies commissioning and diagnostics. Users can then decide for themselves how much openness to the IT world they want to allow for their machine or plant. This means that PROFINET can be used simply as an isolated plant network or connected via appropriate Security Modules, such as the SCALANCE S modules, to the office network or the internet. In this way, new remote maintenance concepts or the high-speed exchange of production data become possible.

### Expandability

On the one hand, PROFINET facilitates the integration of existing systems and networks without any great effort. In this way, PROFINET safeguards investments in existing plant components that communicate via PROFIBUS and other fieldbuses such as AS-Interface. On the other hand, additional PROFINET nodes can be added at any time. By using additional network components, network infrastructures can be expanded using cabling or wireless methods – even while the plant is operating.

## Communication

### PROFINET

#### Overview

##### **Efficiency**

Greater global competition means that companies must use their resources economically and efficiently. This applies in particular to production. This is where PROFINET ensures greater efficiency. Simple engineering guarantees fast commissioning, while reliable devices ensure a high level of plant availability. Comprehensive diagnostic and maintenance concepts help to reduce plant downtimes and keep maintenance costs to a minimum.

##### One cable for everything

PROFINET permits simultaneous fieldbus communication with isochronous mode and standard IT communication (TCP/IP) on one cable. This real-time communication for the transmission of user/process data and diagnostic data takes place on a single cable. Specific profile communication (PROFIsafe, PROFIdrive and PROFlenergy) can be integrated without any additional cabling. This solution offers a wide scope of functions at a low level of complexity.

##### Device and network diagnostics

By retaining the tried and tested PROFIBUS device model, the same diagnostics information is available with PROFINET. In addition, module-specific and channel-specific data can also be read out from the devices during device diagnostics, enabling faults to be located quickly and easily. Apart from the availability of device information, the reliability of network operation has top priority in the network management.

In existing networks the Simple Network Management Protocol (SNMP) has established itself as the de facto standard for the maintenance and monitoring of the network components and their functions. PROFINET uses this standard and gives users the opportunity to maintain their networks with tools that are familiar to them, such as the SINEMA Server network management software.

For easier maintenance of PROFINET devices, both on-site and remotely via a secure VPN connection, application-specific websites can be set up on the web server of the field devices using the familiar HTML standard.

##### Energy efficiency

Moving toward the green factory: PROFlenergy is a profile that provides functions and mechanisms for PROFINET field devices that support energy-efficient production.

The profile, which is defined by the PNO and is independent of any manufacturers or devices, enables energy demand and costs to be significantly reduced: Using PROFlenergy, any specific loads that are not currently being used can be switched off. This achieves a noticeable reduction in energy costs during breaks in production. PROFlenergy permits the simple, automated activation and deactivation of technologically related plant components. It is coordinated centrally by means of a higher-level controller and is networked via PROFINET. This ensures that as much energy as possible is saved during long breaks. Temporarily switching off plant components contributes to the even distribution and most efficient use of energy.

The use of PROFlenergy is made easy for the machine builder by its integration into familiar series of products. In addition, PROFlenergy is defined in such a way that the necessary function blocks can easily be integrated into existing automation systems at a later stage.

##### Simple wiring

Particularly stringent demands are made on the installation of cables in the industrial environment. In addition, there is a requirement to set up industry-standard networks in the shortest possible time without any special knowledge.

With FastConnect, Siemens offers a high-speed installation system that meets all of these requirements. FastConnect is the standard-compliant, industry-standard cabling system consisting of cables, connectors and assembly tools for PROFINET networks. The time required for connecting terminals is minimized by the simple installation method using just a single tool, while installation errors are prevented by the practical color-coding. Both copper cables and glass fiber optic cables can be easily assembled on site in this way.

##### Fast device replacement

PROFINET devices are identified by means of a name assigned during configuration. When replacing a defective device, a new device can be recognized from its topology information by the IO controller and a new name can be assigned to it automatically. This means that no engineering tool is necessary for the replacement of equipment.

This mechanism can even be used for the initial commissioning of a complete system. This speeds up commissioning, particularly in the case of series machines.

##### Ruggedness

An automation network must be able to withstand most external sources of interference. The use of Switched Ethernet prevents faults in one section of the network from affecting the entire plant network. For areas that are particularly prone to radio frequency interference (RFI), PROFINET allows the use of fiber optic cables.

##### **Performance**

Productivity and product quality determine the level of success in the market. Precise motion control, dynamic drives, high-speed controllers and the deterministic synchronization of devices are therefore key factors in achieving superior production. They facilitate high production rates and optimum product quality at the same time.

##### Speed and precision

Fast motion control applications demand precise and deterministic exchange of data. This is implemented by means of drive controllers using isochronous real time (IRT).

With IRT and isochronous mode, PROFINET permits fast and deterministic communication. This synchronizes the various cycles of a system (input, network, CPU processing and output), even in the case of parallel TCP/IP traffic. The short cycle times of PROFINET make it possible to raise the productivity of machines and plants and to guarantee the product quality and high level of precision.

The standardized PROFIdrive profile permits vendor-independent communication between CPUs and drives.

## Overview

### Large quantity structures

The use of PROFINET makes it possible to overcome the existing restrictions regarding the scope of machines and systems that can be implemented. In one network, several different controllers can interact with their assigned field devices. The number of field devices per PROFINET network is virtually unlimited – the entire range of IP addresses is available.

### High data rate

By using 100 Mbit/s in full duplex mode, PROFINET achieves a significantly higher data rate than previous fieldbuses. This means that other plant data can be transmitted over TCP/IP without any problems, in addition to the process data. PROFINET therefore meets the combined industrial demands for simultaneously transmitting high-speed IO data and large volumes of data for additional sections of the application. Even the transmission of large volumes of data, such as that from cameras, has no adverse effect on the speed and precision of the IO data transmission, thanks to PROFINET mechanisms.

### Media redundancy

A higher plant availability can be achieved with a redundant installation (ring topology). The media redundancy can be implemented not only with the aid of external switches, but also by means of integrated PROFINET interfaces. Using the media redundancy protocol (MRP), reconfiguration times of 200 ms can be achieved. If the communication is interrupted in just one part of the ring installation this means that a plant standstill is prevented and any necessary maintenance or repair work can be performed without any time pressure.

For motion control applications, PROFINET with IRT in ring topologies offers extended media redundancy for planned duplication (MRPD) which operates in a bumpless mode without any re-configuration time. If communication is interrupted (e.g. a cable break) the process can continue operating without interruption.

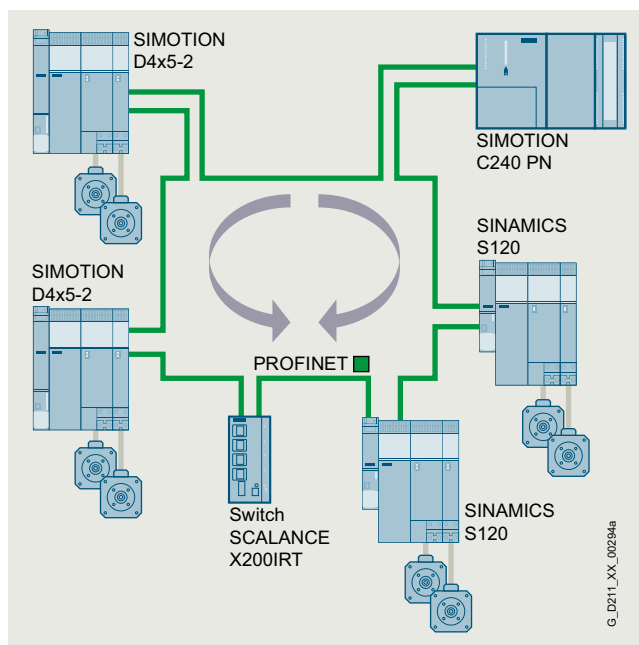

Bumpless media redundancy illustrated by example of SINAMICS S120 with SIMOTION and SCALANCE X200IRT

## Benefits

- PROFINET is the open Industrial Ethernet standard for automation
- PROFINET is based on Industrial Ethernet
- PROFINET uses TCP/IP and IT standards
- PROFINET is real-time Ethernet
- PROFINET enables seamless integration of fieldbus systems
- PROFINET supports fail-safe communication via PROFIsafe and also via IWLAN

## Integration

### PROFINET – SINAMICS S110 functions

SINAMICS S110	CU305 PN
PROFINET with IRT (isochronous mode)	✓
Number of ports	2
Min. send clock in ms	1
Shared Device	✓
Bumpless media redundancy (MRPD)	✓
Step-change media redundancy (MRP)	✓
PROFIsafe	✓
PROFIenergy	✓
PROFIdrive	✓

## More information

More information is available on the internet at:  
[www.siemens.com/profinet](http://www.siemens.com/profinet)

## Communication

### PROFIdrive

#### Overview



#### **PROFIdrive – the standardized drive interface for PROFINET and PROFIBUS**

PROFIdrive defines the device behavior and technique to access internal device data for electric drives connected to PROFINET and PROFIBUS – from basic frequency converters up to high-performance servo controllers.

It describes in detail the practical use of communication functions – device-to-device communication, equidistance and clock cycle synchronization (isochronous mode) in drive applications. In addition, it specifies all device characteristics which influence interfaces connected to a controller over PROFINET or PROFIBUS. This also includes the state machine (sequence control), the encoder interface, scaling of values, definition of standard telegrams, access to drive parameters, etc.

The PROFIdrive profile supports both central as well as distributed motion control concepts.

#### **What are profiles?**

For devices and systems used in automation technology, profiles define properties and modes of behavior. This allows manufacturers and users to define common standards. Devices and systems that comply with such a cross-manufacturer profile, are interoperable on a fieldbus and, to a certain degree, can be interchanged.

#### **Are there different types of profiles?**

A distinction is made between what are known as application profiles (general or specific) and system profiles:

- Application profiles (also device profiles) predominantly refer to devices (e.g. drives) and include an agreed selection regarding bus communication as well as specific device applications.
- System profiles describe classes of systems, including master functionality, program interfaces and integration resources.

#### **Is PROFIdrive fit for the future?**

PROFIdrive has been specified by the PROFIBUS and PROFINET International (PI) user organization, and is specified as a standard that is fit for the future through standard IEC 61800-7.

#### **The basic philosophy: Keep it simple**

The PROFIdrive profile tries to keep the drive interface as simple as possible and free from technology functions. As a result, referencing models as well as the functionality and performance of the PROFINET/PROFIBUS master have either no or only little influence on the drive interface.

#### **One drive profile – different application classes**

The integration of drives into automation solutions depends very strongly on the particular drive application. In order to be able to address the complete, huge bandwidth of drive applications – from basic frequency converters up to synchronized multi-axis systems with a high dynamic performance – using just one profile, PROFIdrive defines six application classes, to which most drive applications can be assigned:

- Class 1 – standard drives (pumps, fans, agitators, etc.)
- Class 2 – standard drives with technological functions
- Class 3 – positioning drives
- Class 4 – motion control drives with central, higher-level motion control intelligence and the patented "Dynamic Servo Control" positioning concept
- Class 5 – motion control drives with central, higher-level motion control intelligence and position setpoint interface
- Class 6 – motion control drives with distributed motion control intelligence integrated in the drives

#### **Design**

##### **The device model of PROFIdrive**

PROFIdrive defines a device model comprising function modules, which interoperate inside the device and which reflect the intelligence of the drive system. These modules have objects assigned to them which are described in the profile and are defined with respect to their functions. The overall functionality of a drive is therefore described through the sum of its parameters.

In contrast to other drive profiles, PROFIdrive defines only the access mechanisms to the parameters as well as a subset of profile parameters (approx. 30) such as the fault buffer, drive control and device identification.

All other parameters are vendor-specific which gives drive manufacturers great flexibility with respect to implementing control functions. The elements of a parameter are accessed acyclically over data records.

As a communication protocol, PROFIdrive uses DP-V0, DP-V1, and the DP-V2 expansions for PROFIBUS including the functions "Device-to-Device Communication" and "Isochronous Operation", or PROFINET IO with real-time classes RT and IRT.

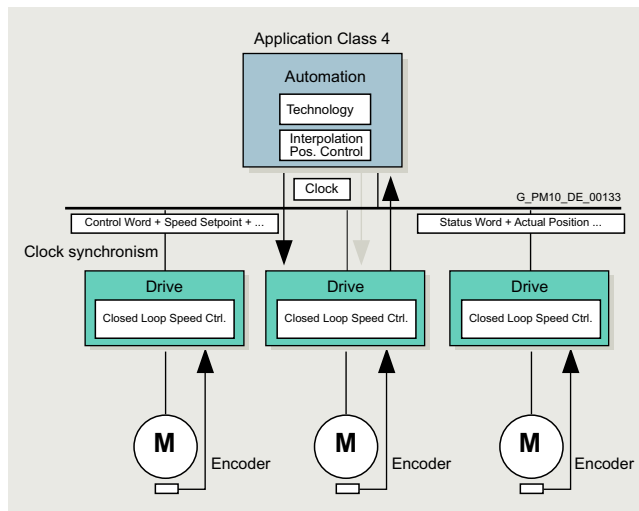

#### **More information**

More information on PROFINET and PROFIBUS is available at: [www.profinet.com](http://www.profinet.com)

## Overview



### **PROFIBUS – the proven, rugged bus system for automation engineering applications**

The requirements of users for an open, non-proprietary communication system have resulted in the specification and standardization of the PROFIBUS protocol.

PROFIBUS defines the technical and functional features of a serial fieldbus system, with which the distributed field automation devices in the lower area (sensor/actuator level) can be networked up to the mid performance range (cell level).

Standardization according to IEC 61158/EN 50170 secures your investments for the future.

Using the conformity and interoperability test performed by the test laboratories authorized by PROFIBUS & PROFINET International (PI) and the certification of the devices by PI, users have the security of knowing that the quality and functionality is guaranteed, even in multi-vendor installations.

### **PROFIBUS versions**

Two different PROFIBUS versions have been defined in order to comply with the widely varying requirements at field level:

- PROFIBUS PA (Process Automation) – the version for applications in process automation. PROFIBUS PA uses the intrinsically safe transmission technology specified in IEC 61158-2.
- PROFIBUS DP (Distributed Periphery) – this version, which is optimized for speed, is specifically tailored to the communication of automation systems with distributed I/O stations and drives. PROFIBUS DP sets itself apart as a result of very short response times and high noise immunity, and replaces cost-intensive, parallel signal transfer with 24 V and measured value transfer utilizing 0/4 ... 20 mA technology.

## Design

### **Bus participants on PROFIBUS DP**

PROFIBUS DP makes a distinction between two different master classes and one device class:

#### DP master class 1

For PROFIBUS DP, DP master class 1 is the central component. In a defined and continually repeating message cycle the central master station exchanges information with distributed stations (DP devices).

#### DP master class 2

Devices of this type (programming, configuring or operator control devices) are used during commissioning, for configuring the DP system, for diagnostics or for operating the active plant or system. A DP master class 2 can, for example, read input, output, diagnostic and configuration data of the devices.

### DP device

A DP device is an I/O device which receives output information or setpoints from the DP master, and as response, returns input information, measured values and actual values to the DP master. A DP device never sends data automatically, but only when requested by the DP master.

The quantity of input and output information depends on the device, and for each DP device in each send direction can be a maximum of 244 bytes.

## Function

### **Functional scope in DP masters and DP devices**

The functional scope can differ between DP masters and DP devices. The different functional scopes are classified as DP-V0, DP-V1 and DP-V2.

#### DP-V0 communication functions

The DP-V0 master functions consist of "Configuration", "Parameter Assignment" and "Reading Diagnostics Data", as well as cyclic reading of input data/actual values and writing output data/setpoints.

#### DP-V1 communication functions

The DP-V1 function expansions make it possible to perform acyclic read and write functions as well as processing cyclic data communication. This type of device must be supplied with extensive parameterization data during start-up and during normal operation. These acyclically transferred parameterization data are only rarely changed in comparison to the cyclic setpoints, actual values, and measured values, and are transferred at lower priority in parallel with the cyclic high-speed user data transfer. Detailed diagnostic information can be transferred in the same way.

#### DP-V2 communication functions

The extended DP-V2 master functions mainly comprise functions for isochronous operation and device-to-device communication between DP devices.

- Isochronous mode:  
Isochronous mode is implemented by means of an equidistant signal in the bus system. This cyclic, equidistant cycle is sent by the DP master to all bus nodes in the form of a Global Control Telegram. Master and devices can then synchronize their applications with this signal. The signal jitter between cycles is less than 1  $\mu$ s.
- Device-to-device communication:  
The "publisher/subscriber" model is used to implement device-to-device communication. Devices declared as publishers make their input data/actual values and measured values available to other devices, the subscribers, for reading. This is performed by sending the response frame to the master as a broadcast. Device-to-device communication is therefore a cyclic process.

## Integration

### **PROFIBUS with SINAMICS**

SINAMICS uses the PROFIBUS DP protocol. SINAMICS drives can only be used as DP devices.

# Communication

## Industrial Ethernet

### Overview



Ethernet is the basic internet technology for worldwide networking. The many possibilities of intranet and internet, which have been available for office applications for a long time, are now utilized for production automation with Industrial Ethernet.

Apart from the use of information technology, the deployment of distributed automation systems is also on the increase. This entails breaking up complex control tasks into smaller, manageable and drive-based control systems. This increases the demand for communication and consequently a comprehensive and powerful communication system.

Industrial Ethernet provides a powerful area and cell network for the industrial field, compliant with the IEEE 802.3 (ETHERNET) standard.

### Benefits

Ethernet enables a very fast data transfer (10/100 Mbit/s, 1/10 Gbit/s) and at the same time has full-duplex capability. It therefore provides an ideal basis for communication tasks in the industrial field. With a share of over 90 %, Ethernet is the number one network worldwide and offers important features which have essential advantages:

- Fast commissioning thanks to the simplest connection method
- High availability since existing networks can be extended without any adverse effects
- Almost unlimited communication performance because scalable performance is available through switching technology and high data rates when required
- Networking of different application areas such as office and production areas
- Company-wide communication based on WAN (Wide Area Network) technology or the internet
- Investment protection due to continuous compatibility with further developments
- Wireless communication using Industrial Wireless LAN

In order to make Ethernet suitable for industrial applications, considerable expansions with respect to functionality and design are required:

- Network components for use in harsh industrial environments
- Fast assembly of the RJ45 connectors
- Fail-safety through redundancy
- Expanded diagnostics and message concept
- Use of future-oriented network components (e.g. switches)

SIMATIC NET offers corresponding network components and products.

### Integration

#### **Industrial Ethernet with SINAMICS**

SINAMICS provides Control Units and Communication Boards with PROFINET interface based on 100 Mbit/s Ethernet. This means that process communication in real-time, as well as engineering and HMI via standard TCP/IP are simultaneously possible.

It is also possible to access the web server in SINAMICS at the same time that process communication is in progress.

The CU310-2 and CU320-2 Control Units have an additional Ethernet interface at the front so that service and engineering tasks can be performed very easily.

#### **Communication with SINAMICS over Industrial Ethernet**

##### PG/PC/HMI communication

PG/PC/HMI communication is performed using protocols which are based on the basic TCP/IP protocol.

- Engineering and diagnostics with STARTER and SINAMICS Startdrive

##### IT communication

IT communication is performed using protocols which are based on the basic TCP/IP protocol. The most important IT protocols are:

- HTTP/HTTPS: Hypertext Transfer Protocol (Secure)  
Using a standard internet browser, it is possible to retrieve pre-defined web pages containing diagnostic information from the device. Furthermore, user-defined web pages containing information defined by the user can be stored in the device.
- SNMP: Simple Network Management Protocol



## Overview

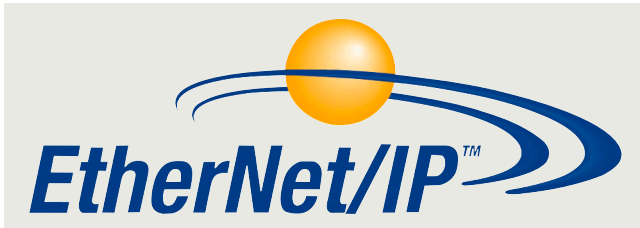

Ethernet Industrial Protocol (EtherNet/IP) is an open standard for industrial networks. EtherNet/IP is used to transmit cyclic I/O data and acyclic parameter data. EtherNet/IP was developed by the ODVA (Open DeviceNet Vendor Association) and belongs to the international standard series IEC 61158.

## Overview



As a simple fieldbus protocol, Modbus RTU can be used both cyclically and acyclically. Based on RS485 physical bus characteristics, up to 32 nodes can be networked to one bus segment and connected to a higher-level controller. This protocol is generally used when there are limited demands on data throughput.

## Overview



BACnet MS/TP (**B**uilding **A**utomation and **C**ontrol **N**etworks **M**ultidrop **S**erial/**T**oken **P**assing) is another fieldbus system based on the physical characteristics of RS485, which is mainly used in the field of building automation. BACnet MS/TP defines a variety of services including data utilization, alarm processing, event handling, processing of value changes, device and network management, as well as various types of objects. Interoperability is ensured by means of a uniform approach to services and procedures, which is laid down in "application profiles". These profiles are available for a wide range of applications. The SINAMICS G120P converters, especially developed for fluid flow machines (such as pumps, fans and compressor drives), use the application profile "BACnet application-specific controller" in building automation.

## Overview



CANopen is a communication protocol based on CAN physical characteristics, which is predominantly used in the automation industry and for networking within complex devices. Originally conceived as a fieldbus for networking devices in motion control applications such as handling systems, CANopen has since established itself in the field of medical engineering, vehicle automation, rail and ship networking as well as building automation. Interoperability of CANopen is ensured through the use of application and device profiles, whereby the wide range of options offered by the bus specification enables an appropriate, precise selection to be made for the application or device in question. Furthermore, converters with CANopen support the "CiA 402 Electrical Drives" device profile.

## Communication

### USS

#### Overview

As a simple fieldbus protocol, USS (**U**niversal **S**erial **I**nterface protocol of Siemens AG, 1992) can be used both cyclically and acyclically. Based on RS485 physical bus characteristics, up to 32 nodes can be networked to one bus segment and connected to a higher-level controller. This protocol is generally used when there are limited demands on data throughput.

### FLN P1

#### Overview

P1 is an asynchronous master-device communication between what is known as a Field Cabinet (master) and the FLN devices (devices). FLN stands for Floor Level Network. The master individually addresses the various devices. A device responds only if the master addresses it. Communication between the devices is not possible.

A Field Cabinet can have several FLN ports. Up to 32 FLN devices (devices) can be connected to each FLN port.

## Technology functions

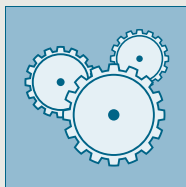
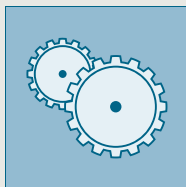
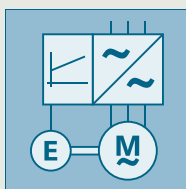

6/2

**Free function blocks (FFB)**

6/3

**Basic positioner EPos**

6/3

Function module basic positioner EPos

6/4

Functionality of the EPos basic positioner

## Technology functions

### Free function blocks (FFB)

#### Overview

On specific SINAMICS devices, free function blocks (FFB) are available as a standard technology function, which can be called up as an additively activatable function module. The FFB can be used to connect simple binary states or several input signals to a control signal (e.g. ON command). Furthermore, analog signals can also be adapted.

In addition to logical operations such as AND/OR, arithmetic functions as well as more complex blocks such as smoothing elements, limit monitors, or storing elements are also available. All of the blocks can be flexibly interconnected with one another using BICO (Binector-Connector technology).

In the SINAMICS Startdrive engineering tool, the FFB can be comfortably parameterized via screens.

The user-friendly overview for parameter assignment is shown below, based on the example of the SINAMICS G120 converter. In this example, three digital inputs which are linked to each other via a logical AND function block are acquired. The drive can only be released when all inputs have a HIGH signal.

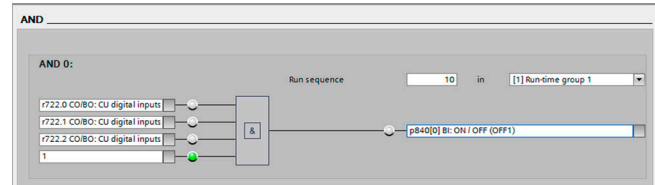

#### Supported functions in the function module of the free function blocks (FFB)

Logical functions	Programming of Boolean logic and logic operations
Arithmetic functions	Programming of mathematical functions
Timer functions	Generating of pulses and switching delays
Memory functions	Programming of binary flip-flops
Switch functions	Programming of binary and numerical switches
Control functions	Programming of functions for open-loop and closed-loop control
Complex functions	Programming of threshold value monitors and control units

The table above shows an overview of the supported functions of the FFB. Depending on the SINAMICS converter, up to 25 different block types are available. The number of available blocks per module type is limited. The blocks are not multi-instance-capable.

The sequence and calculation intervals (sampling times) can be selected for each block, but the calculation intervals are limited by the performance of the Control Unit.

## Overview

### Function module basic positioner EPos

The basic positioner EPos is available as a standard technology function for the following SINAMICS Control Units and can be called as a function module that can be activated additionally.

- SINAMICS S120 CU310-2 and CU320-2 Control Units
- SINAMICS S110 CU305 Control Units
- SINAMICS G120 CU250S-2 Control Units
- SINAMICS G120D CU250D-2 Control Units

The basic positioner can be used to resolve basic motion control tasks without additional external technological outlay from the drive itself.

### Integrated functionality for absolute and relative positioning of linear and rotary axes with motor encoders or machine encoders.

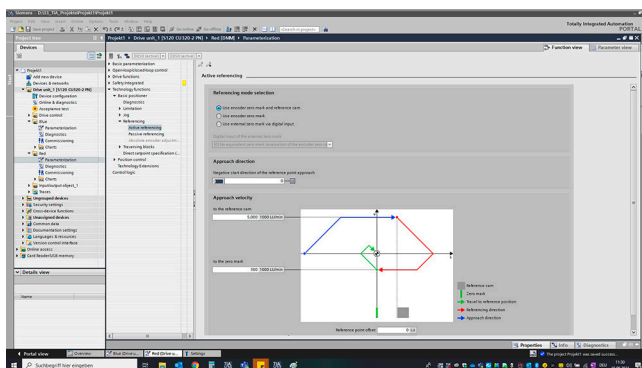
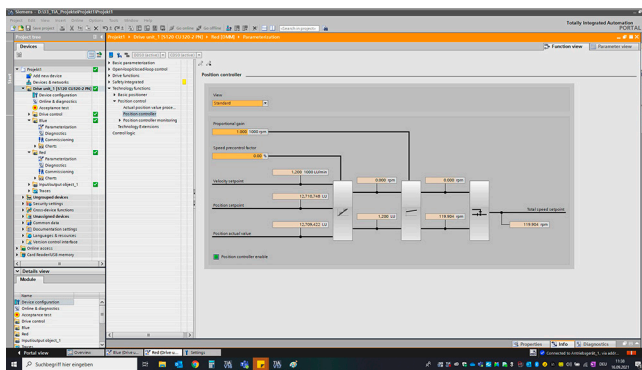

The EPos basic positioner in the SINAMICS drive system provides powerful and precise positioning functions. Due to its flexibility and adaptability, the basic positioner can be used for a wide range of positioning tasks.

The functions are easy to handle both during commissioning and during operation, and the comprehensive monitoring functions are outstanding.

Many applications can be carried out without external position controllers.

The EPos basic positioner is used to position linear and rotary axes (modulo) in absolute/relative terms with rotary as well as linear motor encoder or machine encoder (indirect or direct measuring system).

EPos is a function module that can be activated additionally in Servo Control and in Vector Control.

User-friendly configuring and commissioning, including control panel (operation using PC) and diagnostics, are possible with the STARTER and SINAMICS Startdrive commissioning tools.

In addition to extremely flexible positioning functions, EPos offers a high degree of user-friendliness and reliability thanks to integral monitoring and compensation functions.

Different operating modes and their functionality increase flexibility and plant productivity, for example, by means of "on-the-fly" and bumpless correction of the motion control.

Preconfigured PROFIdrive positioning frames are available which, when selected, automatically establish the internal "connection" to the basic positioner.

## Technology functions

### Basic positioner EPos

#### Overview

##### **Functionality of the EPos basic positioner**

##### Lower-level closed-loop position control with the following essential components

- Position actual value sensing (including the lower-level measuring probe evaluation and reference mark search)
- Position controller (including limits, adaptation and pre-control calculation)
- Monitoring functions (standstill, positioning and dynamic following error monitoring, cam signals)

##### Mechanical system

- Backlash compensation
- Modulo offset

##### Limitations

- Speed/acceleration/delay/jerk limitation
- Software limit switches (traversing range limitation by means of position setpoint evaluation)
- Stop cams (traversing range limitation using hardware limit switch evaluation)

##### Referencing or adjustment

- Set reference point (for an axis at standstill)
- Search for reference (separate mode including reversing cam functionality, automatic reversal of direction, homing to "output cam and encoder zero mark" or only "encoder zero mark" or "external zero mark (BERO)")
- Flying referencing (seamless referencing possible during "normal" traversing with the aid of the measuring input evaluation; generally evaluation, e.g. of a BERO. Subordinate function for the modes "jog", "direct setpoint input/MDI" and "traversing blocks")
- Absolute encoder alignment

##### Traversing block mode

- 64 traversing blocks for
  - SINAMICS S120 CU310-2 and CU320-2 Control Units
- 16 traversing blocks for
  - SINAMICS S110 CU305 Control Units
  - SINAMICS G120 CU250S-2 Control Units
  - SINAMICS G120D CU250D-2 Control Units
- Positioning using traversing blocks that can be stored in the drive unit including continuation conditions and specific jobs for a previously homed axis.
- Configuring traversing blocks using the traversing block editor in the relevant commissioning tool of the SINAMICS converter family
- A traversing block contains the following information:
  - Job number and job (e.g. positioning, waiting, GOTO block jump, setting of binary outputs, travel to fixed stop)
  - Motion parameters (target position, velocity, override for acceleration and deceleration)
  - Mode (e.g.: hide block, continuation conditions such as "Continue\_with\_stop", "Continue\_flying" and "Continue\_externally using high-speed measuring inputs")
  - Job parameters (e.g. wait time, block step conditions)

##### Direct setpoint specification (MDI) mode

- Positioning (absolute, relative) and setting-up (endless closed-loop position control) using direct setpoint inputs (e.g. via the PLC using process data)
- It is always possible to influence the motion parameters during traversing (on-the-fly setpoint acceptance) as well as for on-the-fly changes between the setup and positioning modes.
- The direct setpoint specification mode (MDI) can also be used in the relative positioning or setup mode if the axis is not referenced. This means that on-the-fly synchronization and re-referencing can be carried out using "flying referencing".

##### Jog mode

- Closed-loop position controlled traversing of the axis with "endless position controlled" or "jog incremental" modes (traverse through a "step width"), which can be toggled between

# SINAMICS V20 basic converters

## 0.12 kW to 30 kW (0.16 hp to 40 hp)



<b>7/2</b>	<b>Introduction</b>
7/2	Application
7/2	More information
<b>7/3</b>	<b>SINAMICS V20 basic converters</b>
7/3	Overview
7/3	Benefits
7/5	Application
7/6	Design
7/7	Function
7/9	Integration
7/10	Selection and ordering data
7/11	Technical specifications
7/15	Dimensional drawings
7/15	More information
<b>7/16</b>	<b>SINAMICS V20 starter kit</b>
7/16	Overview
7/16	Selection and ordering data
<b>7/17</b>	<b>Line-side components</b>
7/17	Line filters
7/20	Line reactors
7/22	Recommended line-side overcurrent protection devices
<b>7/23</b>	<b>DC link components</b>
7/23	Braking resistors
7/25	SINAMICS V20 Braking Module
<b>7/26</b>	<b>Load-side power components</b>
7/26	Output reactors
<b>7/28</b>	<b>Supplementary system components</b>
7/28	SINAMICS V20 Parameter Loader
7/29	SINAMICS V20 BOP and SINAMICS V20 BOP Interface
7/30	SINAMICS V20 Smart Access
7/31	SINAMICS V20 I/O Extension Module
7/32	SINAMICS V20 shield connection kits
7/32	SINAMICS V20 replacement fans

## SINAMICS V20 basic converters

0.12 kW to 30 kW (0.16 hp to 40 hp)

### Introduction

### Application

Use	Requirements for torque accuracy/speed accuracy/position accuracy/coordination of axes/functionality					
	Continuous motion			Non-continuous motion		
	Basic	Medium	High	Basic	Medium	High
<b>Pumping, ventilating, compressing</b>	Centrifugal pumps Radial / axial fans Compressors	Centrifugal pumps Radial / axial fans Compressors	Eccentric screw pumps	Hydraulic pumps Metering pumps	Hydraulic pumps Metering pumps	Descaling pumps Hydraulic pumps
	<b>V20</b> G120C G120X	G120X G130/G150 G180 <sup>1)</sup> DCM	S120	G120	S110	S120
<b>Moving</b>	Conveyor belts Roller conveyors Chain conveyors	Conveyor belts Roller conveyors Chain conveyors Lifting/lowering devices Elevators Escalators/moving walkways Indoor cranes Marine drives Cable railways	Elevators Container cranes Mining hoists Excavators for open-cast mining Test bays	Acceleration conveyors Storage and retrieval machines	Acceleration conveyors Storage and retrieval machines Cross cutters Reel changers	Storage and retrieval machines Robotics Pick & place Rotary indexing tables Cross cutters Roll feeds Engagers/disengagers
	<b>V20</b> G115D G120C ET 200pro FC-2 <sup>2)</sup>	G120 G120D G130/G150 G180 <sup>1)</sup>	S120 S150 DCM	V90 G120 G120D	S110 S210 DCM	S120 S210 DCM
<b>Processing</b>	Mills Mixers Kneaders Crushers Agitators Centrifuges	Mills Mixers Kneaders Crushers Agitators Centrifuges Extruders Rotary furnaces	Extruders Winders/unwinders Lead/follower drives Calenders Main press drives Printing machines	Tubular bagging machines Single-axis motion control such as • Position profiles • Path profiles	Tubular bagging machines Single-axis motion control such as • Position profiles • Path profiles	Servo presses Rolling mill drives Multi-axis motion control such as • Multi-axis positioning • Cams • Interpolations
	<b>V20</b> G120C	G120 G130/G150 G180 <sup>1)</sup>	S120 S150 DCM	V90 G120	S110 S210	S120 S210 DCM
<b>Machining</b>	Main drives for • Turning • Milling • Drilling	Main drives for • Drilling • Sawing	Main drives for • Turning • Milling • Drilling • Gear cutting • Grinding	Axis drives for • Turning • Milling • Drilling	Axis drives for • Drilling • Sawing	Axis drives for • Turning • Milling • Drilling • Laser cutting • Gear cutting • Grinding • Nibbling and punching
	S110	S110 S120	S120	S110	S110 S120	S120

With the compact SINAMICS V20 converter, Siemens offers a simple and economical drive solution for applications with simple motion sequences and basic requirements.

SINAMICS V20 sets itself apart with its quick commissioning times, ease of operation, robustness and cost-efficiency.

Practical application examples and descriptions are available on the internet at [www.siemens.com/sinamics-applications](http://www.siemens.com/sinamics-applications)

### More information

You may also be interested in these frequency converter:

- More performance for the control cabinet in IP20 degree of protection ⇒ SINAMICS G120C
- With positioning function in the control cabinet in IP20 degree of protection ⇒ SINAMICS G120
- With positioning function for distributed drive solutions in IP65 degree of protection ⇒ SINAMICS G120D (Catalog D 31.2)
- For HVAC, water and wastewater applications in the infrastructure sector for power range 0.75 kW to 630 kW ⇒ SINAMICS G120X (Catalog D 31.5)

<sup>1)</sup> Industry-specific converters.

<sup>2)</sup> Information on the SIMATIC ET 200pro FC-2 frequency converter is available in Catalog D 31.2 and at: [www.siemens.com/et200pro-fc](http://www.siemens.com/et200pro-fc)



## Overview



SINAMICS V20 converters, frame sizes: FSAA, FSAB, FSAC, FSAD, FSA, FSB, FSC, FSD, and FSE

### **SINAMICS V20 – The cost-effective, reliable and easy-to-use converter for basic applications**

Today, in an increasing number of applications in plant and machinery construction, individual automation and drive solutions are demanded that automate simple motion sequences with low associated requirements.

The compact SINAMICS V20, the basic performance converter, offers a simple and cost-effective drive solution for these types of applications. SINAMICS V20 sets itself apart with its quick commissioning times, ease of operation, robustness and cost-efficiency.

With nine frame sizes, it covers a power range extending from 0.12 kW to 30 kW (0.16 hp to 40 hp).

### **Minimizing costs**

SINAMICS V20 keeps engineering and commissioning costs as well as those in operation as low as possible. To increase energy efficiency, the converter is equipped with a control technique to achieve optimum energy efficiency through automatic flux reduction. Not only this, it displays the actual energy consumption and has additional, integrated energy-saving functions. This allows energy consumption to be slashed drastically.

7

## Benefits

### **Easy to install**

- Push-through and wall mounting
  - Side-by-side mounting possible for both
  - Compact installation allows smaller cabinets to be used
  - Push-through mounting for frame sizes FSB, FSC, FSD and FSE allows the cabinet to be cooled more easily
  - Frame sizes FSAA, FSAB, FSAC, and FSAD (230 V 1 AC) are significantly smaller compared to the previous frame sizes FSA, FSB, and FSC within the same power range
- Plug & Play
  - Can be run "out-of-the-box" without other options
  - Basic operator actions at a built-in BOP (Basic Operator Panel)
- Connection of SINAMICS V20 with USS or Modbus RTU via terminals
  - Easy integration into existing systems
  - Easier commissioning through standard libraries and connection macros
  - Full flexibility of Modbus RTU settings widens communication with controller
  - Simple connection to a control system (e.g. SIMATIC S7 PLC via Modbus RTU/USS)
- Integrated Braking Module
  - Converters  $\geq 7.5$  kW (frame sizes FSD and FSE) have an integrated Braking Module. In this case, the braking resistor can be directly connected. The dynamic energy is dissipated as heat in a braking resistor with an adjustable duty cycle of between 5 % and 100 %.
  - Possible to use dynamic braking to increase braking performance
- EMC category C1
  - The devices are optionally available with an integrated RFI suppression filter, enabling compliance with the radio interference limit values laid out in IEC 61800-3 category C1 when installed in the control cabinet in an EMC-compliant manner. Frame sizes FSAA, FSAB, FSAC, and FSAD therefore satisfy the radio interference requirements for industrial applications as well as for use in residential and business environments, including commercial applications such as refrigerated counters, fitness equipment, ventilation systems, industrial washing machines, etc.

## SINAMICS V20 basic converters

0.12 kW to 30 kW (0.16 hp to 40 hp)

### SINAMICS V20 basic converters

#### Benefits

##### Easy to use

- Parameter settings can be easily transferred from one unit to another using the battery-operated parameter loader.
  - Less technical support required
  - Short commissioning time
  - The product is delivered to the customer already preset
- Integrated connection and application macros
  - To simplify I/O configuration and make the appropriate settings
  - Shorter commissioning time
  - Integrated and optimized application setting
  - Simple connection and application macros can be selected instead of configuring long, complicated parameter lists
  - Errors caused by wrong parameter settings can be avoided
- Keep Running Mode allows uninterrupted operation
  - This function provides higher productivity in production by automatic adaptation in the case of unstable line supplies
  - Stable operation under difficult line supply conditions
  - Higher productivity through prevention of interruptions to the production line
  - Adaptation to application-relevant reactions through flexible definition in case of faults/alarms
- Wide voltage range, advanced cooling design and coated PCBs increase robustness of the drive in difficult environments
  - Operation possible when the line supply voltage fluctuates
  - Reliable operation at line voltages:
    - 200 V ... 240 V 1 AC (-15 %/+10 %) <sup>1)</sup>
    - 380 V ... 480 V 3 AC (-15 %/+10 %)
  - Operating and ambient temperatures between -10 °C and +40 °C (max. +60 °C with derating)
- Wireless commissioning, operation and diagnostics via mobile device or laptop thanks to the optional web server module SINAMICS V20 Smart Access
  - Enables easy access to the converter, even when it is installed in difficult-to-access areas
  - Simple operation thanks to intuitive user interface and commissioning wizard
  - Flexible choice of terminal devices as the web server works with every HTML5-compatible web browser
- Expansion of the 400 V converters with two digital inputs and two digital outputs (relay outputs) thanks to optional SINAMICS V20 I/O Extension Module
  - Higher flexibility of the frequency converter without additional outlay for installation, hardware and software
  - Additional functionalities such as multi-pump control, with which up to four pumps can be controlled with a frequency converter

##### Easy to save money

Energy reduction during operation and standby

- ECO mode for V/f, V<sup>2</sup>/f
  - The integrated ECO mode for V/f, V<sup>2</sup>/f control automatically adapts the magnetic flux in the motor to save energy. The energy consumption can be shown in kWh, CO<sub>2</sub> or even in the local currency.
  - Energy saving during low dynamic load cycles
  - Specifies the actual energy that has been saved
- Hibernation mode
  - Converter and motor are only activated when used by the plant or machine
  - Smart hibernation saves energy
  - Motor service life is extended
  - Reduced pump wear at low speed
  - Less time needed to program PLC code for pump/fan applications (PLC)
- DC link coupling
  - Applications that use SINAMICS V20 drives with the same power rating can share a common DC bus to reuse the regenerative energy
  - Generate and save energy in applications that use coupled motors
  - The converters can then optimally share the load mutually.
  - Reduce the need for dynamic braking and external components

##### Integrated energy flow monitoring

- Energy consumption and savings are monitored without the need for power measurement equipment
  - Intuitive values of power consumption and savings without additional investments for measurement equipment
  - Values can be shown as kWh, CO<sub>2</sub> or as a currency

##### Cost-savings for low-overload applications with SINAMICS V20 converters, frame size FSE

SINAMICS V20 frame size FSE converters feature two different load cycles:

- Low overload (LO):  $110\% \times I_L^{2)}$  for 60 s (cycle time: 300 s)
- High overload (HO):  $150\% \times I_H^{3)}$  for 60 s (cycle time: 300 s)

With the low-overload cycle, the converter can reach a higher output current and power.

A smaller converter can be used. Optimally designed for variable applications:

- Low overload for applications with a low dynamic response (continuous duty)
- High overload for applications with a high dynamic response (cyclic duty)

<sup>1)</sup> Single-phase devices can also be connected to two phases of a three-phase 240 V power supply system. The voltage between L1 and L2 should be within the range of 200 V to 240 V, -15 % to +10 % (phase-phase or phase-neutral conductor). Further information can be found at: <https://support.industry.siemens.com/cs/document/109476260>

<sup>2)</sup> The output current  $I_L$  is based on the duty cycle for low overload (LO).

<sup>3)</sup> The output current  $I_H$  is based on the duty cycle for high overload (HO).

## Benefits

### Complete motion control solutions from Siemens – SINAMICS V20 and SIMATIC

Siemens offers comprehensive solutions from a single source for general motion control applications with a selection of different SINAMICS application examples:

- Ready-to-run application examples, including wiring diagrams, parameter descriptions
- Sample configurations for connecting SINAMICS with SIMATIC, including hardware, software and wiring examples, installation instructions for the supplied S7 project, drive parameterization, and HMI sample projects
  - Correctly configured project, ready for operation
  - Optimal leveraging of TIA advantages
  - Free download via the Online Support portal: [www.siemens.com/sinamics-applications](http://www.siemens.com/sinamics-applications)

### Extended warranty

For SINAMICS V20, Siemens offers an optional extension of warranty up to 5½ years via **Service Protect**:

- Free for the first 6 months after registering the product at: <https://myregistration.siemens.com>
- Subject to a charge for a further 3 or 5 years

For further information, go to: <https://support.industry.siemens.com/cs/ww/en/sc/4842>

Concerning standard warranty please ask your partner at Siemens. Your partner can be found in our Personal Contacts Database at:

[www.siemens.com/automation-contact](http://www.siemens.com/automation-contact)

## Application

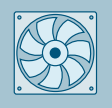
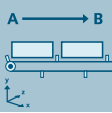
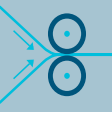
Typical applications		Advantages	
<b>Pumping, ventilating, compressing</b>		<b>Advantages</b>	
	<ul style="list-style-type: none"> <li>• Centrifugal pumps</li> <li>• Radial/axial fans</li> <li>• Compressors</li> </ul>	<ul style="list-style-type: none"> <li>• High availability through automatic restart and flying restart after power failures</li> <li>• Broken belt detection by monitoring the load torque</li> <li>• Pump protection against cavitation</li> <li>• Hammer start and blockage clearing modes for clogged pumps</li> <li>• PID controller for process values (e.g. temperature, pressure, level, flow)</li> <li>• PID auto tuning to optimize controller parameters</li> <li>• Hibernation mode stops the motor when demand is low</li> <li>• Motor staging extends the flow range by adding two more fixed-speed drives (cascade)</li> <li>• Frost and condensation protection prevents moisture in motors under extreme environmental conditions</li> <li>• With optional SINAMICS V20 I/O Extension Module for 400 V converters: Multi-pump control <sup>1)</sup>, with which up to four pumps can be controlled with a frequency converter and applications that require additional digital inputs and digital outputs (e.g. in water supply systems for buildings)</li> </ul>	
<b>Moving</b>		<b>Advantages</b>	
	<ul style="list-style-type: none"> <li>• Conveyor belts</li> <li>• Roller conveyors</li> <li>• Chain conveyors</li> <li>• Moving walkways</li> <li>• Bucket conveyors</li> </ul>	<ul style="list-style-type: none"> <li>• Soft, jerk-free acceleration reduces the stress on the gear units, bearings, drums and rollers</li> <li>• Super torque start for conveyor belts with high breakaway torque</li> <li>• Dynamic behavior by using braking resistor or DC braking</li> <li>• Direct control of mechanical holding brake</li> <li>• Broken belt detection by monitoring the load torque</li> <li>• Precise stopping with Quick Stop (switch-off positioning) independently of the control cycle</li> </ul>	
<b>Processing</b>		<b>Advantages</b>	
	<ul style="list-style-type: none"> <li>• Single drives in the processing industry such as mills, mixers, kneaders, crushers, agitators, centrifuges</li> <li>• Single drives in commercial applications such as ovens, mixers, industrial washing machines</li> <li>• Main drives in machines with mechanically coupled axes such as spinning machines, braiding machines for textiles, ropes and wires</li> </ul>	<ul style="list-style-type: none"> <li>• Frost and condensation protection prevents moisture in motors under extreme environmental conditions</li> <li>• Higher productivity with uninterrupted production due to Keep Running Mode</li> <li>• Exchange of regenerative energy via the DC link</li> <li>• Super torque start for machines with a high breakaway torque</li> </ul>	

<sup>1)</sup> Further information on the multi-pump control can be found in the operating instructions and on the internet at: [www.siemens.com/sinamics-v20/documentation](http://www.siemens.com/sinamics-v20/documentation)

# SINAMICS V20 basic converters

0.12 kW to 30 kW (0.16 hp to 40 hp)

## SINAMICS V20 basic converters

### Design

7

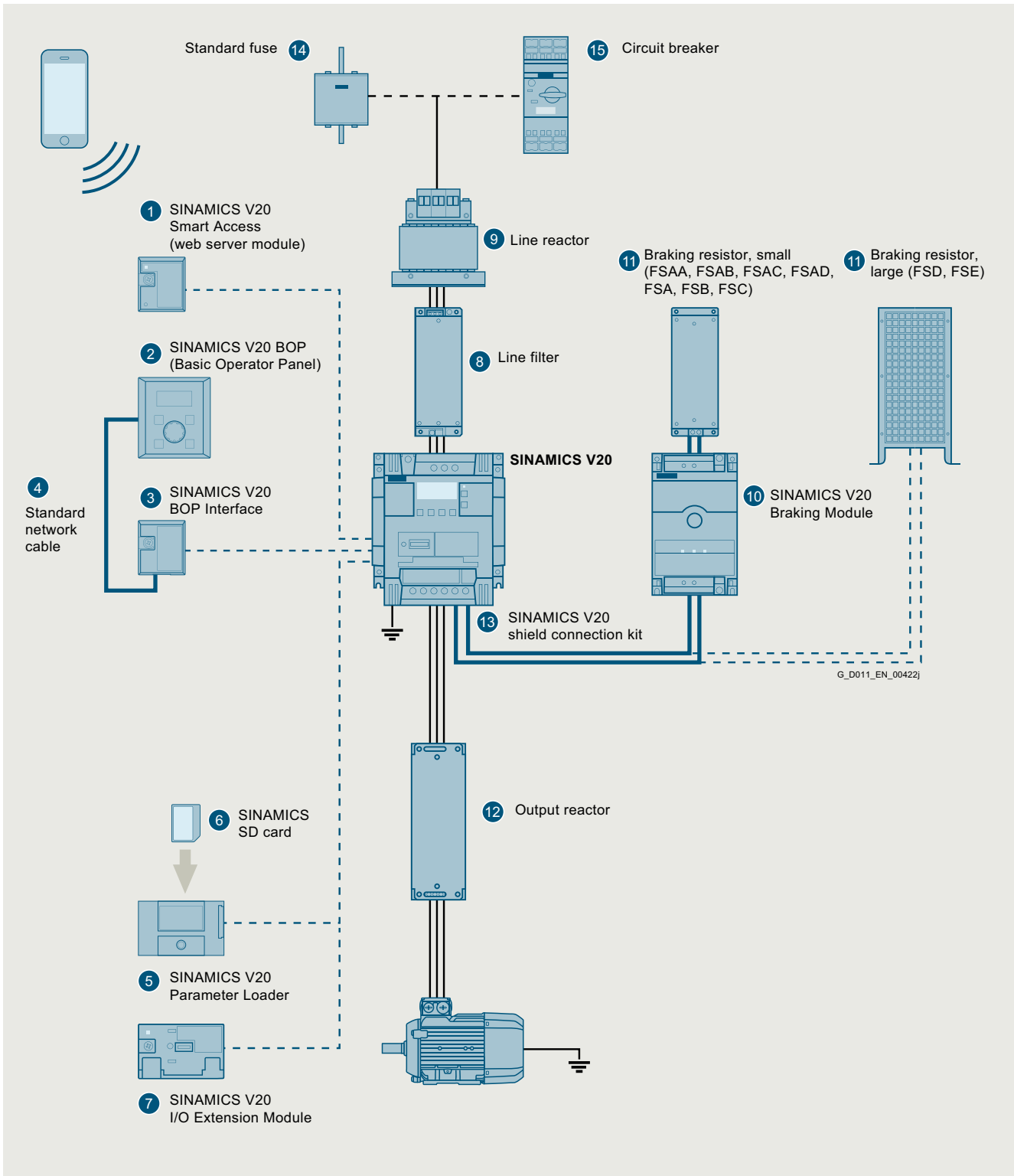

SINAMICS V20 converter and accessories

## Design

Accessories		
①	<b>SINAMICS V20 Smart Access</b>	Wireless commissioning, operation, and diagnostics with mobile device or laptop using web server module
②	<b>SINAMICS V20 BOP</b>	<ul style="list-style-type: none"> <li>• Same function as the integrated BOP (Basic Operator Panel)</li> <li>• Can also be used for remote mounting</li> <li>• Values and setpoints are changed by rotating the wheel</li> <li>• For distributed mounting with IP54 and UL Type 1 enclosure rating</li> </ul>
③	<b>SINAMICS V20 BOP Interface</b>	<ul style="list-style-type: none"> <li>• RJ45 interface is compatible with standard network cable</li> </ul>
④	<b>Standard network cable</b>	<ul style="list-style-type: none"> <li>• Cable not included in delivery</li> <li>• You can use any standard network cable with standard RJ45 connector</li> </ul>
⑤	<b>SINAMICS V20 Parameter Loader</b>	<ul style="list-style-type: none"> <li>• Up to 100 parameter sets with parameter settings can be written from the memory card to the converter, or saved from the converter to the memory card</li> <li>• The converter does not have to be connected to the line supply</li> </ul>
⑥	<b>SINAMICS SD card</b>	<ul style="list-style-type: none"> <li>• Memory card, 512 MB</li> <li>• Standard SD cards up to 32 GB are supported</li> </ul>
⑦	<b>SINAMICS V20 I/O Extension Module</b>	<ul style="list-style-type: none"> <li>• Expansion of the 400 V converters with two digital inputs and two digital outputs (relay outputs)</li> </ul>
⑧	<b>Line filter</b>	Improved EMC characteristics
⑨	<b>Line reactor</b>	<ul style="list-style-type: none"> <li>• Reduces the harmonic current</li> <li>• Improves the power factor</li> <li>• Recommended if input current (rms value) is higher than the rated current of the converter</li> </ul>
⑩	<b>SINAMICS V20 Braking Module</b>	<ul style="list-style-type: none"> <li>• Shortens the deceleration ramp time</li> <li>• Suitable for 230 V 1 AC and 400 V 3 AC</li> <li>• Adjustable duty cycle from 5 % to 100 %</li> <li>• For frame sizes FSAA, FSAB, FSAC, FSAD, FSA, FSB, and FSC</li> <li>• FSD and FSE already have an integrated braking unit</li> </ul>
⑪	<b>Braking resistor</b>	<ul style="list-style-type: none"> <li>• Dissipates regenerative energy as heat</li> <li>• 5 % duty cycle as default setting</li> </ul>
⑫	<b>Output reactor</b>	<p>For longer motor cable</p> <ul style="list-style-type: none"> <li>• 230 V 1 AC: 200 m (shielded and unshielded)</li> <li>• 400 V 3 AC: <ul style="list-style-type: none"> <li>- for frame sizes FSA to FSD: 150 m (shielded and unshielded)</li> <li>- for frame size FSE: 200/300 m (shielded/unshielded)</li> </ul> </li> </ul>
⑬	<b>Shield connection kit</b>	<ul style="list-style-type: none"> <li>• Shield connection</li> <li>• Strain relief</li> </ul>
⑭	<b>Standard fuse</b>	Recommended fuse corresponding to the IEC/UL standard
⑮	<b>Circuit breaker</b>	Recommended circuit breaker corresponding to the IEC/UL standard

## Function

Feature	Comment
<b>Connection and application macros</b>	<p>Sets groups of parameters to simplify commissioning</p> <ul style="list-style-type: none"> <li>• Connection macros for connections</li> <li>• Application macros for applications</li> </ul>
<b>Keep Running Mode</b>	<p>Single-parameter setting for a mode which keeps the motor going – enables</p> <ul style="list-style-type: none"> <li>• <math>V_{dc\_max}</math> controller</li> <li>• Kinetic buffering</li> <li>• Restart after fault</li> <li>• Flying start.</li> <li>• Disables alarms etc.</li> </ul>

Feature	Comment
<b>ECO mode</b>	Economy mode – searches for most efficient rated point
<b>Hibernation mode</b>	Intelligent economy mode in idle state
<b>PID controller</b>	Integrated PID controller with auto-tuning function
<b>Kinetic buffering (<math>V_{dc\_min}</math> controller)</b>	Retention of minimal DC voltage through regenerative energy for continued operation
<b><math>V_{dc\_max}</math> controller</b>	Automatic change of ramp down time/braking time
<b><math>I_{max}</math> controller</b>	Automatic change of ramp up time to avoid overcurrent

## SINAMICS V20 basic converters

0.12 kW to 30 kW (0.16 hp to 40 hp)

### SINAMICS V20 basic converters

#### Function

Feature	Comment
<b>Automatic restart</b>	Automatic restart of drive once the power has been restored following a power failure. All faults are acknowledged automatically and the drive is switched on again
<b>Flying restart</b>	Allows the converter to be switched to a rotating motor
<b>Energy consumption monitoring</b>	Displays a simple estimate of energy or cost saved against use of a line-connected motor
<b>50/60 Hz adaptation</b>	Easy selection of operation with 50 Hz (Europe, Asia) / 60 Hz (USA)
<b>V/f and V<sup>2</sup>/f</b>	V/f: perfectly suitable for almost any application in which the speed of asynchronous (induction) motors is to be changed V <sup>2</sup> /f: suited to loads with quadratic load curves, e.g. turbo machines such as pumps and fans
<b>FCC</b>	Maintains motor flux current for improved efficiency
<b>Programmable V/f coordinates</b>	Freely adjusts the V/f characteristics, e.g. torque behavior of the synchronous motor
<b>JOG</b>	Moves the motor to test the direction or moves the load to specific position. When the BOP switches to JOG mode, pressing the start button of the BOP will run the motor up to the JOG frequency. Releasing the start button stops the motor
<b>DC braking</b>	Stops the motor which runs at constant speed and only comes to a standstill in longer time intervals, e.g. centrifuges, saws, grinding machines and conveyor belts
<b>Mechanical holding brake control</b>	The motor holding brake prevents the motor from undesirable turning when the converter is switched off. The converter has an internal logic to control an external motor holding brake
<b>USS</b>	Universal Serial Interface Protocol
<b>Modbus RTU</b>	Modbus RTU communication available via the RS485 link
<b>Super torque mode</b>	Big torque boost for starting high-inertia applications
<b>Hammer start mode</b>	A number of torque pulses at start-up to start difficult or "stuck" loads
<b>Blockage clearing mode</b>	Multiple-reverse function to clear blocked pumps
<b>Simple parameter-based menu on internal or external BOPs</b>	Easy selection for displaying values, editing parameters, converter setup
<b>Simple text menu for setup</b>	The parameter number will be shown as short text in the 7-segment LED display
<b>Motor frequency display scaling</b>	User settable display scaling for special applications i.e. rather than Hz, it shows application-specific values like "gallons per minute", "potatoes per hour", etc.

Feature	Comment
<b>Customization of parameter defaults</b>	Customers or OEMs can set their own special "permanent" defaults which can only be deleted in special mode
<b>Converter status in case of a fault</b>	Record the fault with running data <ul style="list-style-type: none"> <li>• Fault code</li> <li>• Drive setpoint</li> <li>• Drive status</li> <li>• DC link voltage</li> <li>• Output current</li> <li>• Output voltage</li> </ul>
<b>List of modified parameters</b>	When this filter is activated, the parameter list only displays the parameters which were modified by users
<b>Load torque monitoring</b>	Detects the load torque to establish failure of the mechanical connection between motor and load machine, overload, motor blocking or no-load operation, e.g. in the event of a V-belt tear in a fan or when a load machine jams
<b>Phase loss detection</b>	Detects and protects against phase loss
<b>Cavitation protection</b>	Protects against cavitation damage to pumps
<b>Condensation protection</b>	Automatic application of DC current to motor to protect from condensation
<b>Frost protection</b>	Automatically rotates motor to stop fluids freezing when temperature falls near or below freezing e.g. for the sequential connection of multiple pumps working in one system
<b>Motor staging</b>	Automatic control and staging of several motors
<b>Multi-pump control <sup>1)</sup></b>	Control of up to four pumps with a frequency converter by means of optional SINAMICS V20 I/O Extension Module
<b>Dual ramp parameterizable</b>	Switchable ramps for specific applications
<b>Programmable fixed frequency setpoint</b>	16 fixed frequencies can be defined and switched by digital inputs or communication
<b>Drive data sets (DDS)</b>	3 parameter sets for the motor and load. The user can switch the parameter set to suit the motors and applications
<b>Command data sets (CDS)</b>	3 parameter sets for the setpoint and command. The user can switch the parameter set to suit the control system
<b>Flexible voltage boost</b>	Increases the output voltage to compensate resistive losses or increase the output torque
<b>Skippable frequency bandwidth</b>	Defines 1 to 4 frequencies to avoid effects of mechanical resonance and suppress frequencies within an adjustable skip frequency bandwidth
<b>2-wire/3-wire control</b>	The wide range of setting options is especially intended to allow emulation of existing control methods on the plant or system side if the converter has to be integrated into an existing application

<sup>1)</sup> Further information on the multi-pump control can be found in the operating instructions and on the internet at: [www.siemens.com/sinamics-v20/documentation](http://www.siemens.com/sinamics-v20/documentation)

# SINAMICS V20 basic converters

0.12 kW to 30 kW (0.16 hp to 40 hp)

## SINAMICS V20 basic converters

### Integration

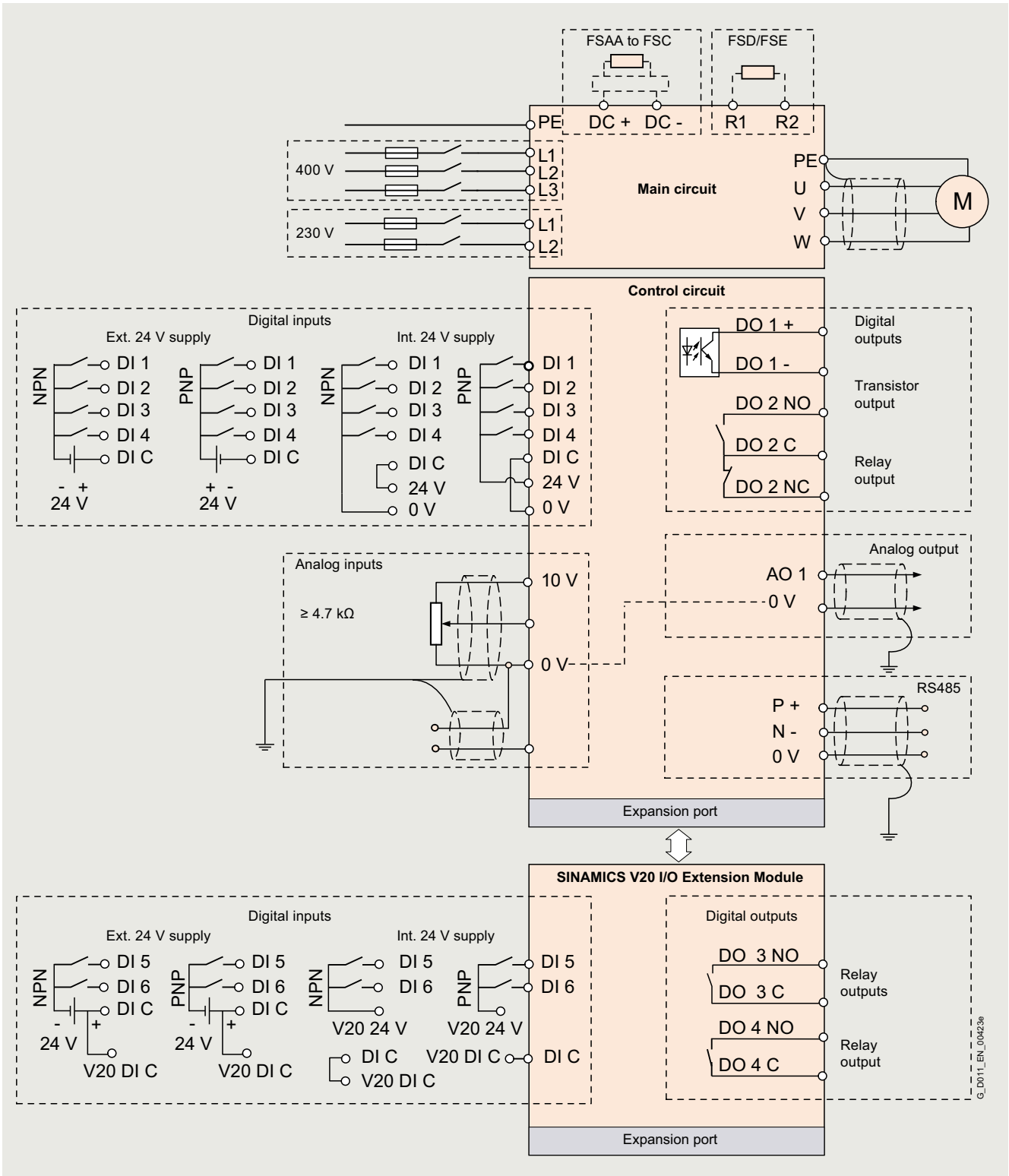

Connection example for SINAMICS V20

## SINAMICS V20 basic converters

0.12 kW to 30 kW (0.16 hp to 40 hp)

### SINAMICS V20 basic converters

#### Selection and ordering data

Rated power <sup>1)</sup>		Rated input current	Output current $I_H$ <sup>2)</sup>	Fan	Frame size	SINAMICS V20 without integrated line filter	SINAMICS V20 with integrated line filter Category C1 <sup>3)</sup>
kW	hp	A	A			Article No.	Article No.
<b>200 ... 240 V 1 AC <sup>4)</sup></b>							
0.12	0.16	2.3	0.9	–	FSAA	6SL3210-5BB11-2UV1	6SL3210-5BB11-2BV1
0.25	0.33	4.5	1.7	–	FSAA	6SL3210-5BB12-5UV1	6SL3210-5BB12-5BV1
0.37	0.5	6.2	2.3	–	FSAA	6SL3210-5BB13-7UV1	6SL3210-5BB13-7BV1
0.55	0.75	7.7	3.2	–	FSAB	6SL3210-5BB15-5UV1	6SL3210-5BB15-5BV1
0.75	1	10	4.2	–	FSAB	6SL3210-5BB17-5UV1	6SL3210-5BB17-5BV1
1.1	1.5	14.7	6	1	FSAC	6SL3210-5BB21-1UV1	6SL3210-5BB21-1BV1
1.5	2	19.7	7.8	1	FSAC	6SL3210-5BB21-5UV1	6SL3210-5BB21-5BV1
2.2	3	27.2	11	1	FSAD	6SL3210-5BB22-2UV1	6SL3210-5BB22-2BV1
3	4	32	13.6	1	FSAD	6SL3210-5BB23-0UV1	6SL3210-5BB23-0BV1

Rated power <sup>5)</sup>		Rated input current	Output current $I_L$ <sup>6)</sup>	Power based on the output current $I_H$ <sup>2)</sup>		Output current $I_H$ <sup>2)</sup>	Fan	Frame size	SINAMICS V20 without integrated line filter	SINAMICS V20 with integrated line filter Category C3 <sup>7)</sup>
kW	hp	A	A	kW	hp	A			Article No.	Article No.
<b>380 ... 480 V 3 AC</b>										
0.37	0.5	1.7	1.3/1.3	0.37	0.5	1.3/1.3	–	FSA	6SL3210-5BE13-7UV0	6SL3210-5BE13-7CV0
0.55	0.75	2.1	1.7/1.7	0.55	0.75	1.7/1.7	–	FSA	6SL3210-5BE15-5UV0	6SL3210-5BE15-5CV0
0.75	1	2.6	2.2/2.2	0.75	1	2.2/2.2	–	FSA	6SL3210-5BE17-5UV0	6SL3210-5BE17-5CV0
1.1	1.5	4	3.1/3.1	1.1	1.5	3.1/3.1	1	FSA	6SL3210-5BE21-1UV0	6SL3210-5BE21-1CV0
1.5	2	5	4.1/4.1	1.5	2	4.1/4.1	1	FSA	6SL3210-5BE21-5UV0	6SL3210-5BE21-5CV0
2.2	3	6.4	5.6/4.8	2.2	3	5.6/4.8	1	FSA	6SL3210-5BE22-2UV0	6SL3210-5BE22-2CV0
3	4	8.6	7.3/7.3	3	4	7.3/7.3	1	FSB	6SL3210-5BE23-0UV0	6SL3210-5BE23-0CV0
4	5	11.3	8.8/8.24	4	5	8.8/8.24	1	FSB	6SL3210-5BE24-0UV0	6SL3210-5BE24-0CV0
5.5	7.5	15.2	12.5/11	5.5	7.5	12.5/11	1	FSC	6SL3210-5BE25-5UV0	6SL3210-5BE25-5CV0
7.5	10	20.7	16.5/16.5	7.5	10	16.5/16.5	2	FSD	6SL3210-5BE27-5UV0	6SL3210-5BE27-5CV0
11	15	30.4	25/21	11	15	25/21	2	FSD	6SL3210-5BE31-1UV0	6SL3210-5BE31-1CV0
15	20	38.1	31/31	15	20	31/31	2	FSD	6SL3210-5BE31-5UV0	6SL3210-5BE31-5CV0
22	30	54/45 <sup>8)</sup>	45/40	18.5	25	38/34	2	FSE	6SL3210-5BE31-8UV0	6SL3210-5BE31-8CV0
30	40	72/54 <sup>8)</sup>	60/52	22	30	45/40	2	FSE	6SL3210-5BE32-2UV0	6SL3210-5BE32-2CV0

<sup>1)</sup> Rated power of the 230 V 1 AC devices based on the output current  $I_H$ . The output current  $I_H$  is based on the duty cycle for high overload (HO): 150 %  $I_H$  for 60 s within a cycle time of 300 s.

<sup>2)</sup> The output current  $I_H$  is based on the duty cycle for high overload (HO): 150 %  $I_H$  for 60 s within a cycle time of 300 s.

<sup>3)</sup> EN 61800-3 Category C1, 1st environment (residential, commercial). Max. shielded motor cable length 5 m for frame sizes FSAA, FSAB, and FSAD, and 10 m for frame size FSAC - with or without external line filter.

<sup>4)</sup> Single-phase devices can also be connected to two phases of a 3-phase 230 V power supply system. You can find detailed information here: <https://support.industry.siemens.com/cs/document/109476260>

<sup>5)</sup> Rated power of the 400 V 3 AC devices based on the output current  $I_L$ . The output current  $I_L$  is based on the duty cycle for low overload (LO): 110 %  $I_L$  for 60 s within a cycle time of 300 s.

<sup>6)</sup> The output current  $I_L$  is based on the duty cycle for low overload (LO): 110 %  $I_L$  for 60 s within a cycle time of 300 s.

<sup>7)</sup> EN 61800-3 Category C3, 2nd environment (industrial). Shielded motor cable length for frame size FSA max. 10 m, for frame sizes FSB to FSD max. 25 m and for frame size FSE max. 50 m. To achieve 25 m of shielded motor cable length, even for C2 category FSA converters, unfiltered converters with external line filters must be used.

<sup>8)</sup> Regarding the first value, the rated input current for frame size FSE is based on the duty cycle for low overload (LO), regarding the second value, the current is based on the duty cycle for high overload (HO).



## Selection and ordering data

Accessories	
Description	Article No.
<b>RS485 terminating resistor</b>	<b>6SL3255-0VC00-0HA0</b>
Content: 50 units	
<b>DIN rail mounting set</b>	<b>6SL3261-1BA00-0AA0</b>
<ul style="list-style-type: none"> <li>For frame sizes FSAA, FSAB, FSAC, FSAD, and FSA</li> <li>For frame sizes FSAA, FSAB, FSAC, and FSAD, a migration mounting set is also required for installation</li> <li>For frame size FSA with fan, the operating instructions must be followed for assembly</li> </ul>	
<ul style="list-style-type: none"> <li>For frame size FSB</li> </ul>	<b>6SL3261-1BB00-0AA0</b>
<b>Migration mounting set</b>	<b>6SL3266-1ER00-0VA0</b> <b>6SL3266-1EB00-0VA0</b> <b>6SL3266-1EV00-0VA0</b>
Required in addition to the DIN rail mounting set for installing frame sizes FSAA, FSAB, FSAC, and FSAD	
<ul style="list-style-type: none"> <li>For frame sizes FSAA and FSAB</li> <li>For frame size FSAC</li> <li>For frame size FSAD</li> </ul>	

## Technical specifications

	SINAMICS V20
<b>Power range</b>	230 V 1 AC: 0.12 ... 3 kW (0.16 ... 4 hp) 400 V 3 AC: 0.37 ... 30 kW (0.5 ... 40 hp)
<b>Offset factor <math>\cos \varphi</math></b>	$\geq 0.95$
<b>Power factor <math>\lambda</math></b>	0.72
<b>Line voltage</b>	230 V 1 AC: 200 ... 240 V 1 AC (-15 ... +10 %) <sup>1)</sup> 400 V 3 AC: 380 ... 480 V 3 AC (-15 ... +10 %)
<b>Maximum output voltage</b>	100 % of input voltage
<b>Line frequency</b>	50 Hz/60 Hz
<b>Line system configuration</b>	<ul style="list-style-type: none"> <li>TN, TT, TT grounded line supply</li> <li>IT for               <ul style="list-style-type: none"> <li>230 V 1 AC unfiltered devices, frame sizes FSAA, FSAB, FSAC, and FSAD</li> <li>400 V 3 AC unfiltered devices</li> </ul> </li> </ul>
<b>Overload capability</b>	<ul style="list-style-type: none"> <li>Up to 15 kW</li> <li>From 18.5 kW</li> </ul> High overload (HO): 150 % $I_H$ for 60 s within a cycle time of 300 s. Low overload (LO): 110 % $I_L$ for 60 s within a cycle time of 300 s. High overload (HO): 150 % $I_H$ for 60 s within a cycle time of 300 s.
<b>Output frequency</b>	0 ... 550 Hz, resolution: 0.01 Hz
<b>Pulse frequency</b>	2 ... 16 kHz
<b>Efficiency acc. to IEC 61800-9-2</b>	95 ... 98 %
<b>Efficiency class acc. to IEC 61800-9-2</b>	IE2
<b>Programmable fixed frequency setpoints</b>	16
<b>Analog inputs</b>	AI1: bipolar current/voltage mode AI2: unipolar current/voltage mode can be used as digital inputs
<ul style="list-style-type: none"> <li>Resolution</li> </ul>	12 bit
<b>Analog output</b>	AO1 current output 0 ... 20 mA
<b>Digital inputs</b>	DI1 ... DI4: isolated; for 400 V converters with optional SINAMICS V20 I/O Extension Module two additional digital inputs DI5 and DI6 PNP/NPN selectable via terminal
<ul style="list-style-type: none"> <li>Input current, max.</li> </ul>	15 mA
<b>Digital outputs</b>	DO1: transistor output DO2: relay output; for 400 V converters with optional SINAMICS V20 I/O Extension Module two additional digital outputs (relay outputs) DO3 and DO4 250 V AC 0.5 A with resistive load 30 V DC 0.5 A with resistive load
<b>Integrated interface</b>	
<ul style="list-style-type: none"> <li>Type</li> <li>Protocols</li> </ul>	RS485 USS, Modbus RTU
<b>Extension interface</b>	SINAMICS V20 BOP Interface, SINAMICS V20 Smart Access, SINAMICS V20 Parameter Loader, SINAMICS V20 I/O Extension Module (cannot be operated simultaneously with SINAMICS V20 Parameter Loader)

<sup>1)</sup> Single-phase devices can also be connected to two phases of a 3-phase 230 V power supply system. You can find detailed information here: <https://support.industry.siemens.com/cs/document/109476260>

## SINAMICS V20 basic converters

0.12 kW to 30 kW (0.16 hp to 40 hp)

### SINAMICS V20 basic converters

#### Technical specifications

SINAMICS V20	
<b>Control methods</b>	
• V/f linear/square/multi-point	✓
• V/f with flux current control (FCC)	✓
<b>Functions</b>	
<b>Easy to use</b>	
Automatic restart	✓
Parameter cloning	✓
Drive data sets (DDS)	✓ (3)
Command data sets (CDS)	✓ (3)
JOG	✓
Pre-configured connection macros and application macros	✓
Simple parameter-based menu on internal or external SINAMICS V20 BOP	✓
Simple text menu for setup	✓
USS	✓
Modbus RTU	✓
Motor frequency display scaling	✓
Customization of parameter defaults	✓
Energy consumption monitoring	✓
List of modified parameters	✓
Converter status in case of a fault	✓
<b>Application</b>	
Keep Running Mode	✓
Flying restart	✓
PID controller	✓
Kinetic buffering ( $V_{dc\_min}$ controller)	✓
Skippable frequency bandwidth	4
<b>Braking functions</b>	
• DC braking	✓
• Compound braking	✓
• Dynamic braking	✓
2-wire/3-wire control	✓
Mechanical holding brake control	✓
Super torque mode	✓
Hammer start mode	✓
Blockage clearing mode	✓
Hibernation mode	✓
Motor staging	✓
Multi-pump control <sup>1)</sup> for 400 V converters with optional SINAMICS V20 I/O Extension Module)	✓
Dual ramp parameterizable	✓
Wobble function	✓
BICO function	✓
Slip compensation	✓

SINAMICS V20	
<b>Functions (continued)</b>	
<b>Protection</b>	
DC link voltage control	✓
Load torque monitoring	✓
Phase loss detection	✓
Cavitation protection	✓
Condensation protection	✓
Frost protection	✓
<b>Control</b>	
ECO mode	✓
$V_{dc\_max}$ controller	✓
$I_{max}$ controller	✓
Programmable V/f coordinates	✓
Flexible voltage boost	✓
50/60 Hz adaptation	✓

<sup>1)</sup> Further information on the multi-pump control can be found in the operating instructions and on the internet at:  
[www.siemens.com/sinamics-v20/documentation](http://www.siemens.com/sinamics-v20/documentation)

## Technical specifications

SINAMICS V20	
<b>General technical specifications</b>	
<b>Degree of protection</b>	IP20
<b>Mounting</b>	Wall mounting, side-by-side mounting, push-through mounting for FSB, FSC, FSD, and FSE
<b>Ambient temperature</b>	
• Operation	-10 ... +40 °C (14 ... 104 °F) without derating 40 ... 60 °C (104 ... 140 °F) with derating
• Storage	-40 ... +70 °C (-40 ... +158 °F)
<b>Relative humidity</b>	95 % (non-condensing)
<b>Cooling</b>	
• FSAA, FSAB, FSA up to 0.75 kW	Convection cooling
• FSAC, FSAD, FSA, FSB, FSC, FSD, FSE	Power electronics cooled using heat sinks with external fan
<b>Installation altitude</b>	Up to 4000 m (13124 ft) above sea level 1000 ... 4000 m: (3281 ... 13124 ft): output current derating 2000 ... 4000 m (6562 ... 13124 ft): input voltage derating
<b>Motor cable length</b>	
• Unshielded	
- FSAA to FSD	50 m (164 ft)
- FSE	100 m (328 ft)
• Shielded	
- FSAA to FSD	25 m (82 ft)
- FSE	50 m (164 ft)
• Longer motor cables with an additional output reactor	
- 230 V 1 AC	200 m (656 ft) (shielded and unshielded)
- 400 V 3 AC	150 m (492 ft) (shielded and unshielded) for frame sizes FSA to FSD 200/300 m (656 ft/984 ft) (shielded/unshielded) for frame size FSE
<b>Vibration load</b>	
• Transport	5 ... 9 Hz: Deflection, 3.5 mm 9 ... 200 Hz: Vibration 1 × <i>g</i> Vibration class: 2M3
• Operation	Area of application IIa 10 ... 58 Hz: Deflection, 0.075 mm 58 ... 200 Hz: Vibration 1 × <i>g</i>
<b>Shock load</b>	
• Operation	Area of application II Peak acceleration: 5 × <i>g</i> Duration of shock: 30 ms

## SINAMICS V20 basic converters

0.12 kW to 30 kW (0.16 hp to 40 hp)

### SINAMICS V20 basic converters

#### Technical specifications

SINAMICS V20										
General technical specifications (continued)										
	FSAA without fan	FSAB without fan	FSAC with 1 fan	FSAD with 1 fan	FSA without fan	FSA with 1 fan	FSB with 1 fan	FSC with 1 fan	FSD with 2 fans	FSE with 2 fans
<b>Dimensions</b>										
• Width in mm (in)	68 (2.68)	68 (2.68)	90.8 (3.57)	136.6 (5.38)	90 (3.54)	90 (3.54)	140 (5.51)	184 (7.24)	240 (9.45)	245 (9.65)
• Height in mm (in)	142 (5.59)	142 (5.59)	160.9 (6.33)	176.5 (6.95)	150 (5.91)	166 (6.54)	160 (6.3)	182 (7.17)	206.5 (8.13)	264.5 (10.41)
• Depth in mm (in)	107.8 (4.24)	127.8 (5.03)	147 (5.79)	158.8 (6.25)	145.5 (5.73)	145.5 (5.73)	164.5 (6.48)	169 (6.65)	172.5 (6.79)	209 (8.23)
<b>Weight, approx.</b>										
• 230 V 1 AC										
- Without integrated line filter	0.6 kg (1.32 lb)	0.8 kg (1.76 lb)	1.2 kg (2.65 lb)	1.9 kg (4.19 lb)	–	–	–	–	–	–
- With integrated line filter category C1	0.7 kg (1.54 lb)	0.9 kg (1.98 lb)	1.4 kg (3.09 lb)	2.2 kg (4.85 lb)	–	–	–	–	–	–
• 400 V 3 AC										
- Without integrated line filter	–	–	–	–	0.9 kg (1.98 lb)	1 kg (2.21 lb)	1.6 kg (3.53 lb)	2.4 kg (5.29 lb)	3.9 kg (8.60 lb)	6.4 kg (14.1 lb)
- With integrated line filter category C3	–	–	–	–	1 kg (2.21 lb)	1.1 kg (2.43 lb)	1.8 kg (3.97 lb)	2.6 kg (5.73 lb)	4.3 kg (9.48 lb)	7 kg (15.4 lb)
<b>Mounting clearance, min.</b>										
• Top	100 mm (3.94 in)									
• Bottom	100 mm (3.94 in) 85 mm (3.35 in) for fan-cooled FSA									
• Side	0 mm									
<b>Certificates of suitability</b>										
cULus, CE, UKCA, RCM, KC										
<b>Environmental classes</b>										
Pollution class: 3S2 Gas class: 3C2 (SO <sub>2</sub> , H <sub>2</sub> S) Climate class: 3K3										
<b>CE marking, according to</b>										
European Low Voltage Directive (EN 61800-5-1/EN 60204-1), Eco-design requirements of EU Directive 2019/1781 and European EMC Directive (EN 61800-3)										
<b>UL marking, according to</b>										
UL508C										
<b>EMC standards, radiated emissions and disturbance voltage (conducted emissions)</b>										
• EN 61800-3 category C1, 1st environment (residential, commercial)	<ul style="list-style-type: none"> <li>• 230 V 1 AC with integrated line filter or unfiltered with external line filter, shielded cables               <ul style="list-style-type: none"> <li>- FSAA, FSAB, and FSAD: ≤5 m (16.4 ft)</li> <li>- FSAC: ≤10 m (32.8 ft)</li> </ul> </li> </ul>									
• EN 61800-3 category C2, 1st environment (residential, commercial)	<ul style="list-style-type: none"> <li>• 400 V 3 AC without integrated line filter, with external line filter, shielded cables               <ul style="list-style-type: none"> <li>- FSA<sup>1)</sup> to FSE ≤25 m (82 ft)</li> </ul> </li> </ul>									
• EN 61800-3 category C3, 2nd environment (industrial)	<ul style="list-style-type: none"> <li>• 400 V 3 AC with integrated line filter, shielded cables               <ul style="list-style-type: none"> <li>- FSA: ≤10 m (32.8 ft)</li> <li>- FSB to FSD: ≤25 m (82 ft)</li> <li>- FSE: ≤50 m (164 ft)</li> </ul> </li> </ul>									
<b>Note</b>										
The EMC product standard EN 61800-3 does not apply directly to a frequency converter but to a PDS (Power Drive System), which covers the complete circuitry, motor and cables in addition to the converter. The converters themselves are in general not subject to marking in accordance with the EMC directive.										

<sup>1)</sup> To achieve 25 m (82 ft) shielded motor cable lengths with FSA frame size converters, unfiltered converters with external line filters have to be used.

## SINAMICS V20 basic converters

0.12 kW to 30 kW (0.16 hp to 40 hp)

### SINAMICS V20 basic converters

#### Dimensional drawings

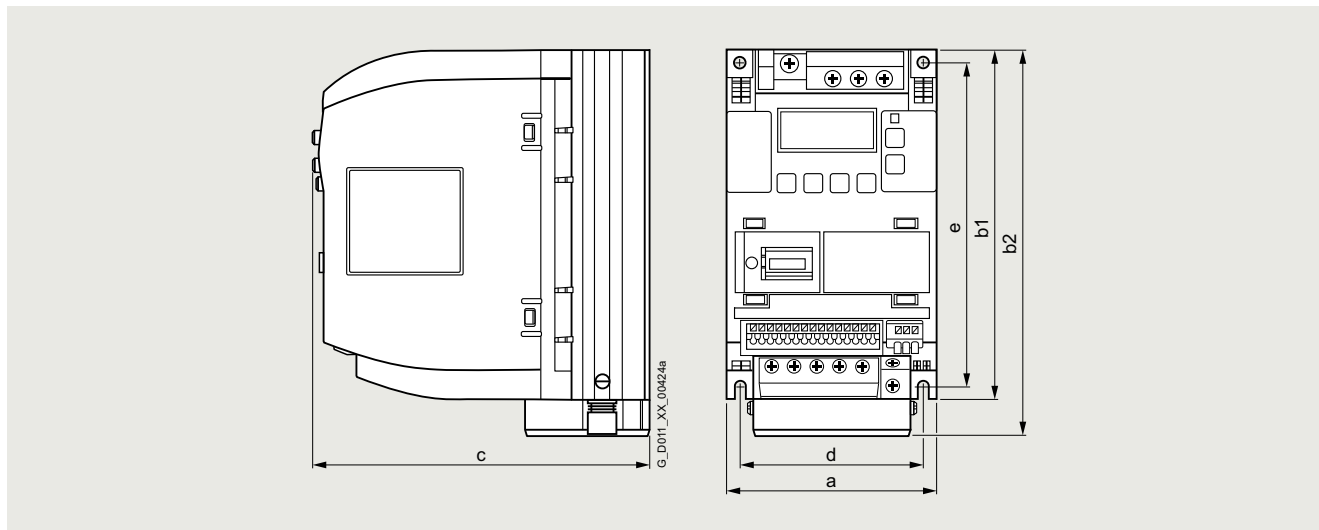

Frame size	Dimensions in mm (inches)				Drilling dimensions in mm (inches)	
	a (width)	b1 (height) without fan	b2 (height) with fan	c (depth)	d	e
FSAA	68 (2.68)	142 (5.59)	–	107.8 (4.24)	58 (2.28)	132 (5.2)
FSAB	68 (2.68)	142 (5.59)	–	127.8 (5.03)	58 (2.28)	132 (5.2)
FSAC	90.8 (3.57)	–	160.9 (6.33)	147 (5.79)	79 (3.11)	140 (5.51)
FSAD	136.6 (5.38)	–	176.5 (6.95)	158.8 (6.25)	122 (4.8)	159 (6.26)
FSA	90 (3.54)	150 (5.91)	166 (6.54)	145.5 (5.73)	79 (3.11)	140 (5.51)
FSB	140 (5.51)	–	160 (6.3)	164.5 (6.48)	127 (5)	135 (5.31)
FSC	184 (7.24)	–	182 (7.17)	169 (6.65)	170 (6.69)	140 (5.51)
FSD	240 (9.45)	–	206.5 (8.13)	172.5 (6.79)	223 (8.78)	166 (6.54)
FSE	245 (9.65)	–	264.5 (10.41)	209 (8.23)	228 (8.98)	206 (8.11)

Frame size	Mounting clearance, min. in mm (inches)		
	Top	Bottom	Side
FSAA, FSAB, FSAC, FSAD	100 (3.94)	100 (3.94)	0
FSA without fan	100 (3.94)	100 (3.94)	0
FSA with fan	100 (3.94)	85 (3.35)	0
FSB to FSE	100 (3.94)	100 (3.94)	0

#### More information

##### Identification link according to IEC 61406 for SINAMICS V20

The ID link contains the article and serial number of the product. As a QR code, it replaces the previous data matrix code on the nameplate and takes you with the URL directly to a product information page on the internet with access to the technical documentation, data sheet, certificates, FAQs, product notifications, and catalogs. Paper package inserts become superfluous since the information is available electronically directly via the QR code, even years later. In this way, we are making a valuable contribution to the preservation of our environment. You don't need an additional app. Simply scan the QR code with your smartphone or tablet. According to IEC 61406, the QR code of an ID link is marked with a frame and a triangle at the bottom right.

With their globally unique identifiers, Siemens products are ready for Industry 4.0.

The ID serves as a connection to the administration shell with which modules of the digital twin can be provided.

Detailed information on SINAMICS V20, the latest technical documentation (brochures, dimensional drawings, certificates, manuals and operating instructions) is available on the internet at:

[www.siemens.com/sinamics-v20](http://www.siemens.com/sinamics-v20)

In addition, the Siemens Product Configurator can be used on the internet. The Siemens Product Configurator can be found in the Siemens Industry Mall at the following address:

[www.siemens.com/spc](http://www.siemens.com/spc)

Furthermore, the SINAMICS SELECTOR app is a practical tool that helps you find article numbers for SINAMICS V20, SINAMICS V90, SINAMICS G120C, SINAMICS G120P, SINAMICS G120X, SINAMICS G120 and SINAMICS S210 converters in the output range from 0.1 kW to 630 kW quickly and easily. You will find free downloads for Android and iOS here: [www.siemens.com/sinamics-selector](http://www.siemens.com/sinamics-selector)

## SINAMICS V20 basic converters

0.12 kW to 30 kW (0.16 hp to 40 hp)

### SINAMICS V20 starter kit

#### Overview



#### SINAMICS V20 starter kit

A SINAMICS V20 starter kit comprises the following components:

- SINAMICS V20 converter (230 V 1 AC with integrated filter, frame size FSAA, 0.37 kW)
- SINAMICS V20 BOP (Basic Operator Panel)
- SINAMICS V20 BOP Interface
- SINAMICS V20 Parameter Loader
- SINAMICS V20 Smart Access

The delivery quantity is limited to three units per customer.

#### Selection and ordering data

Description	Article No.
<b>SINAMICS V20 starter kit</b>	<b>6SL3200-0AE50-0AA0</b>

**Overview**

Line filter for frame size FSA

230 V converters without integrated line filters can satisfy EN 61800-3 category C1 with the specified line filters class B when used with a shielded output cable with a maximum length of 5 m for frame sizes FSAA, FSAB, and FSAD, and 10 m for frame size FSAC.

400 V converters with or without integrated line filters can satisfy EN 61800-3 category C2 with the specified line filters class B if they are used with a shielded output cable with a maximum length of 25 m.

**SINAMICS V20 basic converters**

0.12 kW to 30 kW (0.16 hp to 40 hp)

**Line-side components > Line filters****Selection and ordering data**

Rated power		SINAMICS V20		Line filter class B for category C1, shielded motor cable length max. 5 m (FSAA and FSAB) max. 10 m (FSAC)
kW	hp	6SL3210-	Frame size	Article No.
<b>200 ... 240 V 1 AC</b>				
0.12	0.16	5BB11-2UV1	FSA	Siemens recommendation: Line filter TDK Electronics AG type TDK B84713H0020B193 or similar
0.25	0.33	5BB12-5UV1	FSA	
0.37	0.5	5BB13-7UV1	FSA	
0.55	0.75	5BB15-5UV1	FSAB	
0.75	1	5BB17-5UV1	FSAB	
1.1	1.5	5BB21-1UV1	FSAC	
1.5	2	5BB21-5UV1	FSAC	Siemens recommendation: Line filter Schaffner type FS41095-30-44 or similar
2.2	3	5BB22-2UV1	FSAD	
3	4	5BB23-0UV1	FSAD	

Rated power		SINAMICS V20		Line filter class B for category C2, shielded motor cable length max. 25 m
kW	hp	6SL3210-	Frame size	Article No.
<b>380 ... 480 V 3 AC</b>				
0.37	0.5	5BE13-7UV0	FSA	<b>6SL3203-0BE17-7BA0</b>
0.55	0.75	5BE15-5UV0	FSA	
0.75	1	5BE17-5UV0	FSA	
1.1	1.5	5BE21-1UV0	FSA	
1.5	2	5BE21-5UV0	FSA	
2.2	3	5BE22-2UV0	FSA	
3	4	5BE23-0UV0	FSB	<b>6SL3203-0BE21-8BA0</b>
4	5	5BE24-0UV0	FSB	
5.5	7.5	5BE25-5UV0	FSC	<b>6SL3203-0BE23-8BA0</b>
7.5	10	5BE27-5UV0	FSD	
11	15	5BE31-1UV0	FSD	
15	20	5BE31-5UV0	FSD	<b>6SL3203-0BE27-5BA0</b>
22	30	5BE31-8UV0	FSE	
30	40	5BE32-2UV0	FSE	



## SINAMICS V20 basic converters

0.12 kW to 30 kW (0.16 hp to 40 hp)

Line-side components > Line filters

### Technical specifications

Line voltage 380 ... 480 V 3 AC		Line filter class B			
		6SL3203-0BE17-7BA0	6SL3203-0BE21-8BA0	6SL3203-0BE23-8BA0	6SL3203-0BE27-5BA0
<b>Rated current</b>	A	11.4	23.5	49.4	72
<b>Line supply connection</b> L1, L2, L3		Screw terminals	Screw terminals	Screw terminals	Screw terminals
• Conductor cross-section	mm <sup>2</sup>	1 ... 2.5	2.5 ... 6	6 ... 16	16 ... 50
<b>Load connection</b> U, V, W		Shielded cable	Shielded cable	Shielded cable	Shielded cable
• Cable cross-section	mm <sup>2</sup>	1.5	4	10	16
• Length	m (ft)	0.45 (1.48)	0.5 (1.64)	0.54 (1.77)	1 (3.28)
<b>PE connection</b>		On housing via M5 screw studs	On housing via M5 screw studs	On housing via M6 screw studs	On housing via M6 screw studs
• Conductor cross-section	mm <sup>2</sup>	1 ... 2.5	1.5 ... 6	6 ... 16	16 ... 50
<b>Degree of protection</b>		IP20	IP20	IP20	IP20
<b>Dimensions</b>					
• Width	mm (in)	73 (2.87)	100 (3.94)	140 (5.51)	100 (3.94)
• Height	mm (in)	202 (7.95)	297 (11.69)	359 (14.13)	400 (15.75)
• Depth	mm (in)	65 (2.56)	85 (3.35)	95 (3.74)	140 (5.51)
<b>Weight, approx.</b>	kg (lb)	1.75 (3.86)	4 (8.82)	7.3 (16.1)	7.6 (16.8)
<b>Suitable for SINAMICS V20</b>	Type	6SL3210-5BE13-7UV0 6SL3210-5BE15-5UV0 6SL3210-5BE17-5UV0 6SL3210-5BE21-1UV0 6SL3210-5BE21-5UV0 6SL3210-5BE22-2UV0 FSA	6SL3210-5BE23-0UV0 6SL3210-5BE24-0UV0 FSB 6SL3210-5BE25-5UV0 FSC	6SL3210-5BE27-5UV0 6SL3210-5BE31-1UV0 6SL3210-5BE31-5UV0 FSD	6SL3210-5BE31-8UV0 6SL3210-5BE32-2UV0 FSE

**SINAMICS V20 basic converters**

0.12 kW to 30 kW (0.16 hp to 40 hp)

Line-side components &gt; Line reactors

**Overview**

Line reactors are used to smooth voltage peaks or to bridge commutating dips. Line reactors also reduce the effects of harmonics on the converter and the line supply.

Line reactors for frame sizes FSA to FSE

**Selection and ordering data**

Rated power		SINAMICS V20		Line reactor
kW	hp	6SL3210-	Frame size	Article No.
<b>200 ... 240 V 1 AC</b>				
0.12	0.16	5BB11-2 . V1	FSAA	<b>6SE6400-3CC00-4AB3</b>
0.25	0.33	5BB12-5 . V1	FSAA	
0.37	0.5	5BB13-7 . V1	FSAA	
0.55	0.75	5BB15-5 . V1	FSAB	<b>6SE6400-3CC01-0AB3</b>
0.75	1	5BB17-5 . V1	FSAB	
1.1	1.5	5BB21-1 . V1	FSAC	<b>6SE6400-3CC02-6BB3</b>
1.5	2	5BB21-5 . V1	FSAC	
2.2	3	5BB22-2 . V1	FSAD	<b>6SE6400-3CC03-5CB3</b>
3	4	5BB23-0 . V1	FSAD	

Rated power		SINAMICS V20		Line reactor
kW	hp	6SL3210-	Frame size	Article No.
<b>380 ... 480 V 3 AC</b>				
0.37	0.5	5BE13-7 . V0	FSA	<b>6SL3203-0CE13-2AA0</b>
0.55	0.75	5BE15-5 . V0	FSA	
0.75	1	5BE17-5 . V0	FSA	
1.1	1.5	5BE21-1 . V0	FSA	<b>6SL3203-0CE21-0AA0</b>
1.5	2	5BE21-5 . V0	FSA	
2.2	3	5BE22-2 . V0	FSA	<b>6SL3203-0CE21-8AA0</b>
3	4	5BE23-0 . V0	FSB	
4	5	5BE24-0 . V0	FSB	<b>6SL3203-0CE21-8AA0</b>
5.5	7.5	5BE25-5 . V0	FSC	
7.5	10	5BE27-5 . V0	FSD	<b>6SL3203-0CE23-8AA0</b>
11	15	5BE31-1 . V0	FSD	
15	20	5BE31-5 . V0	FSD	<b>6SL3203-0CJ24-5AA0</b>
22	30	5BE31-8 . V0	FSE	
30	40	5BE32-2 . V0	FSE	<b>6SL3203-0CD25-3AA0</b>

## SINAMICS V20 basic converters

0.12 kW to 30 kW (0.16 hp to 40 hp)

Line-side components > Line reactors

### Technical specifications

Line voltage 200 ... 240 V 1 AC		Line reactor			
		6SE6400-3CC00-4AB3	6SE6400-3CC01-0AB3	6SE6400-3CC02-6BB3	6SE6400-3CC03-5CB3
<b>Rated current</b>	A	3.4	8.1	22.8	29.5
<b>Line supply/load connection</b>		Screw terminals	Screw terminals	Screw terminals	Screw terminals
• Conductor cross-section	mm <sup>2</sup>	1 ... 2.5	1 ... 2.5	1.5 ... 6	2.5 ... 10
<b>PE connection</b>		M5 stud bolts	M5 stud bolts	M5 stud bolts	M5 stud bolts
<b>Degree of protection</b>		IP20	IP20	IP20	IP20
<b>Dimensions</b>					
• Width	mm (in)	75.5 (2.97)	75.5 (2.97)	150 (5.91)	185 (7.28)
• Height	mm (in)	200 (7.87)	200 (7.87)	213 (8.39)	245 (9.65)
• Depth	mm (in)	50 (1.97)	50 (1.97)	50 (1.97)	50 (1.97)
<b>Weight, approx.</b>	kg (lb)	0.5 (1.10)	0.5 (1.10)	1.2 (2.65)	3.05 (6.73)
<b>Suitable for SINAMICS V20</b>	Type	6SL3210-5BB11-2 . V1 6SL3210-5BB12-5 . V1 FSAA	6SL3210-5BB13-7 . V1 FSAA 6SL3210-5BB15-5 . V1 6SL3210-5BB17-5 . V1 FSAB	6SL3210-5BB21-1 . V1 6SL3210-5BB21-5 . V1 FSAC	6SL3210-5BB22-2 . V1 6SL3210-5BB23-0 . V1 FSAD

Line voltage 380 ... 480 V 3 AC		Line reactor					
		6SL3203-0CE13-2AA0	6SL3203-0CE21-0AA0	6SL3203-0CE21-8AA0	6SL3203-0CE23-8AA0	6SL3203-0CJ24-5AA0	6SL3203-0CD25-3AA0
<b>Rated current</b>	A	4	11.3	22.3	47	47	63
<b>Power loss</b> at 50/60 Hz	W	23/26	36/40	53/59	88/97	90/115	90/115
<b>Line supply/load connection</b> 1L1, 1L2, 1L3 2L1, 2L2, 2L3		Screw terminals	Screw terminals	Screw terminals	Screw terminals	Screw terminals	Screw terminals
• Conductor cross-section	mm <sup>2</sup>	4	4	10	16	16	16
<b>PE connection</b>		M4 × 8; U washer; spring lock washer	M4 × 8; U washer; spring lock washer	M5 × 10; U washer; spring lock washer	M5 × 10; U washer; spring lock washer	M8 screw	M8 screw
<b>Degree of protection</b>		IP20	IP20	IP20	IP20	IP20	IP20
<b>Dimensions</b>							
• Width	mm (in)	125 (4.92)	125 (4.92)	125 (4.92)	190 (7.48)	275 (10.83)	275 (10.83)
• Height	mm (in)	120 (4.72)	140 (5.51)	145 (5.71)	220 (8.66)	455 (17.91)	455 (17.91)
• Depth	mm (in)	71 (2.8)	71 (2.8)	91 (3.58)	91 (3.58)	84 (3.31)	84 (3.31)
<b>Weight, approx.</b>	kg (lb)	1.1 (2.43)	2.1 (4.63)	2.95 (6.5)	7.8 (17.2)	13 (28.7)	13 (28.7)
<b>Suitable for SINAMICS V20</b>	Type	6SL3210-5BE13-7 . V0 6SL3210-5BE15-5 . V0 6SL3210-5BE17-5 . V0 6SL3210-5BE21-1 . V0 FSA	6SL3210-5BE21-5 . V0 6SL3210-5BE22-2 . V0 FSA 6SL3210-5BE23-0 . V0 6SL3210-5BE24-0 . V0 FSB	6SL3210-5BE25-5 . V0 FSC 6SL3210-5BE27-5 . V0 FSD	6SL3210-5BE31-1 . V0 6SL3210-5BE31-5 . V0 FSD	6SL3210-5BE31-8 . V0 FSE	6SL3210-5BE32-2 . V0 FSE

## SINAMICS V20 basic converters

0.12 kW to 30 kW (0.16 hp to 40 hp)

### Line-side components > Recommended line-side overcurrent protection devices

#### Selection and ordering data

Overcurrent protection devices are absolutely necessary for the operation of the converters. The following table lists recommendations for fuses.

- Siemens fuses of type 3NA3 for use in the area of validity of IEC
- UL-listed fuses Class J for use in USA and Canada

Recommendations on further overcurrent protection devices are available at:

<https://support.industry.siemens.com/cs/document/109755266>

The Short Circuit Current Rating (SCCR) according to UL for industrial control panel installations to NEC Article 409 or UL 508A/508C or UL 61800-5-1 is as follows for Class J fuses for

- SINAMICS V20: 65 kA

SCCR and ICC values for combination with further overcurrent protection devices are available at:

<https://support.industry.siemens.com/cs/document/109755266>

#### Notes for installations in Canada:

The converters are intended for line supply systems with overvoltage category III. More information is available in the technical documentation on the internet at:

[www.siemens.com/sinamics-v20/documentation](http://www.siemens.com/sinamics-v20/documentation)

More information about the listed Siemens fuses is available in Catalog LV 10 as well as in the Industry Mall.

Rated power		SINAMICS V20		IEC-compliant Fuse		UL/cUL-compliant Fuse type	
kW	hp	6SL3210-	Frame size	Current A	Article No.	Rated voltage 600 V AC Class	Current A
<b>200 ... 240 V 1 AC</b>							
0.12	0.16	5BB11-2 . V1	FSAA	10	<b>3NA3803</b>	J	15
0.25	0.33	5BB12-5 . V1	FSAA	10	<b>3NA3803</b>	J	15
0.37	0.5	5BB13-7 . V1	FSAA	10	<b>3NA3803</b>	J	15
0.55	0.75	5BB15-5 . V1	FSAB	10	<b>3NA3803</b>	J	15
0.75	1	5BB17-5 . V1	FSAB	16	<b>3NA3805</b>	J	15
1.1	1.5	5BB21-1 . V1	FSAC	20	<b>3NA3807</b>	J	30
1.5	2	5BB21-5 . V1	FSAC	32	<b>3NA3812</b>	J	30
2.2	3	5BB22-2 . V1	FSAD	35	<b>3NA3814</b>	J	50
3	4	5BB23-0 . V1	FSAD	50	<b>3NA3820</b>	J	50
<b>380 ... 480 V 3 AC</b>							
0.37	0.5	5BE13-7 . V0	FSA	6	<b>3NA3801</b>	J	15
0.55	0.75	5BE15-5 . V0	FSA	6	<b>3NA3801</b>	J	15
0.75	1	5BE17-5 . V0	FSA	6	<b>3NA3801</b>	J	15
1.1	1.5	5BE21-1 . V0	FSA	6	<b>3NA3801</b>	J	15
1.5	2	5BE21-5 . V0	FSA	10	<b>3NA3803</b>	J	15
2.2	3	5BE22-2 . V0	FSA	16	<b>3NA3805</b>	J	15
3	4	5BE23-0 . V0	FSB	16	<b>3NA3805</b>	J	20
4	5	5BE24-0 . V0	FSB	20	<b>3NA3807</b>	J	20
5.5	7.5	5BE25-5 . V0	FSC	32	<b>3NA3812</b>	J	20
7.5	10	5BE27-5 . V0	FSD	63	<b>3NA3822</b>	J	60
11	15	5BE31-1 . V0	FSD	63	<b>3NA3822</b>	J	60
15	20	5BE31-5 . V0	FSD	63	<b>3NA3822</b>	J	60
22	30	5BE31-8 . V0	FSE	63	<b>3NA3822</b>	J	80
30	40	5BE32-2 . V0	FSE	80	<b>3NA3824</b>	J	90

## SINAMICS V20 basic converters

0.12 kW to 30 kW (0.16 hp to 40 hp)

DC link components > Braking resistors

### Overview



Braking resistors for frame sizes FSA and FSC

An external braking resistor can be used to dissipate the regenerative energy produced by the motor, thus giving greatly improved braking and deceleration capabilities.

A braking resistor which is required for dynamic braking can be used with all frame sizes of converters. Frame sizes FSD and FSE have an internal braking chopper, allowing you to connect the braking resistor directly to the converter. For frame sizes FSAA to FSC, an additional Braking Module is required for connecting the braking resistor to the converter.

### Selection and ordering data

Rated power		SINAMICS V20		Braking resistor
kW	hp	6SL3210-	Frame size	Article No.
<b>200 ... 240 V 1 AC</b>				
0.12	0.16	5BB11-2 . V1	FSAA	<b>6SE6400-4BC05-0AA0</b>
0.25	0.33	5BB12-5 . V1	FSAA	
0.37	0.5	5BB13-7 . V1	FSAA	
0.55	0.75	5BB15-5 . V1	FSAB	
0.75	1	5BB17-5 . V1	FSAB	<b>JJY:023151720007</b>
1.1	1.5	5BB21-1 . V1	FSAC	
1.5	2	5BB21-5 . V1	FSAC	<b>JJY:023163720018</b>
2.2	3	5BB22-2 . V1	FSAD	
3	4	5BB23-0 . V1	FSAD	
<b>380 ... 480 V 3 AC</b>				
0.37	0.5	5BE13-7 . V0	FSA	<b>6SL3201-0BE14-3AA0</b>
0.55	0.75	5BE15-5 . V0	FSA	
0.75	1	5BE17-5 . V0	FSA	
1.1	1.5	5BE21-1 . V0	FSA	
1.5	2	5BE21-5 . V0	FSA	<b>6SL3201-0BE21-0AA0</b>
2.2	3	5BE22-2 . V0	FSA	
3	4	5BE23-0 . V0	FSB	
4	5	5BE24-0 . V0	FSB	<b>6SL3201-0BE21-8AA0</b>
5.5	7.5	5BE25-5 . V0	FSC	
7.5	10	5BE27-5 . V0	FSD	<b>6SL3201-0BE23-8AA0</b>
11	15	5BE31-1 . V0	FSD	
15	20	5BE31-5 . V0	FSD	
22	30	5BE31-8 . V0	FSE	<b>6SE6400-4BD21-2DA0</b>
30	40	5BE32-2 . V0	FSE	

## SINAMICS V20 basic converters

0.12 kW to 30 kW (0.16 hp to 40 hp)

### DC link components > Braking resistors

#### Technical specifications

DC link voltage 240 ... 360 V DC		Braking resistor		
		6SE6400-4BC05-0AA0	JJY:023151720007	JJY:023163720018
<b>Resistance</b>	Ω	180	68	37
<b>Rated power <math>P_{DB}</math></b> (Continuous braking power)	kW	0.05	0.11	0.2
<b>Peak power <math>P_{max}</math></b>	kW	1	2.2	4
<b>Degree of protection <sup>1)</sup></b>		IP20	IP20	IP20
<b>Power connections</b>		3 × 1.5 mm <sup>2</sup> (shielded)	Cable	Cable
• Length	m (ft)	0.5 (1.64)	–	–
<b>Thermostatic switch (NC contact)</b>			Integrated	Integrated
• Switching capacity		250 V AC/max. 2.5 A	–	–
• Conductor cross-section	mm <sup>2</sup>	0.5 ... 2.5	–	–
<b>Dimensions</b>				
• Width	mm (in)	72 (2.83)	60 (2.36)	60 (2.36)
• Height	mm (in)	230 (9.06)	217 (8.54)	337 (13.27)
• Depth	mm (in)	43.5 (1.71)	30 (1.18)	30 (1.18)
<b>Weight, approx.</b>	kg (lb)	1 (2.21)	0.7 (1.54)	1.1 (2.43)
<b>Certificates of suitability</b>		cURus	–	–
<b>Suitable for SINAMICS V20</b>	Type	6SL3210-5BB11-2 . V1 6SL3210-5BB12-5 . V1 6SL3210-5BB13-7 . V1 FSAA 6SL3210-5BB15-5 . V1 6SL3210-5BB17-5 . V1 FSAB	6SL3210-5BB21-1 . V1 6SL3210-5BB21-5 . V1 FSAC	6SL3210-5BB22-2 . V1 6SL3210-5BB23-0 . V1 FSAD

DC link voltage 510 ... 720 V DC		Braking resistor				
		6SL3201-0BE14-3AA0	6SL3201-0BE21-0AA0	6SL3201-0BE21-8AA0	6SL3201-0BE23-8AA0	6SE6400-4BD21-2DA0
<b>Resistance</b>	Ω	370	140	75	30	27
<b>Rated power <math>P_{DB}</math></b> (Continuous braking power)	kW	0.075	0.2	0.375	0.925	1.2
<b>Peak power <math>P_{max}</math></b>	kW	1.5	4	7.5	18.5	24
<b>Degree of protection <sup>1)</sup></b>		IP20	IP20	IP20	IP20	IP20
<b>Power connections</b>		M4 screw studs	M4 screw studs	M4 screw studs	M4 screw studs	M6 screw studs
<b>Thermostatic switch (NC contact)</b>						
• Switching capacity		250 V AC/ max. 2.5 A	250 V AC/ max. 2.5 A	250 V AC/ max. 2.5 A	250 V AC/ max. 2.5 A	250 V AC/ max. 2.5 A
• Conductor cross-section	mm <sup>2</sup>	0.5 ... 2.5	0.5 ... 2.5	0.5 ... 2.5	0.5 ... 2.5	0.5 ... 2.5
<b>Dimensions</b>						
• Width	mm (in)	105 (4.13)	105 (4.13)	175 (6.89)	250 (9.84)	270 (10.63)
• Height	mm (in)	295 (11.61)	345 (13.58)	345 (13.58)	490 (19.29)	515 (20.28)
• Depth	mm (in)	100 (3.94)	100 (3.94)	100 (3.94)	140 (5.51)	175 (6.89)
<b>Weight, approx.</b>	kg (lb)	1.48 (3.26)	1.8 (3.97)	2.73 (6.02)	6.2 (13.67)	7.4 (16.3)
<b>Certificates of suitability</b>		cURus	cURus	cURus	cURus	cURus
<b>Suitable for SINAMICS V20</b>	Type	6SL3210-5BE13-7 . V0 6SL3210-5BE15-5 . V0 6SL3210-5BE17-5 . V0 6SL3210-5BE21-1 . V0 6SL3210-5BE21-5 . V0 FSA	6SL3210-5BE22-2 . V0 FSA 6SL3210-5BE23-0 . V0 6SL3210-5BE24-0 . V0 FSB	6SL3210-5BE25-5 . V0 FSC 6SL3210-5BE27-5 . V0 FSD	6SL3210-5BE31-1 . V0 6SL3210-5BE31-5 . V0 FSD	6SL3210-5BE31-8 . V0 6SL3210-5BE32-2 . V0 FSE

<sup>1)</sup> With correctly connected load connection cable.

## SINAMICS V20 basic converters

0.12 kW to 30 kW (0.16 hp to 40 hp)

### DC link components > SINAMICS V20 Braking Module

#### Overview



SINAMICS V20 Braking Module

A Braking Module and the matching external braking resistor are required to bring drives to a controlled standstill in the event of a power failure.

The Braking Module is applicable for frame sizes FSAA to FSC only; FSD and FSE already have an integrated braking chopper.

#### Selection and ordering data

Description	Article No.
<b>SINAMICS V20 Braking Module</b>	<b>6SL3201-2AD20-8VA0</b>

#### Technical specifications

	<b>SINAMICS V20 Braking Module</b> 6SL3201-2AD20-8VA0
<b>Maximum power rating</b>	
• 230 V converters	3 kW with 8 A
• 400 V converters	5.5 kW with 7 A
<b>Braking chopper duty cycle, max.</b>	100 %
<b>Cable length, max.</b>	
• Braking Module to converter	1 m (3.28 ft)
• Braking Module to braking resistor	10 m (32.8 ft)
<b>Mounting</b>	Cabinet mounting (4 × M4 screws)
<b>Protective functions</b>	<ul style="list-style-type: none"> <li>• Short-circuit protection</li> <li>• Overtemperature protection</li> </ul>
<b>Dimensions</b>	
• Width	90 mm (3.54 in)
• Height	150 mm (5.91 in)
• Depth	88 mm (3.46 in)
<b>Weight, approx.</b>	0.71 kg (1.57 lb)
<b>Suitable for SINAMICS V20</b>	Frame sizes FSAA, FSAB, FSAC, FSAD, FSA, FSB, FSC

## SINAMICS V20 basic converters

0.12 kW to 30 kW (0.16 hp to 40 hp)

### Load-side power components > Output reactors

#### Overview



Output reactors reduce the voltage stress on the motor windings. At the same time, the capacitive charging/discharging currents, which place an additional load on the power unit when long motor cables are used, are reduced.

Output reactors for frame sizes FSA and FSB

#### Selection and ordering data

Rated power		SINAMICS V20		Output reactor
kW	hp	6SL3210-	Frame size	Article No.
<b>200 ... 240 V 1 AC</b>				
0.12	0.16	5BB11-2 . V1	FSA	<b>6SL3202-0AE16-1CA0</b>
0.25	0.33	5BB12-5 . V1	FSA	
0.37	0.5	5BB13-7 . V1	FSA	
0.55	0.75	5BB15-5 . V1	FSAB	
0.75	1	5BB17-5 . V1	FSAB	
1.1	1.5	5BB21-1 . V1	FSAC	
1.5	2	5BB21-5 . V1	FSAC	<b>6SL3202-0AE18-8CA0</b>
2.2	3	5BB22-2 . V1	FSAD	<b>6SL3202-0AE21-8CA0</b>
3	4	5BB23-0 . V1	FSAD	

Rated power		SINAMICS V20		Output reactor
kW	hp	6SL3210-	Frame size	Article No.
<b>380 ... 480 V 3 AC</b>				
0.37	0.5	5BE13-7 . V0	FSA	<b>6SL3202-0AE16-1CA0</b>
0.55	0.75	5BE15-5 . V0	FSA	
0.75	1	5BE17-5 . V0	FSA	
1.1	1.5	5BE21-1 . V0	FSA	
1.5	2	5BE21-5 . V0	FSA	
2.2	3	5BE22-2 . V0	FSA	
3	4	5BE23-0 . V0	FSB	<b>6SL3202-0AE18-8CA0</b>
4	5	5BE24-0 . V0	FSB	<b>6SL3202-0AE21-8CA0</b>
5.5	7.5	5BE25-5 . V0	FSC	
7.5	10	5BE27-5 . V0	FSD	<b>6SL3202-0AE23-8CA0</b>
11	15	5BE31-1 . V0	FSD	
15	20	5BE31-5 . V0	FSD	
22	30	5BE31-8 . V0	FSE	<b>6SE6400-3TC03-8DD0</b>
30	40	5BE32-2 . V0	FSE	<b>6SE6400-3TC05-4DD0</b>



## SINAMICS V20 basic converters

0.12 kW to 30 kW (0.16 hp to 40 hp)

### Load-side power components > Output reactors

#### Technical specifications

Line voltage 200 ... 240 V 1 AC		Output reactor (for a 4 kHz pulse frequency)		
		6SL3202-0AE16-1CA0	6SL3202-0AE18-8CA0	6SL3202-0AE21-8CA0
<b>Rated current</b>	A	6.1	9	18.5
<b>Power loss, max.</b>	kW	0.09	0.08	0.08
<b>Connection to the Power Module/ motor connection</b>		Screw terminals	Screw terminals	Screw terminals
• Conductor cross-section	mm <sup>2</sup>	4	4	10
<b>PE connection</b>		M4 screw stud	M4 screw stud	M5 screw stud
<b>Cable length, max.</b> between output reactor and motor				
• Shielded	m (ft)	150 (492)	150 (492)	150 (492)
• Unshielded	m (ft)	150 (492)	150 (492)	150 (492)
<b>Dimensions</b>				
• Width	mm (in)	207 (8.15)	207 (8.15)	247 (9.72)
• Height	mm (in)	175 (6.89)	180 (7.09)	215 (8.46)
• Depth	mm (in)	72.5 (2.85)	72.5 (2.85)	100 (3.94)
<b>Degree of protection</b>		IP20	IP20	IP20
<b>Weight, approx.</b>	kg (lb)	3.4 (7.50)	3.9 (8.60)	10.1 (22.3)
<b>Suitable for SINAMICS V20</b>	Type	6SL3210-5BB11-2 . V1 6SL3210-5BB12-5 . V1 6SL3210-5BB13-7 . V1 FSAA 6SL3210-5BB15-5 . V1 6SL3210-5BB17-5 . V1 FSAB 6SL3210-5BB21-1 . V1 FSAC	6SL3210-5BB21-5 . V1 FSAC	6SL3210-5BB22-2 . V1 6SL3210-5BB23-0 . V1 FSAD

Line voltage 380 ... 480 V 3 AC		Output reactor (for a 4 kHz pulse frequency)					
		6SL3202-0AE16-1CA0	6SL3202-0AE18-8CA0	6SL3202-0AE21-8CA0	6SL3202-0AE23-8CA0	6SE6400-3TC03-8DD0	6SE6400-3TC05-4DD0
<b>Rated current</b>	A	6.1	9	18.5	39	45	54
<b>Power loss, max.</b>	kW	0.09	0.08	0.08	0.11	0.2	0.2
<b>Connection to the Power Module/ motor connection</b>		Screw terminals	Screw terminals	Screw terminals	Screw terminals	Flat connector for cable lug	Flat connector for cable lug
• Conductor cross-section	mm <sup>2</sup>	4	4	10	16	M6	M6
<b>PE connection</b>		M4 screw stud	M4 screw stud	M5 screw stud	M5 screw stud	M6 screw	M6 screw
<b>Cable length, max.</b> between output reactor and motor							
• Shielded	m (ft)	150 (492)	150 (492)	150 (492)	150 (492)	200 (656)	200 (656)
• Unshielded	m (ft)	150 (492)	150 (492)	150 (492)	150 (492)	300 (984)	300 (984)
<b>Dimensions</b>							
• Width	mm (in)	207 (8.15)	207 (8.15)	247 (9.72)	257 (10.12)	225 (8.86)	225 (8.86)
• Height	mm (in)	175 (6.89)	180 (7.09)	215 (8.46)	235 (9.25)	210 (8.27)	210 (8.27)
• Depth	mm (in)	72.5 (2.85)	72.5 (2.85)	100 (3.94)	114.7 (4.52)	179 (7.05)	150 (5.91)
<b>Degree of protection</b>		IP20	IP20	IP20	IP20	IP00	IP00
<b>Weight, approx.</b>	kg (lb)	3.4 (7.50)	3.9 (8.60)	10.1 (22.3)	11.2 (24.7)	16.1 (35.5)	10.7 (23.6)
<b>Suitable for SINAMICS V20</b>	Type	6SL3210-5BE13-7 . V0 6SL3210-5BE15-5 . V0 6SL3210-5BE17-5 . V0 6SL3210-5BE21-1 . V0 6SL3210-5BE21-5 . V0 FSA	6SL3210-5BE22-2 . V0 FSA 6SL3210-5BE23-0 . V0 FSB	6SL3210-5BE24-0 . V0 FSB 6SL3210-5BE25-5 . V0 FSC	6SL3210-5BE27-5 . V0 6SL3210-5BE31-1 . V0 6SL3210-5BE31-5 . V0 FSD	6SL3210-5BE31-8 . V0 FSE	6SL3210-5BE32-2 . V0 FSE

## SINAMICS V20 basic converters

0.12 kW to 30 kW (0.16 hp to 40 hp)

### Supplementary system components > SINAMICS V20 Parameter Loader

#### Overview



SINAMICS V20 Parameter Loader

Up to 100 parameter sets with parameter settings can be written from the memory card to the converter or saved from the converter to the memory card without connecting the converter to the line supply.

#### Design

- SD card socket
- 5 V DC socket for connection to an external DC power supply
- Battery supply (2 × AA) integrated  
Enables the SINAMICS V20 Parameter Loader to be operated and data uploaded and downloaded even when mains power is not available. If the converter is being supplied from the mains power, the battery power can be omitted for the SINAMICS V20 Parameter Loader.

#### Function

With the SINAMICS V20 Parameter Loader, parameter sets can be uploaded and downloaded between the converter and an SD card.

#### Integration

The SINAMICS V20 Parameter Loader and the SINAMICS V20 I/O Extension Module cannot be operated simultaneously.

#### Selection and ordering data

Description	Article No.
<b>SINAMICS V20 Parameter Loader</b> For uploading/downloading parameter sets between the converter and an SD card	<b>6SL3255-0VE00-0UA1</b>
Accessories	
<b>SINAMICS SD card</b>	<b>6SL3054-4AG00-2AA0</b>

#### Dimensional drawings

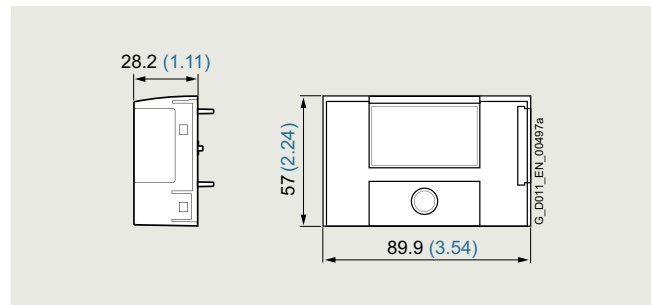

SINAMICS V20 Parameter Loader

All dimensions in mm (values in brackets are in inches).

## SINAMICS V20 basic converters

0.12 kW to 30 kW (0.16 hp to 40 hp)

### Supplementary system components > SINAMICS V20 BOP and SINAMICS V20 BOP Interface

#### Overview



SINAMICS V20 BOP

The SINAMICS V20 supports an external SINAMICS V20 BOP (Basic Operator Panel) for remote control of the converter and is designed for distributed mounting with IP54 and UL Type 1 enclosure rating.



SINAMICS V20 BOP Interface

The SINAMICS V20 BOP Interface is used for connecting the SINAMICS V20 BOP to enable remote control of the converter.

The SINAMICS V20 BOP Interface has an RS232 interface for connecting the SINAMICS V20 BOP to the converter, and a plug connector for connection to the expansion port of the converter.

#### Integration

The SINAMICS V20 BOP is connected to the converter via the optional SINAMICS V20 BOP Interface.

#### Selection and ordering data

Description	Article No.
<b>SINAMICS V20 BOP (Basic Operator Panel)</b> For remote control of the converter To connect the SINAMICS V20 BOP to the converter, the SINAMICS V20 BOP Interface must be ordered together with a network cable with a standard RJ45 connector.	<b>6SL3255-0VA00-4BA1</b>
<b>SINAMICS V20 BOP Interface</b> incl. plug connector for connection to converter The BOP Interface connects the SINAMICS V20 BOP to the converter.	<b>6SL3255-0VA00-2AA1</b>

#### Dimensional drawings

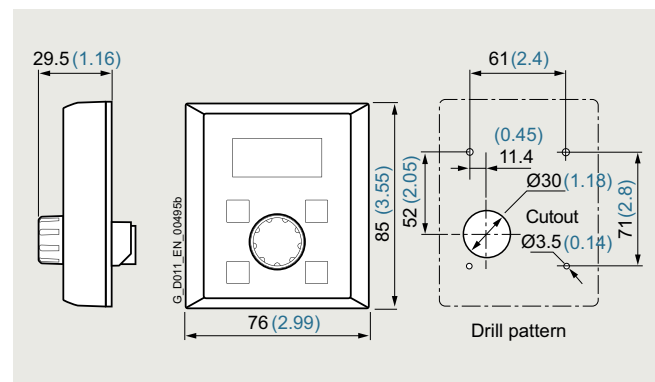

SINAMICS V20 BOP

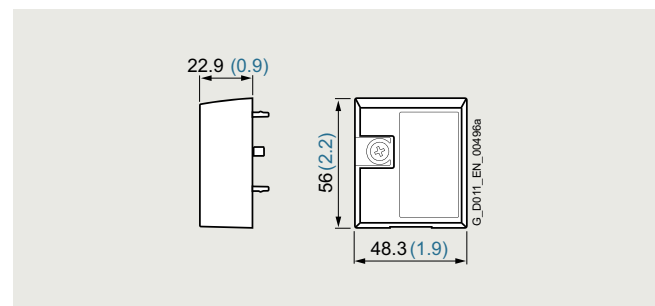

SINAMICS V20 BOP Interface

All dimensions in mm (values in brackets are in inches).

**SINAMICS V20 basic converters**

0.12 kW to 30 kW (0.16 hp to 40 hp)

Supplementary system components &gt; SINAMICS V20 Smart Access

**Overview**

SINAMICS V20 Smart Access

It is also easy and convenient to commission and operate the SINAMICS V20 frequency converter using a smartphone, tablet, or laptop and the web server module SINAMICS V20 Smart Access.

**Function**

- Commissioning using commissioning wizard
- Setting and saving parameters
- Testing motor in JOG mode
- Monitoring of converter data
- Quick diagnostics
- Saving the settings and restoring to factory settings

**Integration**

SINAMICS V20 with Smart Access

The optional SINAMICS V20 Smart Access is simply plugged onto the converter.

**Selection and ordering data**

Description	Article No.
<b>SINAMICS V20 Smart Access</b> For wireless commissioning, operation and diagnostics of the converter using a smartphone, tablet, or laptop	<b>6SL3255-0VA00-5AA0</b>

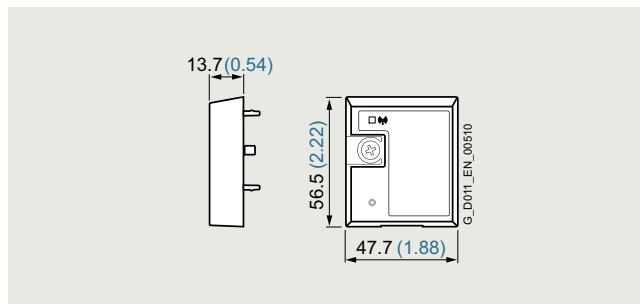
**Dimensional drawings**

SINAMICS V20 Smart Access

All dimensions in mm (values in brackets are in inches).

### Overview



SINAMICS V20 I/O Extension Module

The SINAMICS V20 I/O Extension Module can be directly mounted on the 400 V converters and thus provides two additional digital inputs and two additional digital outputs (relay outputs).

Use of the SINAMICS V20 I/O Extension Module enhances the flexibility of the 400 V converter without additional outlay for installation, hardware and software. This provides additional functionalities such as multi-pump control, with which up to four pumps can be controlled with a frequency converter <sup>1)</sup>.

Typical areas of use are pump, fan and compressor applications or applications that require additional digital inputs and digital outputs.

### Integration



The optional SINAMICS V20 I/O Extension Module is simply plugged onto the converter. Equipped with connections at the front and rear, the SINAMICS V20 I/O Extension Module can be used in combination with other accessories of the SINAMICS V20 converter such as the Smart Access or the BOP and the BOP Interface.

The SINAMICS V20 I/O Extension Module and the SINAMICS V20 Parameter Loader cannot be operated simultaneously.

### Selection and ordering data

Description	Article No.
<b>SINAMICS V20 I/O Extension Module</b> For expansion of the 400 V converters with two digital inputs and two digital outputs (relay outputs)	<b>6SL3256-0VE00-6AA0</b>

### Dimensional drawings

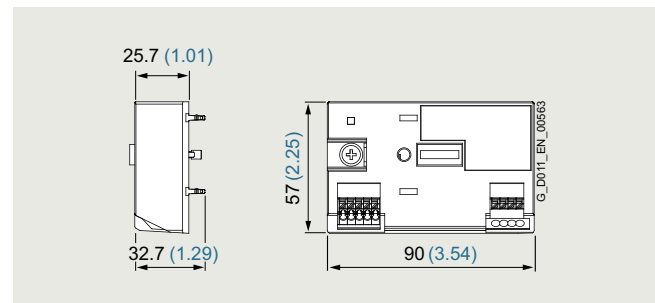

SINAMICS V20 I/O Extension Module

All dimensions in mm (values in brackets are in inches).

<sup>1)</sup> Further information on the multi-pump control can be found in the operating instructions and on the internet at: [www.siemens.com/sinamics-v20/documentation](http://www.siemens.com/sinamics-v20/documentation)

## SINAMICS V20 basic converters

0.12 kW to 30 kW (0.16 hp to 40 hp)

### Supplementary system components > SINAMICS V20 shield connection kits

#### Overview

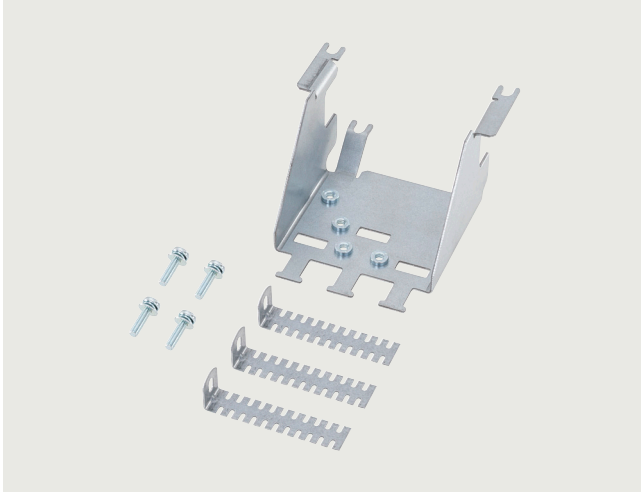

SINAMICS V20 shield connection kit

The shield connection kit offers

- Shield connection
- Strain relief

#### Selection and ordering data

Description	Article No.
<b>SINAMICS V20 shield connection kit</b>	
• For frame sizes FSAA and FSAB	<b>6SL3266-1AR00-0VA0</b>
• For frame size FSAC	<b>6SL3266-1AU00-0VA0</b>
• For frame size FSAD	<b>6SL3266-1AV00-0VA0</b>
• For frame size FSA	<b>6SL3266-1AA00-0VA0</b>
• For frame size FSB	<b>6SL3266-1AB00-0VA0</b>
• For frame size FSC	<b>6SL3266-1AC00-0VA0</b>
• For frame size FSD	<b>6SL3266-1AD00-0VA0</b>
• For frame size FSE	<b>6SL3266-1AE00-0VA0</b>

7

### Supplementary system components > SINAMICS V20 replacement fans

#### Overview



SINAMICS V20 replacement fan for frame size FSA



SINAMICS V20 replacement fans for frame size FSD

The fans are designed for extra long service life. Replacement fans can be ordered.

#### Selection and ordering data

Description	Article No.
<b>SINAMICS V20 replacement fans</b>	
• For frame size FSAC	<b>6SL3200-0UF06-0AA0</b>
• For frame size FSAD	<b>6SL3200-0UF07-0AA0</b>
• For frame size FSA	<b>6SL3200-0UF01-0AA0</b>
• For frame size FSB	<b>6SL3200-0UF02-0AA0</b>
• For frame size FSC	<b>6SL3200-0UF03-0AA0</b>
• For frame size FSD	<b>6SL3200-0UF04-0AA0</b>
• For frame size FSE	<b>6SL3200-0UF05-0AA0</b>

## SINAMICS G120C compact converters 0.55 kW to 132 kW (0.75 hp to 150 hp)



<b>8/2</b>	<b>Introduction</b>
8/2	Application
8/2	More information
<b>8/3</b>	<b>SINAMICS G120C compact converters</b>
8/3	Overview
8/3	Benefits
8/4	Design
8/7	Configuration
8/8	Integration
8/11	Selection and ordering data
8/13	Technical specifications
8/22	Characteristic curves
8/24	Dimensional drawings
8/26	More information
<b>8/27</b>	<b>Line-side components</b>
8/27	Line filters
8/28	Line reactors
8/29	Recommended line-side overcurrent protection devices
<b>8/30</b>	<b>DC link components</b>
8/30	Braking resistors
<b>8/32</b>	<b>Load-side power components</b>
8/32	Output reactors
<b>8/34</b>	<b>Supplementary system components</b>
8/34	Operator panels
8/35	IOP-2 Intelligent Operator Panel
8/38	BOP-2 Basic Operator Panel
8/39	Memory cards
8/40	SINAMICS G120 Smart Access
8/42	PC converter connection kit 2
8/42	Shield connection kits
<b>8/43</b>	<b>Spare parts</b>

# SINAMICS G120C compact converters

0.55 kW to 132 kW (0.75 hp to 150 hp)

## Introduction

## Application

Use	Requirements for torque accuracy/speed accuracy/position accuracy/coordination of axes/functionality					
	Continuous motion			Non-continuous motion		
	Basic	Medium	High	Basic	Medium	High
<b>Pumping, ventilating, compressing</b>	Centrifugal pumps Radial / axial fans Compressors	Centrifugal pumps Radial / axial fans Compressors	Eccentric screw pumps	Hydraulic pumps Metering pumps	Hydraulic pumps Metering pumps	Descaling pumps Hydraulic pumps
	V20 <b>G120C</b> G120X	G120X G130/G150 G180 <sup>1)</sup> DCM	S120	G120	S110	S120
<b>Moving</b>	Conveyor belts Roller conveyors Chain conveyors	Conveyor belts Roller conveyors Chain conveyors Lifting/lowering devices Elevators Escalators/moving walkways Indoor cranes Marine drives Cable railways	Elevators Container cranes Mining hoists Excavators for open-cast mining Test bays	Acceleration conveyors Storage and retrieval machines	Acceleration conveyors Storage and retrieval machines Cross cutters Reel changers	Storage and retrieval machines Robotics Pick & place Rotary indexing tables Cross cutters Roll feeds Engagers/disengagers
	V20 G115D <b>G120C</b> ET 200pro FC-2 <sup>2)</sup>	G120 G120D G130/G150 G180 <sup>1)</sup>	S120 S150 DCM	V90 G120 G120D	S110 S210 DCM	S120 S210 DCM
<b>Processing</b>	Mills Mixers Kneaders Crushers Agitators Centrifuges	Mills Mixers Kneaders Crushers Agitators Centrifuges Extruders Rotary furnaces	Extruders Winders/unwinders Lead/follower drives Calenders Main press drives Printing machines	Tubular bagging machines Single-axis motion control such as • Position profiles • Path profiles	Tubular bagging machines Single-axis motion control such as • Position profiles • Path profiles	Servo presses Rolling mill drives Multi-axis motion control such as • Multi-axis positioning • Cams • Interpolations
	V20 <b>G120C</b>	G120 G130/G150 G180 <sup>1)</sup>	S120 S150 DCM	V90 G120	S110 S210	S120 S210 DCM
<b>Machining</b>	Main drives for • Turning • Milling • Drilling	Main drives for • Drilling • Sawing	Main drives for • Turning • Milling • Drilling • Gear cutting • Grinding	Axis drives for • Turning • Milling • Drilling	Axis drives for • Drilling • Sawing	Axis drives for • Turning • Milling • Drilling • Laser cutting • Gear cutting • Grinding • Nibbling and punching
	S110	S110 S120	S120	S110	S110 S120	S120

SINAMICS G120C compact converters continuously control the speed of three-phase asynchronous (induction) motors and can be used in a wide range of industrial areas. They are generally suitable for applications involving conveyor belts, mixers, extruders, pumps, fans, compressors and basic handling machines.

Practical application examples and descriptions are available on the internet at [www.siemens.com/sinamics-applications](http://www.siemens.com/sinamics-applications)

## More information

You may also be interested in these frequency converters:

- More performance for the control cabinet in IP20 degree of protection ⇒ SINAMICS G120
- Higher degree of protection for power ratings up to 7.5 kW ⇒ SINAMICS G115D, SINAMICS G120D (Catalog D 31.2)
- With positioning function in the control cabinet in IP20 degree of protection ⇒ SINAMICS G120, SINAMICS S110
- With positioning function for distributed drive solutions in IP65 degree of protection ⇒ SINAMICS G120D (Catalog D 31.2)
- For HVAC, water and wastewater applications in the infrastructure sector for power range 0.75 kW to 630 kW ⇒ SINAMICS G120X (Catalog D 31.5)

<sup>1)</sup> Industry-specific converters.

<sup>2)</sup> Information on the SIMATIC ET 200pro FC-2 frequency converter is available in Catalog D 31.2 and at: [www.siemens.com/et200pro-fc](http://www.siemens.com/et200pro-fc)



## SINAMICS G120C compact converters

0.55 kW to 132 kW (0.75 hp to 150 hp)

### SINAMICS G120C compact converters

#### Overview



SINAMICS G120C, frame sizes FSAA to FSF, with Intelligent Operator Panel IOP-2

SINAMICS G120C compact converters offer a well-balanced combination of features to address a wide range of applications. They are compact, rugged devices that are easy to operate and can be optionally equipped with a basic or advanced operator panel.

SINAMICS G120C converters are especially suitable when it comes to meeting the requirements of system integrators, OEMs and distributors regarding high productivity and tailored performance.

#### Benefits

- Compact design
- Frame size FSAA allows easy DIN rail mounting
- Side-by-side design
- High power density, low envelope dimensions
- Simple installation in the tightest space
- Low space requirement
- Use in small control cabinets, close to the machine
- Optimized parameter set
- Optimized commissioning
- Compact Operating Instructions
- BOP-2 or IOP-2 Operator Panels can be used
- Integrated USB connection
- Simple and fast software parameter assignment
- Simple to use during commissioning and in operation
- Minimized training costs, existing SINAMICS know-how can be used
- High degree of service friendliness, simple maintenance
- Plug-in terminals
- Cloning function using BOP-2, IOP-2, or memory card
- Operating hours counter for "drive on" and "motor on"
- Fast mechanical installation
- Intuitive standard commissioning
- Component of Totally Integrated Automation
- Energy-efficient, sensorless vector control
- Automatic flux reduction with V/f ECO
- Integrated energy saving computer
- Safety Integrated (STO)
- Communication versions with PROFINET / EtherNet/IP, PROFIBUS DP, USS/Modbus RTU
- Wireless commissioning, operation and diagnostics via mobile device or laptop thanks to the optional SINAMICS G120 Smart Access
- Varnished modules
- Operation up to an ambient temperature of 60 °C

#### Extended warranty

For SINAMICS G120C, Siemens offers an optional extension of warranty up to 5½ years via **Service Protect**:

- Free for the first 6 months after registering the product at: <https://myregistration.siemens.com>
- Subject to a charge for a further 3 or 5 years

You can find detailed information here:

<https://support.industry.siemens.com/cs/ww/en/sc/4842>

Concerning standard warranty please ask your partner at Siemens. Your partner can be found in our Personal Contacts Database at:

[www.siemens.com/automation-contact](http://www.siemens.com/automation-contact)

## SINAMICS G120C compact converters

0.55 kW to 132 kW (0.75 hp to 150 hp)

### SINAMICS G120C compact converters

#### Design

SINAMICS G120C is a compact converter for control cabinet mounting in IP20 degree of protection where the Control Unit (CU) and Power Module (PM) function units are combined in one device.

The compact mechanical design and the high power density allow these devices to be installed in machine control enclosures and control cabinets for maximum space utilization. The SINAMICS G120C compact converter can be butt-mounted directly, without derating at temperatures up to 40 °C (104 °F).



SINAMICS G120C, frame size FSAA with BOP-2

SINAMICS G120C can be integrated into the widest range of applications, either using the integrated digital and analog inputs or via the integrated fieldbus interface (available in USS, Modbus RTU, PROFIBUS, PROFINET, EtherNet/IP versions). Especially the product versions with integrated PROFIBUS/PROFINET interface make full integration into the Siemens TIA family possible, therefore allowing the advantages of the seamless TIA product family to be fully utilized. SINAMICS G120C devices are preset in the factory so that they can be immediately connected to PROFIBUS or PROFINET fieldbus systems without parameterization.

Wireless commissioning, operation and diagnostics via mobile device or laptop thanks to the optional web server module SINAMICS G120 Smart Access enabling user-friendly operation and easy access to the converter, even if this is installed in areas difficult to access.

SINAMICS G120C is also equipped with the safety function STO (Safe Torque Off) as standard, which is used to safely stop drives. As a consequence, machine manufacturers can simply comply with current machinery directives with minimum associated costs.

SINAMICS G120C can control asynchronous (induction) motors in the power range from 0.37 kW up to 132 kW (0.5 hp to 200 hp). Reliable and efficient motor operation is achieved by using state-of-the-art IGBT technology combined with vector control. The extensive range of functions integrated in the SINAMICS G120C also offers a high degree of protection for the converter and motor.

# SINAMICS G120C compact converters

0.55 kW to 132 kW (0.75 hp to 150 hp)

## SINAMICS G120C compact converters

### Design

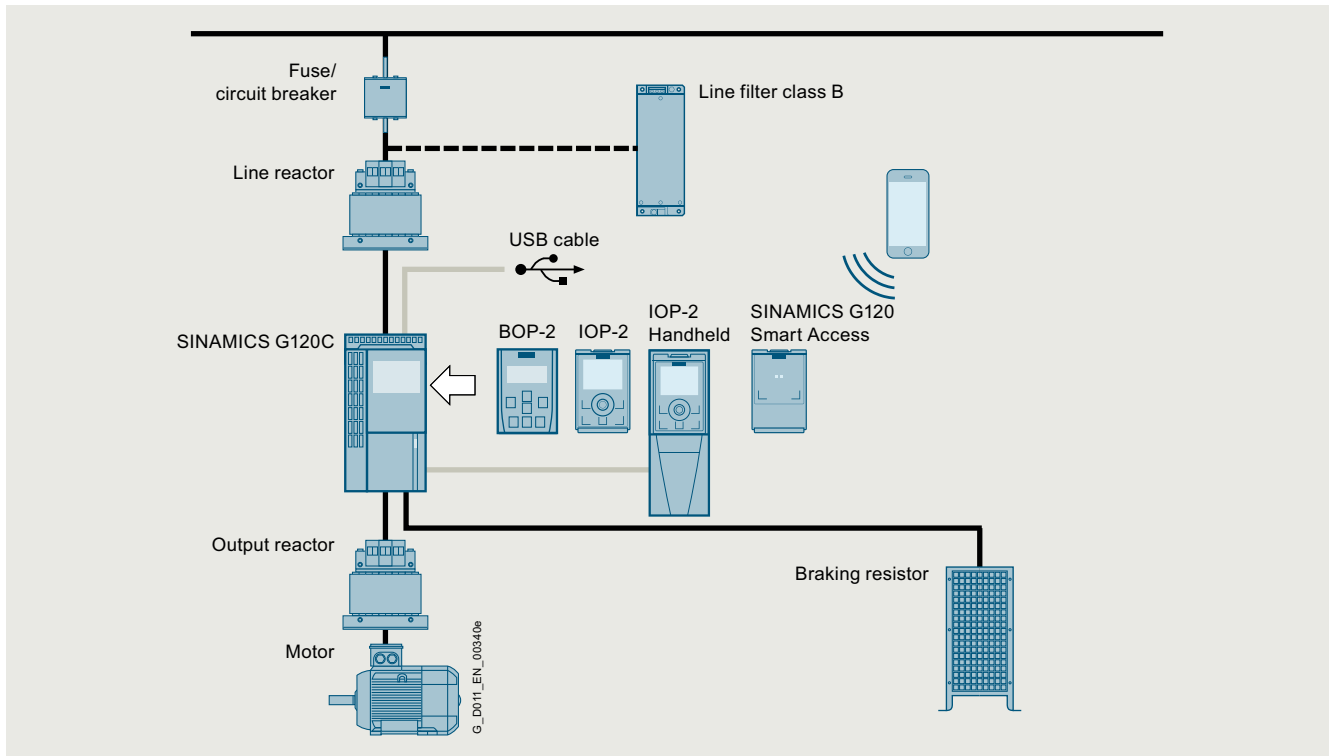

#### Line-side components

##### Line filter

SINAMICS G120C can be ordered with or without integrated Class A line filters. Optionally, an external Class B line filter can be used for classifying in a higher interference class.

##### Line reactors

Line reactors smooth the current drawn by the converter and thus reduce harmonic components in the line current. Through the reduction of the current harmonics, the thermal load on the power components in the rectifier and in the DC link capacitors is reduced as well as the harmonic effects on the supply. The use of a line reactor increases the service life of the converter. A DC link reactor is integrated in frame sizes FSD to FSF, and therefore no line reactor is required.

##### Recommended line-side overcurrent protection devices

Overcurrent protection devices are absolutely necessary for the operation of the converters. The table listed in the section "Recommended line-side overcurrent protection devices" provides recommendations according to IEC and UL regulations, depending on the area of application. Recommendations on further overcurrent protection devices are available at: <https://support.industry.siemens.com/cs/document/109750343>

More information about the listed Siemens fuses is available in Catalog LV 10 as well as in the Industry Mall.

#### DC link components

##### Braking resistors

Excess energy in the DC link is dissipated in the braking resistor. The braking resistors are designed for use with the SINAMICS G120C. This has an integrated braking chopper (electronic switch). For the electromagnetically compatible connection of an optionally connectable braking resistor, the corresponding shield connection kit is to be ordered for frame sizes FSD to FSF.

#### Load-side power components

##### Output reactors

Output reactors reduce the rate of voltage rise (dv/dt) and the height of the current peaks, and enable longer motor cables to be connected.

## SINAMICS G120C compact converters

0.55 kW to 132 kW (0.75 hp to 150 hp)

### SINAMICS G120C compact converters

#### Design

##### **Supplementary system components**

###### IOP-2 Intelligent Operator Panel

Graphics-based, user-friendly and powerful operator panel for commissioning and diagnostics as well as local operator control and monitoring of SINAMICS G120C.

###### BOP-2 Basic Operator Panel

A 2-line display to provide support when commissioning and troubleshooting the drive. The drive can be locally controlled.

###### Memory card

The parameter settings for a converter can be stored on the SINAMICS SD memory card. When service is required, e.g. after the converter has been replaced and the data have been downloaded from the memory card, the drive system is immediately ready for use again. The associated memory card holder is integrated in the converter.

###### SINAMICS G120 Smart Access

Wireless commissioning, operation and diagnostics via mobile device or laptop thanks to the optional web server module SINAMICS G120 Smart Access enabling user-friendly operation and easy access to the converter, even if this is installed in areas difficult to access.

###### PC converter connection kit 2

For controlling and commissioning a converter directly from a PC if the STARTER commissioning tool or SINAMICS Startdrive has been installed on the PC.

###### Shield connection kits

A shield connection kit is included in the scope of delivery for frame sizes FSAA to FSC.

A set of shield plates is included in the scope of delivery for the motor and signal cables corresponding to the frame size for the frame sizes FSD to FSF. For the electromagnetically compatible connection of an optionally connectable braking resistor, the corresponding shield connection kit is to be ordered for frame sizes FSD to FSF.

##### **Additional options**

Further selected accessories are available from "Siemens Product Partner for Drives Options":

[www.siemens.com/drives-options-partner](http://www.siemens.com/drives-options-partner)

##### **Spare parts**

###### Shield connection kits

A shield connection kit is supplied as standard with frame sizes FSAA to FSC. These shield connection kits can also be ordered as spare parts.

A set of shield plates is included in the scope of delivery for the motor and signal cables corresponding to the frame size for the frame sizes FSD to FSF. For the electromagnetically compatible connection of an optionally connectable braking resistor, the corresponding shield connection kit is to be ordered for frame sizes FSD to FSF.

###### Spare parts kit

This kit comprises four I/O terminals, one RS485 terminal, two pairs of Control Unit doors (1 × PN and 1 × other communication versions) and one blanking cover.

###### Set of connectors

A set of connectors for the line feeder cable, braking resistor and motor cable can be ordered corresponding to the frame size of the SINAMICS G120C converter.

###### Roof-mounted fan

A roof-mounted fan (at the top of the device) comprising a pre-assembled unit with holder and fan can be ordered corresponding to the frame size of the SINAMICS G120C.

###### Fan unit

A replacement fan (at the rear of the device; heat sink) comprising a pre-assembled unit with holder and fan can be ordered corresponding to the frame size of the SINAMICS G120C.

## Configuration

The following electronic configuring aids and engineering tools are available for SINAMICS G120C compact converters:

### **SINAMICS DriveSim Basic (firmware V4.7 SP13 or higher)**

SINAMICS DriveSim Basic provides easy-to-use models for PROFIdrive-enabled SINAMICS converters, so you can create a digital twin of your drive.

More information is provided on the internet at:  
<https://support.industry.siemens.com/cs/document/109798225>

### **Siemens Product Configurator**

The Siemens Product Configurator can be used on the internet without requiring any installation. The Siemens Product Configurator can be found in the Siemens Industry Mall at the following address:

[www.siemens.com/spc](http://www.siemens.com/spc)

### **SIZER for Siemens Drives engineering tool (integrated into TIA Selection Tool)**

The SIZER for Siemens Drives engineering tool makes it easy to configure the SINAMICS converter family. It provides support when selecting the hardware and firmware components necessary to implement a drive task. SIZER for Siemens Drives is designed to support configuring of the entire drive system.

You can find further information on the SIZER for Siemens Drives engineering tool in the section [Engineering tools](#).

The SIZER for Siemens Drives engineering tool is available free on the internet at:

[www.siemens.com/sizer](http://www.siemens.com/sizer)

### **STARTER commissioning tool**

The STARTER commissioning tool allows menu-prompted commissioning, optimization and diagnostics as well as the TIA functionality. Apart from the SINAMICS drives, STARTER is also suitable for MICROMASTER 4 devices.

You can find further information on the STARTER commissioning tool in the section [Engineering tools](#).

More information about the STARTER commissioning tool is available on the internet at

[www.siemens.com/starter](http://www.siemens.com/starter)

### **SINAMICS Startdrive commissioning tool**

SINAMICS Startdrive is a tool integrated into the TIA Portal for configuring, commissioning and diagnostics of the SINAMICS converter family. SINAMICS Startdrive (V16 update 4 and higher) can be used to implement converter tasks with most of the SINAMICS G and SINAMICS S converter series. The commissioning tool has been optimized in terms of simplicity, ease of use, and consistent use of the benefits of the TIA Portal to provide a uniform working environment for PLC, HMI and drives.

You can find further information on the SINAMICS Startdrive commissioning tool in the section [Engineering tools](#).

The SINAMICS Startdrive commissioning tool is available free on the internet at:

[www.siemens.com/startdrive](http://www.siemens.com/startdrive)

### **Drive ES engineering system**

Drive ES is the engineering system that can be used to integrate the communication, configuration and data management functions of Siemens drive technology into the SIMATIC automation world easily, efficiently and cost-effectively. The Drive ES PCS software package is available for SINAMICS.

You can find further information on the Drive ES engineering system in the section [Engineering tools](#).

More information about the Drive ES engineering system is available on the internet at

[www.siemens.com/drive-es](http://www.siemens.com/drive-es)

# SINAMICS G120C compact converters

0.55 kW to 132 kW (0.75 hp to 150 hp)

## SINAMICS G120C compact converters

### Integration

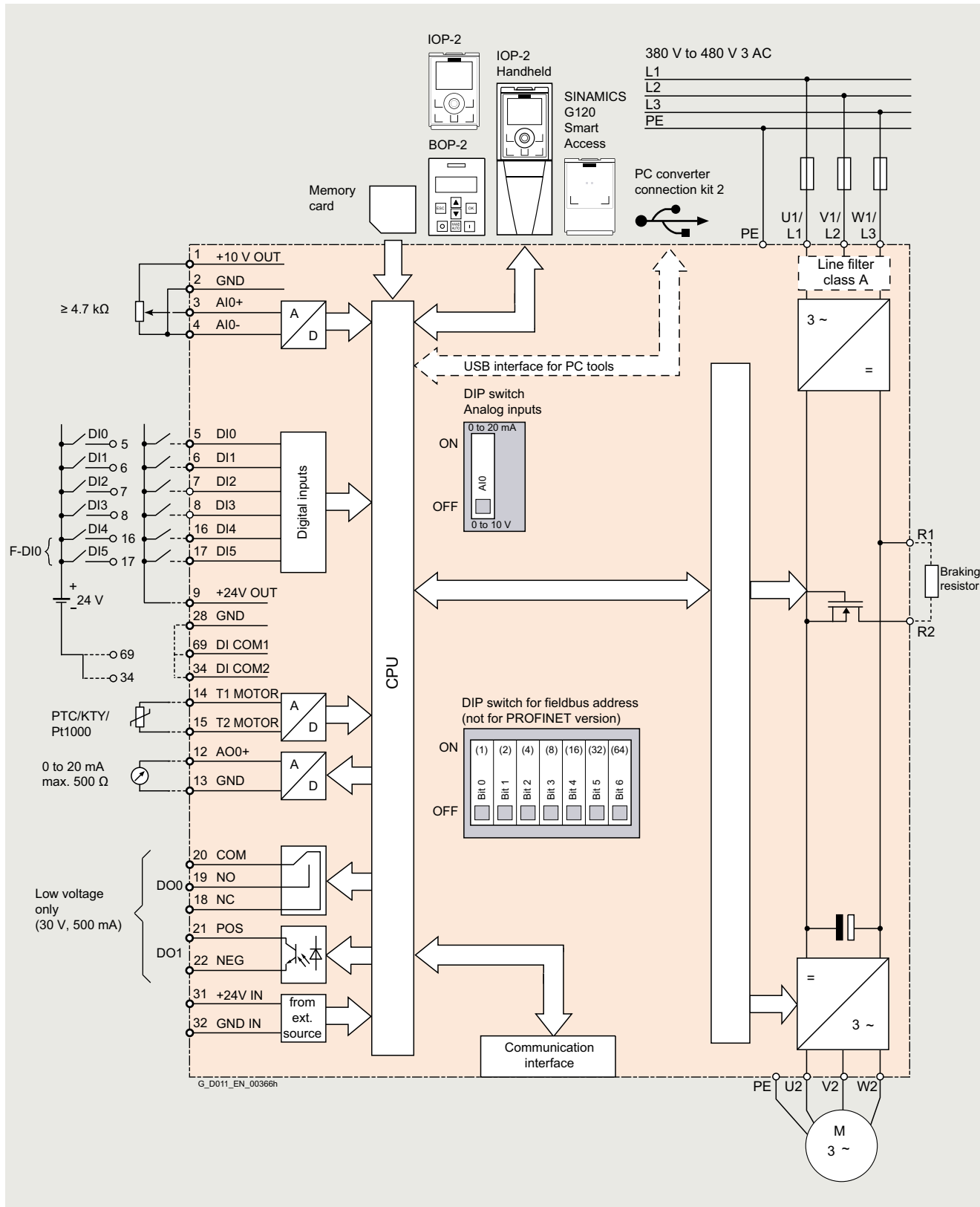

Connection example for SINAMICS G120C

**Integration**

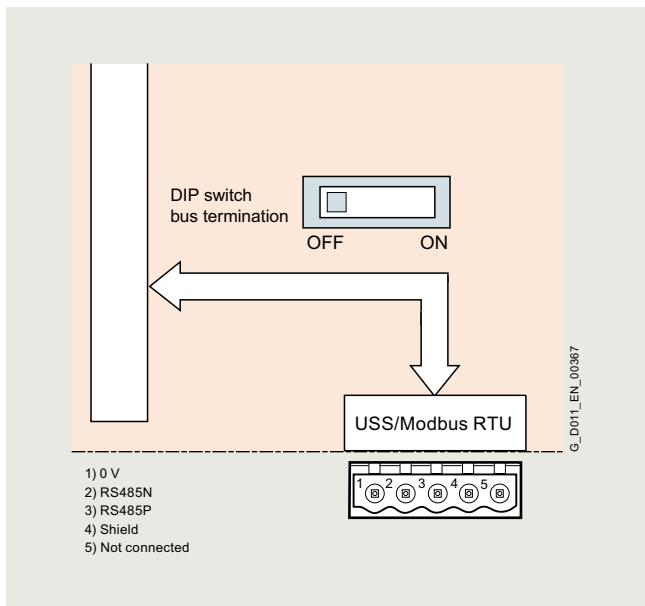

USS/Modbus RTU communication interface

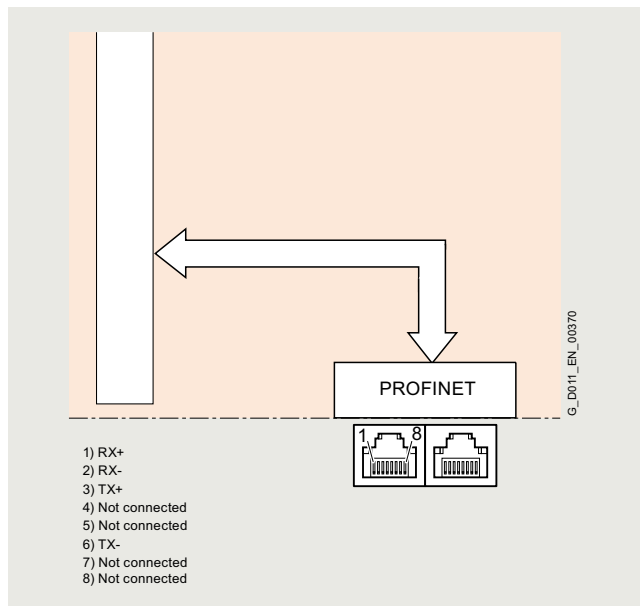

PROFINET, EtherNet/IP communication interface

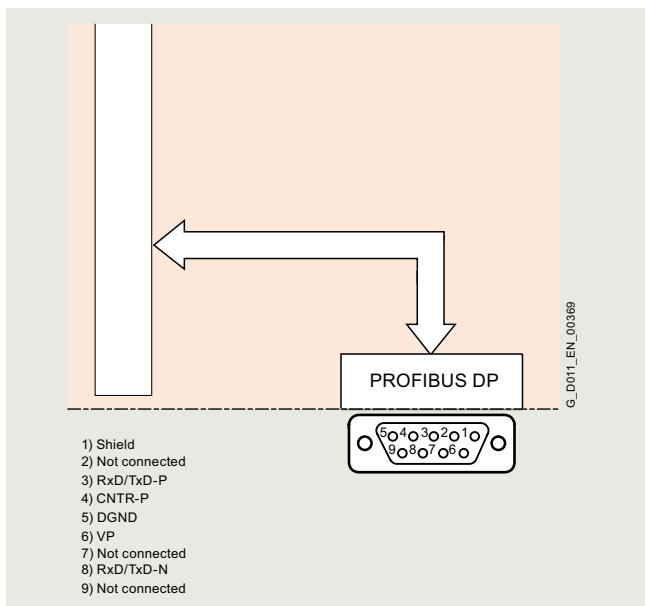

PROFIBUS DP communication interface

## SINAMICS G120C compact converters

0.55 kW to 132 kW (0.75 hp to 150 hp)

### SINAMICS G120C compact converters

#### Integration

##### Available optional power and DC link components

The following line-side components, DC link components and load-side power components are optionally available in the appropriate frame sizes:

	Frame size					
	FSAA, FSA	FSB	FSC	FSD	FSE	FSF
<b>Line-side components</b>						
Line filter class A	F	F	F	F	F	F
Line filter class B	U	U	U	–	–	–
Line reactor	S <sup>1)</sup>	S	S	I	I	I
<b>DC link components</b>						
Braking resistor	S <sup>1)</sup>	S	S	S	S	S
<b>Load-side power components</b>						
Output reactor	S <sup>1)</sup>	S	S	S	S	S

U = Base component

S = Lateral mounting

I = Integrated

F = Converter available with and without integrated filter class A

– = Not possible

##### Maximum permissible cable lengths from the motor to the converter when using output reactors or line filters

The following load-side power components are optionally available in the appropriate frame sizes and result in the following maximum cable lengths, if necessary in combination with line filters for complying with EMC requirements:

	Maximum permissible motor cable lengths (shielded/unshielded) in m (ft)						
	FSAA	FSA	FSB	FSC	FSD	FSE	FSF
<b>Without optional power components</b>							
• Versions without integrated line filter	150 <sup>2)/150</sup> (492 <sup>2)/492)</sup>	150/150 (492/492)	150/150 (492/492)	150/150 (492/492)	200/300 (656/984)	200/300 (656/984)	300/450 (984/1476)
• Versions with integrated line filter class A	50/100 (164/328)	50/100 (164/328)	50/100 (164/328)	50/100 (164/328)	200/300 (656/984)	200/300 (656/984)	300/450 (984/1476)
<b>With optional output reactor</b>							
• At 380 ... 415 V 3 AC	150/225 (492/738)	150/225 (492/738)	150/225 (492/738)	150/225 (492/738)	200/300 (656/984) <sup>5)</sup>	200/300 (656/984) <sup>5)</sup>	300/450 (984/1476) <sup>5)</sup>
• At 440 ... 480 V 3 AC	100/150 (328/492)	100/150 (328/492)	100/150 (328/492)	100/150 (328/492)	200/300 (656/984) <sup>5)</sup>	200/300 (656/984) <sup>5)</sup>	300/450 (984/1476) <sup>5)</sup>
<b>With integrated line filter class A</b> According to EN 55011 to comply with radio interference emissions according to EN 61800-3 EMC Category C2							
	25 <sup>3)/–</sup> (82 <sup>3)/–)</sup>	25 <sup>3)/–</sup> (82 <sup>3)/–)</sup>	25 <sup>3)/–</sup> (82 <sup>3)/–)</sup>	25 <sup>4)/–</sup> (82 <sup>4)/–)</sup>	150/– (492/–)	150/– (492/–)	150/– (492/–)
<b>With optional, external line filter class B</b> According to EN 55011 to comply with cable-conducted radio interference emissions according to EN 61800-3 EMC Category C1 <sup>6)</sup> , together with versions without integrated line filters							
	50/– (164/–)	25/– (82/–)	50/– (164/–)	50/– (164/–)	–	–	–
<b>With optional, external line filter class B and output reactor</b> According to EN 55011 and output reactor to comply with radio interference emissions according to EN 61800-3 EMC Category C2 <sup>6)</sup> , together with versions without integrated line filters							
• At 380 ... 415 V 3 AC	150/– (492/–)	150/– (492/–)	150/– (492/–)	150/– (492/–)	–	–	–
• At 440 ... 480 V 3 AC	100/– (328/–)	100/– (328/–)	100/– (328/–)	100/– (328/–)	–	–	–

<sup>1)</sup> Line reactors, braking resistors and output reactors that are suitable for base mounting are also available for SINAMICS G120C, frame size FSAA, 0.55 kW to 2.2 kW. For 2.2 kW, operation of the line reactor, braking resistor and output reactor that are suitable for base mounting is only permitted for operating the converter with rated power of 1.5 kW based on high overload (HO).  
More information is available in the operating instructions on the internet at: [www.siemens.com/sinamics-g120c/documentation](http://www.siemens.com/sinamics-g120c/documentation)

<sup>2)</sup> For SINAMICS G120C frame size FSAA 2.2 kW with low-capacitance CY cable 150 m (492 ft) (shielded) – otherwise 125 m (410 ft) (shielded).

<sup>3)</sup> With low-capacitance CY cable 50 m (164 ft) (shielded).

<sup>4)</sup> With low-capacitance CY cable 100 m (328 ft) (shielded).

<sup>5)</sup> For frame sizes FSD to FSF the maximum permissible cable lengths are not increased with an output reactor. By means of the output reactor, the loading of the motor windings is reduced by lower rates of voltage rise ( $dv/dt$ ). By means of two output reactors connected in series, the maximum permissible cable lengths for frame sizes FSD and FSE are increased to 350 m (1148 ft) (shielded) and 525 m (1723 ft) (unshielded), and for frame size FSF to 525 m (1723 ft) (shielded) and 800 m (2625 ft) (unshielded).

<sup>6)</sup> More information is available in the operating instructions on the internet at: [www.siemens.com/sinamics-g120c/documentation](http://www.siemens.com/sinamics-g120c/documentation)



# SINAMICS G120C compact converters

0.55 kW to 132 kW (0.75 hp to 150 hp)

## SINAMICS G120C compact converters

### Selection and ordering data

The article number is selected corresponding to

- the required motor power or the motor current required and the overload requirements of the application,
- the necessary EMC classification and
- the required integrated fieldbus interface

Rated power <sup>1)</sup>		Base-load current $I_L$ <sup>2)</sup>	Base-load current $I_H$ <sup>3)</sup>	Frame size	Version	SINAMICS G120C without line filter	SINAMICS G120C with integrated line filter class A
kW	hp	A	A			Article No.	Article No.
<b>380 ... 480 V 3 AC</b>							
0.55	0.75	1.7	1.3	FSA	USS, Modbus RTU	<b>6SL3210-1KE11-8UB2</b>	<b>6SL3210-1KE11-8AB2</b>
					PROFIBUS DP	<b>6SL3210-1KE11-8UP2</b>	<b>6SL3210-1KE11-8AP2</b>
					PROFINET, EtherNet/IP	<b>6SL3210-1KE11-8UF2</b>	<b>6SL3210-1KE11-8AF2</b>
0.75	1	2.2	1.7	FSA	USS, Modbus RTU	<b>6SL3210-1KE12-3UB2</b>	<b>6SL3210-1KE12-3AB2</b>
					PROFIBUS DP	<b>6SL3210-1KE12-3UP2</b>	<b>6SL3210-1KE12-3AP2</b>
					PROFINET, EtherNet/IP	<b>6SL3210-1KE12-3UF2</b>	<b>6SL3210-1KE12-3AF2</b>
1.1	1.5	3.1	2.2	FSA	USS, Modbus RTU	<b>6SL3210-1KE13-2UB2</b>	<b>6SL3210-1KE13-2AB2</b>
					PROFIBUS DP	<b>6SL3210-1KE13-2UP2</b>	<b>6SL3210-1KE13-2AP2</b>
					PROFINET, EtherNet/IP	<b>6SL3210-1KE13-2UF2</b>	<b>6SL3210-1KE13-2AF2</b>
1.5	2	4.1	3.1	FSA	USS, Modbus RTU	<b>6SL3210-1KE14-3UB2</b>	<b>6SL3210-1KE14-3AB2</b>
					PROFIBUS DP	<b>6SL3210-1KE14-3UP2</b>	<b>6SL3210-1KE14-3AP2</b>
					PROFINET, EtherNet/IP	<b>6SL3210-1KE14-3UF2</b>	<b>6SL3210-1KE14-3AF2</b>
2.2	3	5.6	4.1	FSA	USS, Modbus RTU	<b>6SL3210-1KE15-8UB2</b>	<b>6SL3210-1KE15-8AB2</b>
					PROFIBUS DP	<b>6SL3210-1KE15-8UP2</b>	<b>6SL3210-1KE15-8AP2</b>
					PROFINET, EtherNet/IP	<b>6SL3210-1KE15-8UF2</b>	<b>6SL3210-1KE15-8AF2</b>
3	4	7.3	5.6	FSA	USS, Modbus RTU	<b>6SL3210-1KE17-5UB1</b>	<b>6SL3210-1KE17-5AB1</b>
					PROFIBUS DP	<b>6SL3210-1KE17-5UP1</b>	<b>6SL3210-1KE17-5AP1</b>
					PROFINET, EtherNet/IP	<b>6SL3210-1KE17-5UF1</b>	<b>6SL3210-1KE17-5AF1</b>
4	5	8.8	7.3	FSA	USS, Modbus RTU	<b>6SL3210-1KE18-8UB1</b>	<b>6SL3210-1KE18-8AB1</b>
					PROFIBUS DP	<b>6SL3210-1KE18-8UP1</b>	<b>6SL3210-1KE18-8AP1</b>
					PROFINET, EtherNet/IP	<b>6SL3210-1KE18-8UF1</b>	<b>6SL3210-1KE18-8AF1</b>
5.5	7.5	12.5	8.8	FSB	USS, Modbus RTU	<b>6SL3210-1KE21-3UB1</b>	<b>6SL3210-1KE21-3AB1</b>
					PROFIBUS DP	<b>6SL3210-1KE21-3UP1</b>	<b>6SL3210-1KE21-3AP1</b>
					PROFINET, EtherNet/IP	<b>6SL3210-1KE21-3UF1</b>	<b>6SL3210-1KE21-3AF1</b>
7.5	10	16.5	12.5	FSB	USS, Modbus RTU	<b>6SL3210-1KE21-7UB1</b>	<b>6SL3210-1KE21-7AB1</b>
					PROFIBUS DP	<b>6SL3210-1KE21-7UP1</b>	<b>6SL3210-1KE21-7AP1</b>
					PROFINET, EtherNet/IP	<b>6SL3210-1KE21-7UF1</b>	<b>6SL3210-1KE21-7AF1</b>
11	15	25	16.5	FSC	USS, Modbus RTU	<b>6SL3210-1KE22-6UB1</b>	<b>6SL3210-1KE22-6AB1</b>
					PROFIBUS DP	<b>6SL3210-1KE22-6UP1</b>	<b>6SL3210-1KE22-6AP1</b>
					PROFINET, EtherNet/IP	<b>6SL3210-1KE22-6UF1</b>	<b>6SL3210-1KE22-6AF1</b>
15	20	31	25	FSC	USS, Modbus RTU	<b>6SL3210-1KE23-2UB1</b>	<b>6SL3210-1KE23-2AB1</b>
					PROFIBUS DP	<b>6SL3210-1KE23-2UP1</b>	<b>6SL3210-1KE23-2AP1</b>
					PROFINET, EtherNet/IP	<b>6SL3210-1KE23-2UF1</b>	<b>6SL3210-1KE23-2AF1</b>
18.5	25	37	31	FSC	USS, Modbus RTU	<b>6SL3210-1KE23-8UB1</b>	<b>6SL3210-1KE23-8AB1</b>
					PROFIBUS DP	<b>6SL3210-1KE23-8UP1</b>	<b>6SL3210-1KE23-8AP1</b>
					PROFINET, EtherNet/IP	<b>6SL3210-1KE23-8UF1</b>	<b>6SL3210-1KE23-8AF1</b>
22	25	43	37	FSD	PROFINET, EtherNet/IP	<b>6SL3210-1KE24-4UF1</b>	<b>6SL3210-1KE24-4AF1</b>
30	30	58	43	FSD	PROFINET, EtherNet/IP	<b>6SL3210-1KE26-0UF1</b>	<b>6SL3210-1KE26-0AF1</b>
37	40	68	58	FSD	PROFINET, EtherNet/IP	<b>6SL3210-1KE27-0UF1</b>	<b>6SL3210-1KE27-0AF1</b>
45	50	82.5	68	FSD	PROFINET, EtherNet/IP	<b>6SL3210-1KE28-4UF1</b>	<b>6SL3210-1KE28-4AF1</b>
55	60	103	83	FSE	PROFINET, EtherNet/IP	<b>6SL3210-1KE31-1UF1</b>	<b>6SL3210-1KE31-1AF1</b>
75	75	136	103	FSF	PROFINET, EtherNet/IP	<b>6SL3210-1KE31-4UF1</b>	<b>6SL3210-1KE31-4AF1</b>
90	100	164	136	FSF	PROFINET, EtherNet/IP	<b>6SL3210-1KE31-7UF1</b>	<b>6SL3210-1KE31-7AF1</b>
110	125	201	164	FSF	PROFINET, EtherNet/IP	<b>6SL3210-1KE32-1UF1</b>	<b>6SL3210-1KE32-1AF1</b>
132	150	237	201	FSF	PROFINET, EtherNet/IP	<b>6SL3210-1KE32-4UF1</b>	<b>6SL3210-1KE32-4AF1</b>

<sup>1)</sup> The rated power of the device based on the rated output current  $I_L$  and a rated input voltage of 400 V 3 AC. The rated power is specified on the device rating plate.

<sup>2)</sup> The base-load current  $I_L$  is based on the duty cycle for low overload (LO). The current value is specified on the device rating plate.

<sup>3)</sup> The base-load current  $I_H$  is based on the duty cycle for high overload (HO). The current value is not specified on the device rating plate.

## SINAMICS G120C compact converters

0.55 kW to 132 kW (0.75 hp to 150 hp)

### SINAMICS G120C compact converters

#### Selection and ordering data

##### Optional firmware memory cards for SINAMICS G120C

Description	Article No.
<b>SINAMICS SD card 512 MB + firmware V4.7 SP13</b> (Multicard V4.7 SP13)	<b>6SL3054-7TG00-2BA0</b>
<b>SINAMICS SD card 512 MB + firmware V4.7 SP14</b> (Multicard V4.7 SP14)	<b>6SL3054-7TH00-2BA0</b>

More information on firmware V4.7 SP14:

<https://support.industry.siemens.com/cs/document/109817231>

For an overview and more information on all available firmware versions, see

<https://support.industry.siemens.com/cs/document/67364620>

##### Notes:

SINAMICS G120C compact converters with frame size FSAA can be operated as of firmware V4.7 SP3.

SINAMICS G120C compact converters with frame sizes FSD to FSF can be operated as of firmware V4.7 SP6.

## Technical specifications

Unless explicitly specified otherwise, the following technical specifications are valid for all SINAMICS G120C compact converters.

General technical specifications	
<b>Mechanical specifications</b>	
<b>Vibratory load</b>	
• Transport acc. to IEC 60721-3-2: 1997 <sup>1)</sup>	Class 2M3
• Operation acc. to IEC 60721-3-3: 2002	Class 3M1
<b>Shock load</b>	
• Transport acc. to IEC 60721-3-2: 1997 <sup>1)</sup>	Class 2M3
• Operation acc. to IEC 60721-3-3: 2002	Class 3M2
<b>Degree of protection</b>	IP20/ UL Open Type
<b>Permissible mounting position</b>	Vertical wall mounting
<b>Ambient conditions</b>	
<b>External 24 V supply</b> According to IEC 60204-1	Touch-proof SELV or PELV power supply. The supply voltage must not exceed 60 V DC under single-fault conditions.
<b>Protection class</b> According to IEC 61800-5-1	Class I (with protective grounding conductor)
<b>Humidity, max.</b>	95 % at 40 °C (104 °F), condensation and icing not permissible
<b>Ambient temperature</b>	
• Storage <sup>1)</sup> acc. to EN 60068-2-1	-40 ... +70 °C (-40 ... +158 °F)
• Transport <sup>1)</sup> acc. to EN 60068-2-1	-40 ... +70 °C (-40 ... +158 °F)
• Operation acc. to EN 60068-2-2	
- Frame sizes FSAA to FSC	-10 ... +40 °C (14 ... 104 °F) without derating
- Frame sizes FSD to FSF	-20 ... +40 °C (-4 ... +104 °F) without derating
- All frame sizes	>40 ... 50 °C (104 ... 122 °F) <a href="#">see derating characteristics</a>
- All frame sizes with Operator Panel	0 ... 50 °C (32 ... 122 °F) <a href="#">see also derating characteristics</a>
<b>Environmental class in operation</b>	
• Harmful chemical substances	Class 3C2 acc. to IEC 60721-3-3: 2002
• Organic/biological pollutants	Class 3B1 acc. to IEC 60721-3-3: 2002
• Degree of pollution	2 acc. to EN 61800
<b>Standards</b>	
<b>Compliance with standards <sup>2)</sup></b>	CE, UKCA, UL, cUL, RCM, SEMI F47, RoHS, EAC
<b>Fail-safe certification</b>	
• According to IEC 61508	Function: Safe Torque Off (STO) SIL 2
• According to EN ISO 13849-1	PL d and Category 3
<b>CE marking, according to</b>	EMC Directive 2014/30/EU Low Voltage Directive 2014/35/EU Eco-design requirements of EU Directive 2019/1781
<b>EMC Directive <sup>2)</sup></b>	
According to EN 61800-3	
<u>Interference immunity</u>	The SINAMICS G120C compact converters are tested according to the interference immunity requirements for environments according to Category C3.
<u>Interference emissions</u>	
• Frame sizes FSAA to FSF without integrated line filter	<sup>3)</sup>
• Frame sizes FSAA to FSC with integrated line filter class A	Observance of the limit values according to Category C3 Observance of the limit values for conducted interferences and field-conducted interference emissions according to Category C2 <sup>4) 5)</sup>
• Frame sizes FSAA to FSC without integrated line filter with optional line filter class B	Observance of the limit values for conducted interferences according to Category C1 and field-conducted interference emissions according to Category C2 <sup>4) 5)</sup>
• Frame sizes FSD to FSF with integrated line filter class A	Observance of the limit values according to Category C3 and C2 <sup>4)</sup>
	<b>Note:</b> The EMC product standard EN 61800-3 does not apply directly to a frequency converter but to a PDS (Power Drive System), which comprises the complete circuitry, motor and cables in addition to the converter. The frequency converters on their own do not generally require identification according to the EMC Directive.

<sup>1)</sup> In product packaging.

<sup>2)</sup> More information is available in the operating instructions on the internet at: [www.siemens.com/sinamics-g120c/documentation](http://www.siemens.com/sinamics-g120c/documentation)

<sup>3)</sup> Unfiltered devices are designed for operation in IT systems or in conjunction with an RCD. The customer must provide suitable RI suppression equipment to ensure that these devices comply with the limits defined for Category C3 or C2.

<sup>4)</sup> Max. permissible cable lengths [see Technical specifications for power electronics](#).

<sup>5)</sup> SINAMICS G120C compact converters, frame size FSB, with PROFINET interface (Article No.: 6SL3210-1KE21-AF1) additionally require a line reactor.

# SINAMICS G120C compact converters

0.55 kW to 132 kW (0.75 hp to 150 hp)

## SINAMICS G120C compact converters

### Technical specifications

SINAMICS G120C compact converter	USS, Modbus RTU version	PROFIBUS DP version	PROFINET, EtherNet/IP version
	6SL3210-1KE...B1 6SL3210-1KE...B2	6SL3210-1KE...P1 6SL3210-1KE...P2	6SL3210-1KE...F1 6SL3210-1KE...F2
<b>Integrated bus interface</b>			
<b>Fieldbus protocols</b>	<ul style="list-style-type: none"> <li>USS</li> <li>Modbus RTU (switchable using a parameter)</li> </ul>	PROFIBUS DP	<ul style="list-style-type: none"> <li>PROFINET</li> <li>EtherNet/IP               <ul style="list-style-type: none"> <li>- ODVA AC/DC drive</li> <li>- SINAMICS profiles</li> </ul> </li> </ul>
<b>Profiles</b>	–	<ul style="list-style-type: none"> <li>PROFdrive Profile V4.1</li> <li>PROFIsafe</li> </ul>	<ul style="list-style-type: none"> <li>PROFdrive Profile V4.1</li> <li>PROFIsafe</li> <li>PROFenergy</li> </ul>
<b>Hardware</b>	Plug-in terminal, insulated, USS: max. 187.5 kBaud, Modbus RTU: 19.2 kBaud, Bus terminating resistor that can be switched in	9-pin SUB-D socket, insulated, max. 12 Mbit/s, Device address can be set using DIP switches	2 × RJ45, max. 100 Mbit/s (full duplex), the device name can be stored on the device
<b>I/O interfaces</b>			
<b>Signal cable cross-section</b>	0.15 ... 1.5 mm <sup>2</sup> (28 ... 16 AWG)		
<b>Digital inputs – Standard</b>	6 isolated inputs Optically isolated; Free reference potential (own potential group) NPN/PNP logic can be selected using the wiring		
<ul style="list-style-type: none"> <li>Switching level: 0 → 1</li> <li>Switching level: 1 → 0</li> </ul>	11 V 5 V		
<b>Digital inputs, fail-safe</b>	1 When using the standard digital inputs (DI4+DI5) Safety function: Safe Torque Off (STO)		
<b>Digital outputs</b>	1 relay changeover contact 30 V DC, 0.5 A (ohmic load) 1 transistor 30 V DC, 0.5 A (ohmic load)		
<b>Analog inputs</b>	1 analog input Differential input Switchable between voltage (-10 ... +10 V) and current (0/4 ... 20 mA) using a DIP switch 10-bit resolution Can be used as additional digital input Analog inputs are protected in a voltage range of ± 30 V and have a common-mode voltage in the ± 15 V range.		
<ul style="list-style-type: none"> <li>Switching threshold: 0 → 1</li> <li>Switching threshold: 1 → 0</li> </ul>	4 V 1.6 V		
<b>Analog outputs</b>	1 analog output Non-isolated output Switchable between voltage (0 ... 10 V) and current (0/4 ... 20 mA) using a parameter Voltage mode: 10 V, min. burden 10 kΩ Current mode: 20 mA, max. burden 500 Ω The analog outputs have short-circuit protection		
<b>PTC/KTY interface</b>	1 motor temperature sensor input Connectable sensors PTC, Pt1000, KTY and bimetal, accuracy ±5 °C		
<b>Voltage supply for the integrated Control Unit</b>	24 V DC via the Power Module or by connecting to an external 20.4 ... 28.8 V DC power supply Typical input current: 500 mA at 24 V DC		
<b>Tool interfaces</b>			
<b>Memory card</b>	Optional SINAMICS SD card		
<b>Operator panels</b>	Optional BOP-2 Basic Operator Panel or IOP-2 Intelligent Operator Panel or SINAMICS G120 Smart Access		
<b>PC interface</b>	USB		

## SINAMICS G120C compact converters

0.55 kW to 132 kW (0.75 hp to 150 hp)

### SINAMICS G120C compact converters

#### Technical specifications

SINAMICS G120C compact converter	
<b>Open-loop/closed-loop control methods</b>	
V/f linear/quadratic/parameterizable	✓
V/f with flux current control (FCC)	✓
V/f ECO linear/quadratic	✓
Vector control, sensorless	✓
Vector control, with sensor	–
Torque control, sensorless	–
Torque control, with sensor	–
<b>Software functions</b>	
Setpoint input	✓
Fixed frequencies	16, parameterizable
JOG	✓
Digital motorized potentiometer (MOP)	✓
Ramp smoothing	✓
Extended ramp-function generator (with ramp smoothing Off3)	✓
Positioning down ramp	–
Slip compensation	✓
Signal interconnection with BICO technology	✓
Free function blocks (FFB) for logical and arithmetic operations	✓
Switchable drive data sets (DDS)	✓ (2)
Switchable command data sets (CDS)	✓ (2)
Flying restart	✓
Automatic restart after line supply failure or operating fault (AR)	✓
Technology controller (internal PID)	✓
Energy consumption counter	✓
Energy saving computer	✓
Thermal motor protection	✓ ( $R_t$ sensor: PTC, Pt1000, KTY and bimetal)
Thermal converter protection	✓
Motor identification	✓
Motor holding brake	✓
Auto-ramping ( $V_{dc\_max}$ controller)	✓
Kinetic buffering ( $V_{dc\_min}$ controller)	✓
<b>Braking functions</b>	
• DC braking	✓
• Compound braking	✓
• Dynamic braking with integrated braking chopper	✓

## SINAMICS G120C compact converters

0.55 kW to 132 kW (0.75 hp to 150 hp)

### SINAMICS G120C compact converters

#### Technical specifications

General technical specifications of the power electronics	
<b>Line voltage</b>	380 ... 480 V 3 AC +10 % -20 %
<b>Line supply requirements</b> <b>Short-circuit power ratio <math>R_{SC}</math></b>	No restriction
<b>Input frequency</b>	47 ... 63 Hz
<b>Output frequency</b>	<ul style="list-style-type: none"> <li>Control mode V/f: 0 ... 550 Hz</li> <li>Control mode Vector: 0 ... 240 Hz</li> </ul>
<b>Pulse frequency</b>	4 kHz, 2 kHz for converters with a rated power $\geq 75$ kW Higher pulse frequencies up to 16 kHz <a href="#">see derating data</a>
<b>Power factor <math>\lambda</math></b>	<ul style="list-style-type: none"> <li>Frame sizes FSAA to FSC: 0.7 ... 0.85</li> <li>Frame sizes FSD to FSF: <math>&gt;0.9</math></li> </ul>
<b>Offset factor <math>\cos \varphi</math></b>	$\geq 0.95$
<b>Efficiency class</b> According to IEC 61800-9-2	IE2
<b>Output voltage, max.</b> as % of input voltage	95 %
<b>Overload capability</b>	<ul style="list-style-type: none"> <li>Low overload LO Note: No reduction in base-load current <math>I_L</math> for use of overload 1.5 × base-load current <math>I_L</math> (i. e. 150 % overload) for 3 s plus 1.1 × base-load current <math>I_L</math> (i. e. 110 % overload) for 57 s within a cycle time of 300 s</li> <li>High overload HO Note: No reduction in base-load current <math>I_H</math> for use of overload 2 × base-load current <math>I_H</math> (i. e. 200 % overload) for 3 s plus 1.5 × base-load current <math>I_H</math> (i. e. 150 % overload) for 57 s within a cycle time of 300 s</li> </ul>
<b>Cooling</b>	Air cooling using an integrated fan
<b>Installation altitude</b>	Up to 1000 m (3281 ft) above sea level without derating, $> 1000$ m (3281 ft) <a href="#">see derating characteristics</a>
<b>Short Circuit Current Rating (SCCR)<sup>1)</sup>, max. acc. to UL</b>	100 kA <a href="#">See Recommended line-side overcurrent protection devices</a> – the value depends on the fuses and circuit breakers used
<b>Protection functions</b>	<ul style="list-style-type: none"> <li>Undervoltage</li> <li>Overvoltage</li> <li>Overload</li> <li>Ground fault</li> <li>Short-circuit</li> <li>Stall protection</li> <li>Motor blocking protection</li> <li>Motor overtemperature</li> <li>Converter overtemperature</li> </ul>

<sup>1)</sup> Applies to industrial control panel installations to NEC Article 409 or UL 508A.

# SINAMICS G120C compact converters

0.55 kW to 132 kW (0.75 hp to 150 hp)

## SINAMICS G120C compact converters

### Technical specifications

Line voltage 380 ... 480 V 3 AC		SINAMICS G120C power electronics			
		6SL3210-1KE11-8..2	6SL3210-1KE12-3..2	6SL3210-1KE13-2..2	6SL3210-1KE14-3..2
<b>Output current</b> at 400 V 3 AC					
• Rated current $I_N$ <sup>1)</sup>	A	1.8	2.3	3.2	4.3
• Base-load current $I_L$ <sup>2)</sup>	A	1.7	2.2	3.1	4.1
• Base-load current $I_H$ <sup>3)</sup>	A	1.3	1.7	2.2	3.1
• Maximum current $I_{max}$	A	2.6	3.4	4.4	6.2
<b>Rated power</b>					
• Based on $I_L$	kW	0.55	0.75	1.1	1.5
• Based on $I_H$	kW	0.37	0.55	0.75	1.1
<b>Rated pulse frequency</b>		kHz	4	4	4
<b>Efficiency <math>\eta</math></b> Acc. to IEC 61800-9-2		%	95.9	96.6	97.0
<b>Power loss <sup>4)</sup></b> Acc. to IEC 61800-9-2 At rated current		kW	0.034	0.039	0.048
<b>Cooling air requirement</b>		m <sup>3</sup> /s (ft <sup>3</sup> /s)	0.005 (0.18)	0.005 (0.18)	0.005 (0.18)
<b>Sound pressure level <math>L_{pA}</math> (1 m)</b>		dB	<49	<49	<49
<b>Rated input current <sup>5)</sup></b>					
• Based on $I_L$	A	2.3	2.9	4.1	5.5
• Based on $I_H$	A	1.9	2.5	3.2	4.5
<b>Length of cable to braking resistor, max.</b>		m (ft)	15 (49)	15 (49)	15 (49)
<b>Line supply connection</b> U1/L1, V1/L2, W1/L3			Plug-in screw terminals	Plug-in screw terminals	Plug-in screw terminals
• Conductor cross-section	mm <sup>2</sup>	1 ... 2.5 (18 ... 14 AWG)	1 ... 2.5 (18 ... 14 AWG)	1 ... 2.5 (18 ... 14 AWG)	1 ... 2.5 (18 ... 14 AWG)
<b>Motor connection</b> U2, V2, W2			Plug-in screw terminals	Plug-in screw terminals	Plug-in screw terminals
• Conductor cross-section	mm <sup>2</sup>	1 ... 2.5 (18 ... 14 AWG)	1 ... 2.5 (18 ... 14 AWG)	1 ... 2.5 (18 ... 14 AWG)	1 ... 2.5 (18 ... 14 AWG)
<b>Connection for braking resistor</b> R1, R2			Plug-in screw terminals	Plug-in screw terminals	Plug-in screw terminals
• Conductor cross-section	mm <sup>2</sup>	1 ... 2.5 (18 ... 14 AWG)	1 ... 2.5 (18 ... 14 AWG)	1 ... 2.5 (18 ... 14 AWG)	1 ... 2.5 (18 ... 14 AWG)
<b>PE connection</b>			On housing with M4 screw	On housing with M4 screw	On housing with M4 screw
<b>Motor cable length, max. <sup>6)</sup></b>					
• Without filter, shielded/unshielded	m (ft)	150/150 (492/492)	150/150 (492/492)	150/150 (492/492)	150/150 (492/492)
• With integrated filter class A, shielded/unshielded	m (ft)	50/100 (164/328)	50/100 (164/328)	50/100 (164/328)	50/100 (164/328)
<b>Dimensions</b>					
• Width	mm (in)	73 (2.87)	73 (2.87)	73 (2.87)	73 (2.87)
• Height	mm (in)	173 (6.81)	173 (6.81)	173 (6.81)	173 (6.81)
• Depth					
- Without operator panel	mm (in)	155 (6.10) (PN version: 160 (6.30))	155 (6.10) (PN version: 160 (6.30))	155 (6.10) (PN version: 160 (6.30))	155 (6.10) (PN version: 160 (6.30))
- With BOP-2/IOP-2	mm (in)	166 (6.54) (PN version: 171 (6.73))	166 (6.54) (PN version: 171 (6.73))	166 (6.54) (PN version: 171 (6.73))	166 (6.54) (PN version: 171 (6.73))
<b>Frame size</b>			FSAA	FSAA	FSAA
<b>Weight, approx.</b>					
• Without filter	kg (lb)	1.1 (2.43) (PN version: 1.2 (2.65))	1.1 (2.43) (PN version: 1.2 (2.65))	1.1 (2.43) (PN version: 1.2 (2.65))	1.1 (2.43) (PN version: 1.2 (2.65))
• With integrated filter class A	kg (lb)	1.3 (2.87) (PN version: 1.4 (3.09))	1.3 (2.87) (PN version: 1.4 (3.09))	1.3 (2.87) (PN version: 1.4 (3.09))	1.3 (2.87) (PN version: 1.4 (3.09))

<sup>1)</sup> The rated output current  $I_N$  can be used up to 100 %; however, without overload.

<sup>2)</sup> The base-load current  $I_L$  is based on the duty cycle for low overload (LO).

<sup>3)</sup> The base-load current  $I_H$  is based on the duty cycle for high overload (HO).

<sup>4)</sup> Typical values. More information can be found on the internet at <https://support.industry.siemens.com/cs/document/94059311>

<sup>5)</sup> The rated input currents are valid for an input voltage of 400 V 3 AC and a line impedance corresponding to  $u_k = 1\%$  (without line reactor). The rated input current based on  $I_L$  is stamped on the converter rating plate. In the particular application, the input current depends on the motor load and line impedance. The input current is reduced when using a line reactor.

<sup>6)</sup> The maximum motor cable lengths are valid for an input voltage of 400 V 3 AC and operation with a 4 kHz pulse frequency. When a converter with an integrated line filter class A is used to comply with the limits of EN 61800-3 Category C2 for line-conducted interference emission, the maximum permissible motor cable length is 25 m (shielded) as standard – and 50 m with low-capacitance CY cable (shielded).

# SINAMICS G120C compact converters

0.55 kW to 132 kW (0.75 hp to 150 hp)

## SINAMICS G120C compact converters

### Technical specifications

Line voltage 380 ... 480 V 3 AC		SINAMICS G120C power electronics			
		6SL3210-1KE15-8..2	6SL3210-1KE17-5..1	6SL3210-1KE18-8..1	6SL3210-1KE21-3..1
<b>Output current</b> at 400 V 3 AC					
• Rated current $I_N$ <sup>1)</sup>	A	5.8	7.5	9	13
• Base-load current $I_L$ <sup>2)</sup>	A	5.6	7.3	8.8	12.5
• Base-load current $I_H$ <sup>3)</sup>	A	4.1	5.6	7.3	8.8
• Maximum current $I_{max}$	A	8.2	11.2	14.6	17.6
<b>Rated power</b>					
• Based on $I_L$	kW	2.2	3	4	5.5
• Based on $I_H$	kW	1.5	2.2	3	4
<b>Rated pulse frequency</b>		kHz	4	4	4
<b>Efficiency <math>\eta</math></b> Acc. to IEC 61800-9-2		%	97.4	97.3	97.3
<b>Power loss <sup>4)</sup></b> Acc. to IEC 61800-9-2 At rated current		kW	0.073	0.098	0.119
<b>Cooling air requirement</b>		m <sup>3</sup> /s (ft <sup>3</sup> /s)	0.005 (0.18)	0.005 (0.18)	0.005 (0.18)
<b>Sound pressure level <math>L_{pA}</math> (1 m)</b>		dB	<49	<52	<52
<b>Rated input current <sup>5)</sup></b>					
• Based on $I_L$	A	7.4	9.5	11.4	16.5
• Based on $I_H$	A	6	8.2	10.6	12.8
<b>Length of cable to braking resistor, max.</b>		m (ft)	15 (49)	15 (49)	15 (49)
<b>Line supply connection</b> U1/L1, V1/L2, W1/L3			Plug-in screw terminals	Plug-in screw terminals	Plug-in screw terminals
• Conductor cross-section	mm <sup>2</sup>	1 ... 2.5 (18 ... 14 AWG)	1 ... 2.5 (18 ... 14 AWG)	1 ... 2.5 (18 ... 14 AWG)	4 ... 6 (12 ... 10 AWG)
<b>Motor connection</b> U2, V2, W2			Plug-in screw terminals	Plug-in screw terminals	Plug-in screw terminals
• Conductor cross-section	mm <sup>2</sup>	1 ... 2.5 (18 ... 14 AWG)	1 ... 2.5 (18 ... 14 AWG)	1 ... 2.5 (18 ... 14 AWG)	4 ... 6 (12 ... 10 AWG)
<b>Connection for braking resistor</b> R1, R2			Plug-in screw terminals	Plug-in screw terminals	Plug-in screw terminals
• Conductor cross-section	mm <sup>2</sup>	1 ... 2.5 (18 ... 14 AWG)	1 ... 2.5 (18 ... 14 AWG)	1 ... 2.5 (18 ... 14 AWG)	4 ... 6 (12 ... 10 AWG)
<b>PE connection</b>			On housing with M4 screw	On housing with M4 screw	On housing with M4 screw
<b>Motor cable length, max. <sup>6)</sup></b>					
• Without filter, shielded/unshielded	m (ft)	125 <sup>7)</sup> /150 (410 <sup>7)</sup> /492)	150/150 (492/492)	150/150 (492/492)	150/150 (492/492)
• With integrated filter class A, shielded/unshielded	m (ft)	50/100 (164/328)	50/100 (164/328)	50/100 (164/328)	50/100 (164/328)
<b>Dimensions</b>					
• Width	mm (in)	73 (2.87)	73 (2.87)	73 (2.87)	100 (3.94)
• Height	mm (in)	173 (6.81)	196 (7.72)	196 (7.72)	196 (7.72)
• Depth					
- Without operator panel	mm (in)	155 (6.10) (PN version: 160 (6.30))	203 (7.99)	203 (7.99)	203 (7.99)
- With BOP-2/IOP-2	mm (in)	166 (6.54) (PN version: 171 (6.73))	214 (8.43)	214 (8.43)	214 (8.43)
<b>Frame size</b>			FSAA	FSA	FSA
<b>Weight, approx.</b>					
• Without filter	kg (lb)	1.1 (2.43) (PN version: 1.2 (2.65))	1.7 (3.75)	1.7 (3.75)	2.3 (5.07)
• With integrated filter class A	kg (lb)	1.3 (2.87) (PN version: 1.4 (3.09))	1.9 (4.19)	1.9 (4.19)	2.5 (5.51)

- <sup>1)</sup> The rated output current  $I_N$  can be used up to 100 %; however, without overload.
- <sup>2)</sup> The base-load current  $I_L$  is based on the duty cycle for low overload (LO).
- <sup>3)</sup> The base-load current  $I_H$  is based on the duty cycle for high overload (HO).
- <sup>4)</sup> Typical values. More information can be found on the internet at <https://support.industry.siemens.com/cs/document/94059311>

- <sup>5)</sup> The rated input currents are valid for an input voltage of 400 V 3 AC and a line impedance corresponding to  $u_K = 1$  % (without line reactor). The rated input current based on  $I_L$  is stamped on the converter rating plate. In the particular application, the input current depends on the motor load and line impedance. The input current is reduced when using a line reactor.
- <sup>6)</sup> The maximum motor cable lengths are valid for an input voltage of 400 V 3 AC and operation with a 4 kHz pulse frequency. When a converter with an integrated line filter class A is used to comply with the limits of EN 61800-3 Category C2 for line-conducted interference emissions, the maximum permissible motor cable length is 25 m (shielded) as standard – for frame sizes FSAA to FSB with low-capacitance CY cable (shielded) it is 50 m.
- <sup>7)</sup> With low-capacitance CY cable 150 m (shielded).



# SINAMICS G120C compact converters

0.55 kW to 132 kW (0.75 hp to 150 hp)

## SINAMICS G120C compact converters

### Technical specifications

Line voltage 380 ... 480 V 3 AC		SINAMICS G120C power electronics			
		6SL3210-1KE21-7..1	6SL3210-1KE22-6..1	6SL3210-1KE23-2..1	6SL3210-1KE23-8..1
<b>Output current</b> at 400 V 3 AC					
• Rated current $I_N$ <sup>1)</sup>	A	17	26	32	38
• Base-load current $I_L$ <sup>2)</sup>	A	16.5	25	31	37
• Base-load current $I_H$ <sup>3)</sup>	A	12.5	16.5	25	31
• Maximum current $I_{max}$	A	25	33	50	62
<b>Rated power</b>					
• Based on $I_L$	kW	7.5	11	15	18.5
• Based on $I_H$	kW	5.5	7.5	11	15
<b>Rated pulse frequency</b>		kHz	4	4	4
<b>Efficiency <math>\eta</math></b> Acc. to IEC 61800-9-2		%	97.5	97.9	97.9
<b>Power loss</b> <sup>4)</sup> Acc. to IEC 61800-9-2 At rated current		kW	0.228	0.292	0.361
<b>Cooling air requirement</b>		m <sup>3</sup> /s (ft <sup>3</sup> /s)	0.009 (0.32)	0.018 (0.64)	0.018 (0.64)
<b>Sound pressure level <math>L_{pA}</math> (1 m)</b>		dB	<63	<66	<66
<b>Rated input current</b> <sup>5)</sup>					
• Based on $I_L$	A	21.5	33	40.6	48.2
• Based on $I_H$	A	18.2	24.1	36.4	45.2
<b>Length of cable to braking resistor, max.</b>		m (ft)	15 (49)	15 (49)	15 (49)
<b>Line supply connection</b> U1/L1, V1/L2, W1/L3			Plug-in screw terminals	Plug-in screw terminals	Plug-in screw terminals
• Conductor cross-section	mm <sup>2</sup>	4 ... 6 (12 ... 10 AWG)	6 ... 16 (10 ... 5 AWG)	10 ... 16 (7 ... 5 AWG)	10 ... 16 (7 ... 5 AWG)
<b>Motor connection</b> U2, V2, W2			Plug-in screw terminals	Plug-in screw terminals	Plug-in screw terminals
• Conductor cross-section	mm <sup>2</sup>	4 ... 6 (12 ... 10 AWG)	6 ... 16 (10 ... 5 AWG)	10 ... 16 (7 ... 5 AWG)	10 ... 16 (7 ... 5 AWG)
<b>Connection for braking resistor</b> R1, R2			Plug-in screw terminals	Plug-in screw terminals	Plug-in screw terminals
• Conductor cross-section	mm <sup>2</sup>	4 ... 6 (12 ... 10 AWG)	6 ... 16 (10 ... 5 AWG)	10 ... 16 (7 ... 5 AWG)	10 ... 16 (7 ... 5 AWG)
<b>PE connection</b>			On housing with M4 screw	On housing with M4 screw	On housing with M4 screw
<b>Motor cable length, max.</b> <sup>6)</sup>					
• Without filter, shielded/unshielded	m (ft)	150/150 (492/492)	150/150 (492/492)	150/150 (492/492)	150/150 (492/492)
• With integrated filter class A, shielded/unshielded	m (ft)	50/100 (164/328)	50/100 (164/328)	50/100 (164/328)	50/100 (164/328)
<b>Dimensions</b>					
• Width	mm (in)	100 (3.94)	140 (5.51)	140 (5.51)	140 (5.51)
• Height	mm (in)	196 (7.72)	295 (11.61)	295 (11.61)	295 (11.61)
• Depth					
- Without operator panel	mm (in)	203 (7.99)	203 (7.99)	203 (7.99)	203 (7.99)
- With BOP-2/IOP-2	mm (in)	214 (8.43)	214 (8.43)	214 (8.43)	214 (8.43)
<b>Frame size</b>			FSB	FSC	FSC
<b>Weight, approx.</b>					
• Without filter	kg (lb)	2.3 (5.07)	4.4 (9.70)	4.4 (9.70)	4.4 (9.70)
• With integrated filter class A	kg (lb)	2.5 (5.51)	4.7 (10.4)	4.7 (10.4)	4.7 (10.4)

1) The rated output current  $I_N$  can be used up to 100 %; however, without overload.  
 2) The base-load current  $I_L$  is based on the duty cycle for low overload (LO).  
 3) The base-load current  $I_H$  is based on the duty cycle for high overload (HO).  
 4) Typical values. More information can be found on the internet at <https://support.industry.siemens.com/cs/document/94059311>

5) The rated input currents are valid for an input voltage of 400 V 3 AC and a line impedance corresponding to  $u_k = 1\%$  (without line reactor). The rated input current based on  $I_L$  is stamped on the converter rating plate. In the particular application, the input current depends on the motor load and line impedance. The input current is reduced when using a line reactor.

6) The maximum motor cable lengths are valid for an input voltage of 400 V 3 AC and operation with a 4 kHz pulse frequency. When a converter with an integrated line filter class A is used to comply with the limits of EN 61800-3 Category C2 for line-conducted interference emission, the maximum permissible motor cable length is 25 m (shielded) as standard – with low-capacitance CY cable for frame size FSB 50 m (shielded), for FSC 100 m (shielded).

# SINAMICS G120C compact converters

0.55 kW to 132 kW (0.75 hp to 150 hp)

## SINAMICS G120C compact converters

### Technical specifications

Line voltage 380 ... 480 V 3 AC		SINAMICS G120C power electronics			
		6SL3210-1KE24-4.F1	6SL3210-1KE26-0.F1	6SL3210-1KE27-0.F1	6SL3210-1KE28-4.F1
<b>Output current</b> at 400 V 3 AC					
• Rated current $I_N$ <sup>1)</sup>	A	43	58	68	82.5
• Base-load current $I_L$ <sup>2)</sup>	A	43	58	68	82.5
• Base-load current $I_H$ <sup>3)</sup>	A	37	43	58	68
• Maximum current $I_{max}$	A	74	87	116	136
<b>Rated power</b>					
• Based on $I_L$	kW	22	30	37	45
• Based on $I_H$	kW	18.5	22	30	37
<b>Rated pulse frequency</b>		kHz	4	4	4
<b>Efficiency <math>\eta</math></b> Acc. to IEC 61800-9-2		%	97.1	96.8	97.1
<b>Power loss</b> <sup>4)</sup> Acc. to IEC 61800-9-2 At rated current		kW	0.696	1.04	1.08
<b>Cooling air requirement</b>		m <sup>3</sup> /s (ft <sup>3</sup> /s)	0.055 (1.94)	0.055 (1.94)	0.055 (1.94)
<b>Sound pressure level <math>L_{pA}</math> (1 m)</b>		dB	71.6	71.6	71.6
<b>Rated input current</b> <sup>5)</sup>					
• Based on $I_L$	A	41	53	64	76
• Based on $I_H$	A	39	44	61	69
<b>Length of cable to braking resistor, max.</b>		m (ft)	10 (32.8)	10 (32.8)	10 (32.8)
<b>Line supply connection</b> U1/L1, V1/L2, W1/L3			Screw terminals	Screw terminals	Screw terminals
• Conductor cross-section	mm <sup>2</sup>	10 ... 35 (20 ... 10 AWG)	10 ... 35 (20 ... 10 AWG)	10 ... 35 (20 ... 10 AWG)	10 ... 35 (20 ... 10 AWG)
<b>Motor connection</b> U2, V2, W2			Screw terminals	Screw terminals	Screw terminals
• Conductor cross-section	mm <sup>2</sup>	10 ... 35 (20 ... 10 AWG)	10 ... 35 (20 ... 10 AWG)	10 ... 35 (20 ... 10 AWG)	10 ... 35 (20 ... 10 AWG)
<b>Connection for braking resistor</b> R1, R2			Screw terminals	Screw terminals	Screw terminals
• Conductor cross-section	mm <sup>2</sup>	10 ... 35 (20 ... 10 AWG)	10 ... 35 (20 ... 10 AWG)	10 ... 35 (20 ... 10 AWG)	10 ... 35 (20 ... 10 AWG)
<b>PE connection</b>			On housing with M4 screw	On housing with M4 screw	On housing with M4 screw
<b>Motor cable length, max.</b> <sup>6)</sup>					
• Without filter, shielded/unshielded	m (ft)	200/300 (656/984)	200/300 (656/984)	200/300 (656/984)	200/300 (656/984)
• With integrated filter class A, shielded/unshielded	m (ft)	200/300 (656/984)	200/300 (656/984)	200/300 (656/984)	200/300 (656/984)
<b>Dimensions</b>					
• Width	mm (in)	200 (7.87)	200 (7.87)	200 (7.87)	200 (7.87)
• Height	mm (in)	472 (18.58)	472 (18.58)	472 (18.58)	472 (18.58)
• Depth					
- Without operator panel	mm (in)	237 (9.33)	237 (9.33)	237 (9.33)	237 (9.33)
- With BOP-2/IOP-2	mm (in)	248 (9.76)	248 (9.76)	248 (9.76)	248 (9.76)
<b>Frame size</b>			FSD	FSD	FSD
<b>Weight, approx.</b>					
• Without filter	kg (lb)	17 (37.5)	17 (37.5)	18 (39.7)	18 (39.7)
• With integrated filter class A	kg (lb)	19 (41.9)	19 (41.9)	20 (44.1)	20 (44.1)

<sup>1)</sup> The rated output current  $I_N$  can be used up to 100 %; however, without overload.

<sup>2)</sup> The base-load current  $I_L$  is based on the duty cycle for low overload (LO).

<sup>3)</sup> The base-load current  $I_H$  is based on the duty cycle for high overload (HO).

<sup>4)</sup> Typical values. More information can be found on the internet at <https://support.industry.siemens.com/cs/document/94059311>

<sup>5)</sup> The rated input currents are valid for an input voltage of 400 V 3 AC and a line impedance corresponding to  $u_K = 1$  %. The rated input current based on  $I_L$  is stamped on the converter rating plate. In the particular application, the input current depends on the motor load and line impedance.

<sup>6)</sup> The maximum motor cable lengths are valid for an input voltage of 400 V 3 AC and operation with a 4 kHz pulse frequency. When a converter with an integrated line filter class A is used to comply with the limits of EN 61800-3 Category C2 for line-conducted interference emissions, the maximum permissible motor cable length is 150 m (shielded) as standard.

# SINAMICS G120C compact converters

0.55 kW to 132 kW (0.75 hp to 150 hp)

## SINAMICS G120C compact converters

### Technical specifications

Line voltage 380 ... 480 V 3 AC		SINAMICS G120C power electronics				
		6SL3210-1KE31-1.F1	6SL3210-1KE31-4.F1	6SL3210-1KE31-7.F1	6SL3210-1KE32-1.F1	6SL3210-1KE32-4.F1
<b>Output current</b> at 400 V 3 AC						
• Rated current $I_N$ <sup>1)</sup>	A	103	136	164	201	237
• Base-load current $I_L$ <sup>2)</sup>	A	103	136	164	201	237
• Base-load current $I_H$ <sup>3)</sup>	A	83	103	136	164	201
• Maximum current $I_{max}$	A	165	206	272	328	402
<b>Rated power</b>						
• Based on $I_L$	kW	55	75	90	110	132
• Based on $I_H$	kW	45	55	75	90	110
<b>Rated pulse frequency</b>	kHz	4	2	2	2	2
<b>Efficiency <math>\eta</math></b> Acc. to IEC 61800-9-2	%	97.3	98.0	97.9	98.0	97.8
<b>Power loss</b> <sup>4)</sup> Acc. to IEC 61800-9-2 At rated current	kW	1.57	1.52	1.95	2.31	2.89
<b>Cooling air requirement</b>	m <sup>3</sup> /s (ft <sup>3</sup> /s)	0.083 (2.93)	0.153 (5.40)	0.153 (5.40)	0.153 (5.40)	0.153 (5.40)
<b>Sound pressure level <math>L_{pA}</math> (1 m)</b>	dB	70.6	67.7	67.7	67.7	67.7
<b>Rated input current</b> <sup>5)</sup>						
• Based on $I_L$	A	96	134	156	187	221
• Based on $I_H$	A	85	112	144	169	207
<b>Length of cable to braking resistor, max.</b>	m (ft)	10 (32.8)	10 (32.8)	10 (32.8)	10 (32.8)	10 (32.8)
<b>Line supply connection</b> U1/L1, V1/L2, W1/L3		Screw terminals	Screw terminals	Screw terminals	Screw terminals	Screw terminals
• Conductor cross-section	mm <sup>2</sup>	25 ... 70 (6 ... 3/0 AWG)	35 ... 2x120 (1 ... 2x4/0 AWG)	35 ... 2x120 (1 ... 2x4/0 AWG)	35 ... 2x120 (1 ... 2x4/0 AWG)	35 ... 2x120 (1 ... 2x4/0 AWG)
<b>Motor connection</b> U2, V2, W2		Screw terminals	Screw terminals	Screw terminals	Screw terminals	Screw terminals
• Conductor cross-section	mm <sup>2</sup>	25 ... 70 (6 ... 3/0 AWG)	35 ... 2x120 (1 ... 2x4/0 AWG)	35 ... 2x120 (1 ... 2x4/0 AWG)	35 ... 2x120 (1 ... 2x4/0 AWG)	35 ... 2x120 (1 ... 2x4/0 AWG)
<b>Connection for braking resistor</b> R1, R2		Screw terminals	Screw terminals	Screw terminals	Screw terminals	Screw terminals
• Conductor cross-section	mm <sup>2</sup>	25 ... 70 (6 ... 3/0 AWG)	35 ... 2x120 (1 ... 2x4/0 AWG)	35 ... 2x120 (1 ... 2x4/0 AWG)	35 ... 2x120 (1 ... 2x4/0 AWG)	35 ... 2x120 (1 ... 2x4/0 AWG)
<b>PE connection</b>		On housing with M4 screw	On housing with M4 screw	On housing with M4 screw	On housing with M4 screw	On housing with M4 screw
<b>Motor cable length, max.</b> <sup>6)</sup>						
• Without filter, shielded/unshielded	m (ft)	200/300 (656/984)	300/450 (984/1476)	300/450 (984/1476)	300/450 (984/1476)	300/450 (984/1476)
• With integrated filter class A, shielded/unshielded	m (ft)	200/300 (656/984)	300/450 (984/1476)	300/450 (984/1476)	300/450 (984/1476)	300/450 (984/1476)
<b>Dimensions</b>						
• Width	mm (in)	275 (10.83)	305 (12.01)	305 (12.01)	305 (12.01)	305 (12.01)
• Height	mm (in)	551 (21.69)	708 (27.87)	708 (27.87)	708 (27.87)	708 (27.87)
• Depth						
- Without operator panel	mm (in)	237 (9.33)	357 (14.06)	357 (14.06)	357 (14.06)	357 (14.06)
- With BOP-2/IOP-2	mm (in)	248 (9.76)	368 (14.49)	368 (14.49)	368 (14.49)	368 (14.49)
<b>Frame size</b>		FSE	FSF	FSF	FSF	FSF
<b>Weight, approx.</b>						
• Without filter	kg (lb)	27 (59.5)	59 (130)	59 (130)	62 (137)	62 (137)
• With integrated filter class A	kg (lb)	29 (63.9)	64 (141)	64 (141)	66 (146)	66 (146)

<sup>1)</sup> The rated output current  $I_N$  can be used up to 100 %; however, without overload.  
<sup>2)</sup> The base-load current  $I_L$  is based on the duty cycle for low overload (LO).  
<sup>3)</sup> The base-load current  $I_H$  is based on the duty cycle for high overload (HO).  
<sup>4)</sup> Typical values. More information can be found on the internet at <https://support.industry.siemens.com/cs/document/94059311>

<sup>5)</sup> The rated input currents are valid for an input voltage of 400 V 3 AC and a line impedance corresponding to  $u_k = 1\%$ . The rated input current based on  $I_L$  is stamped on the converter rating plate. In the particular application, the input current depends on the motor load and line impedance.  
<sup>6)</sup> The maximum motor cable lengths are valid for an input voltage of 400 V 3 AC and operation with a 4 kHz pulse frequency. When a converter with an integrated line filter class A is used to comply with the limits of EN 61800-3 Category C2 for line-conducted interference emissions, the maximum permissible motor cable length is 150 m (shielded) as standard.

## SINAMICS G120C compact converters

0.55 kW to 132 kW (0.75 hp to 150 hp)

### SINAMICS G120C compact converters

#### Characteristic curves

##### Derating data

##### Pulse frequency

Rated power based on low overload (LO)		Rated output current in A for a pulse frequency of							
kW	hp	2 kHz	4 kHz	6 kHz	8 kHz	10 kHz	12 kHz	14 kHz	16 kHz
0.55	0.75	1.7	1.7	1.4	1.2	1	0.9	0.8	0.7
0.75	1	2.2	2.2	1.9	1.5	1.3	1.1	1	0.9
1.1	1.5	3.1	3.1	2.6	2.2	1.9	1.6	1.4	1.2
1.5	2	4.1	4.1	3.5	2.9	2.5	2.1	1.8	1.6
2.2	3	5.6	5.6	4.8	3.9	3.4	2.8	2.5	2.2
3	4	7.3	7.3	6.2	5.1	4.4	3.7	3.3	2.9
4	5	8.8	8.8	7.5	6.2	5.3	4.4	4	3.5
5.5	7.5	12.5	12.5	10.6	8.8	7.5	6.3	5.6	5
7.5	10	16.5	16.5	14	11.6	9.9	8.3	7.4	6.6
11	15	25	25	21.3	17.5	15	12.5	11.3	10
15	20	31	31	26.4	21.7	18.6	15.5	14	12.4
18.5	25	37	37	31.5	25.9	22.2	18.5	16.7	14.8
22	25	43	43	36.6	30.1	25.8	21.5	19.4	17.2
30	30	58	58	49.3	40.6	34.8	29	26.1	23.2
37	40	68	68	57.8	47.6	40.8	34	30.6	27.2
45	50	82.5	82.5	70.1	57.8	49.5	41.3	37.1	33
55	60	103	103	87.6	72.1	–	–	–	–
75	75	136	136	115.6	95.2	–	–	–	–
90	100	164	164	139.4	114.8	–	–	–	–
110	125	201	140.7	–	–	–	–	–	–
132	150	237	165.9	–	–	–	–	–	–

The permissible motor cable length depends on the cable type and the pulse frequency.

## Characteristic curves

### Ambient temperature

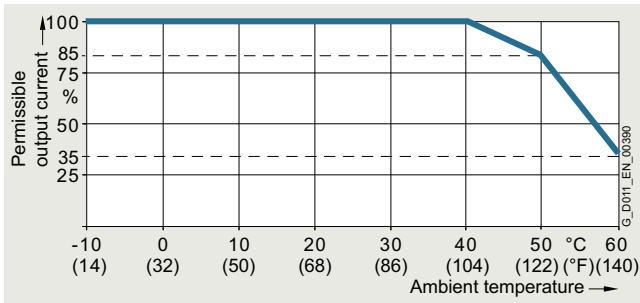

Permissible output current as a function of the ambient temperature, frame sizes FSAA to FSC

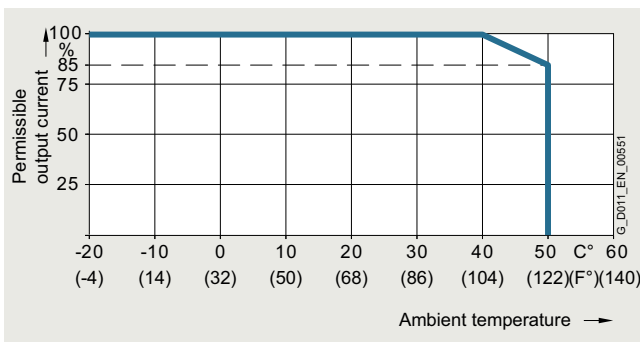

Permissible output current as a function of the ambient temperature, frame sizes FSD to FSF

For the frame sizes FSA to FSC, the PROFINET version can be butt-mounted at temperatures up to 55 °C. The frame sizes FSAA and FSD to FSF can be butt-mounted at temperatures up to 50 °C.

### Installation altitude

Permissible line supplies as a function of the installation altitude

- Installation altitude up to 2000 m (6562 ft) above sea level
  - Connection to every supply system permitted for the converter
- Installation altitudes between 2000 m (6562 ft) and 4000 m (13124 ft) above sea level
  - Connection only to a TN system with grounded neutral point
  - TN systems with grounded line conductor are not permitted
  - The TN line system with grounded neutral point can also be supplied using an isolation transformer
  - The phase-to-phase voltage does not have to be reduced

The connected motors, power elements and components must be considered separately.

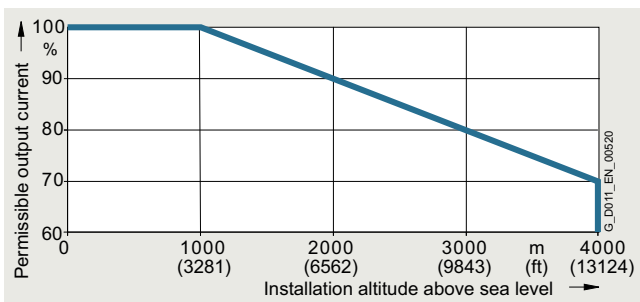

Permissible output current as a function of the installation altitude, frame sizes FSAA to FSF at 40 °C for low overload (LO)

### Current/power derating as a function of the line voltage

The SINAMICS G120C compact converter supplies a constant power in the line voltage range 380 V to 480 V 3 AC. The constant power results in current derating as a function of the line voltage.

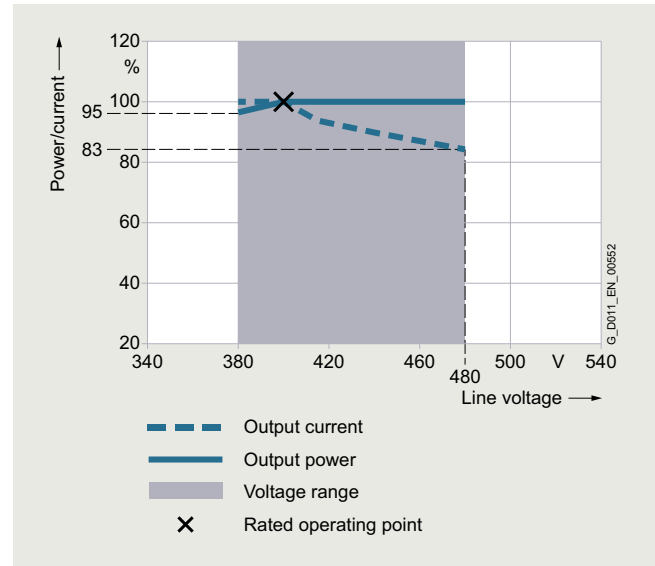

Current derating as a function of the line voltage

More information on the derating data of the SINAMICS G120C compact converter can be found in the operating instructions on the internet at:

[www.siemens.com/sinamics-g120c/documentation](http://www.siemens.com/sinamics-g120c/documentation)

## SINAMICS G120C compact converters

0.55 kW to 132 kW (0.75 hp to 150 hp)

### SINAMICS G120C compact converters

#### Dimensional drawings

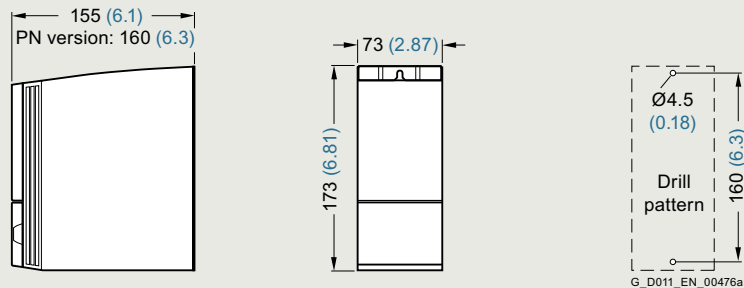

SINAMICS G120C, frame size FSAA

Mounted with 2 M4 bolts, 2 M4 nuts, 2 M4 washers.

When the shield plate is mounted, the drilling pattern is compatible with frame size FSA.

Ventilation clearance required at the top: 80 mm (3.15 inches).

Ventilation clearance required at the bottom: 100 mm (3.94 inches).

Ventilation clearance required at the side: 0 mm (0 inches).

When the BOP-2/IOP-2 is plugged on, the overall depth increases by 11 mm (0.43 inches).

All dimensions in mm (values in brackets are in inches).

8

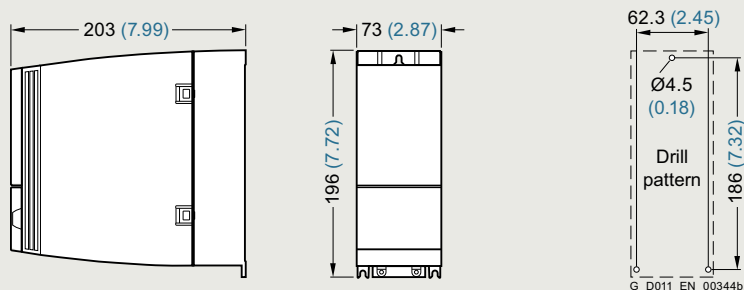

SINAMICS G120C, frame size FSA

Mounted with 3 M4 bolts, 3 M4 nuts, 3 M4 washers.

Ventilation clearance required at the top: 80 mm (3.15 inches).

Ventilation clearance required at the bottom: 100 mm (3.94 inches).

Ventilation clearance required at the side: 0 mm (0 inches).

When the BOP-2/IOP-2 is plugged on, the overall depth increases by 11 mm (0.43 inches).

All dimensions in mm (values in brackets are in inches).

## SINAMICS G120C compact converters

0.55 kW to 132 kW (0.75 hp to 150 hp)

### SINAMICS G120C compact converters

#### Dimensional drawings

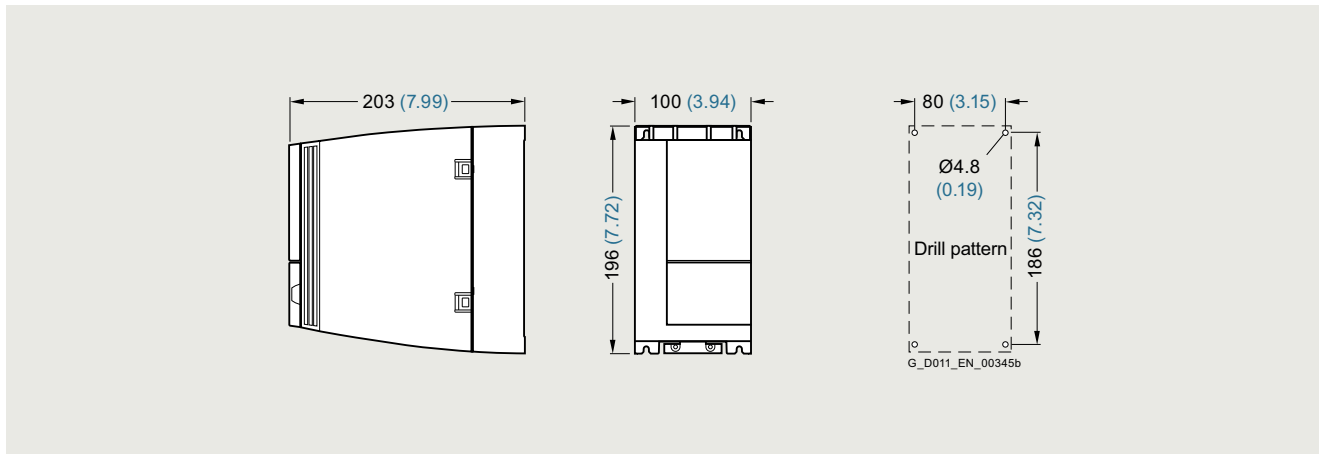

SINAMICS G120C, frame size FSB

Mounted with 4 M4 bolts, 4 M4 nuts, 4 M4 washers.

Ventilation clearance required at the top: 80 mm (3.15 inches).

Ventilation clearance required at the bottom: 100 mm (3.94 inches).

Ventilation clearance required at the side: 0 mm (0 inches).

When the BOP-2/IOP-2 is plugged on, the overall depth increases by 11 mm (0.43 inches).

All dimensions in mm (values in brackets are in inches).

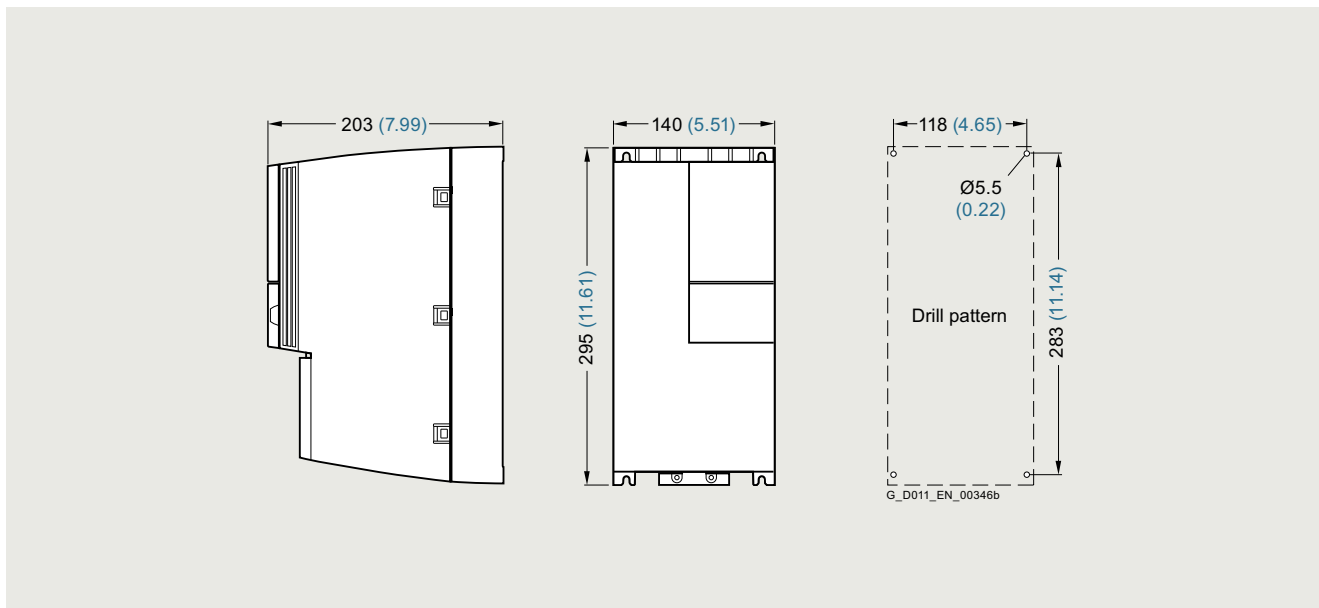

SINAMICS G120C, frame size FSC

Mounted with 4 M5 bolts, 4 M5 nuts, 4 M5 washers.

Ventilation clearance required at the top: 80 mm (3.15 inches).

Ventilation clearance required at the bottom: 100 mm (3.94 inches).

Ventilation clearance required at the side: 0 mm (0 inches).

When the BOP-2/IOP-2 is plugged on, the overall depth increases by 11 mm (0.43 inches).

All dimensions in mm (values in brackets are in inches).

## SINAMICS G120C compact converters

0.55 kW to 132 kW (0.75 hp to 150 hp)

### SINAMICS G120C compact converters

#### Dimensional drawings

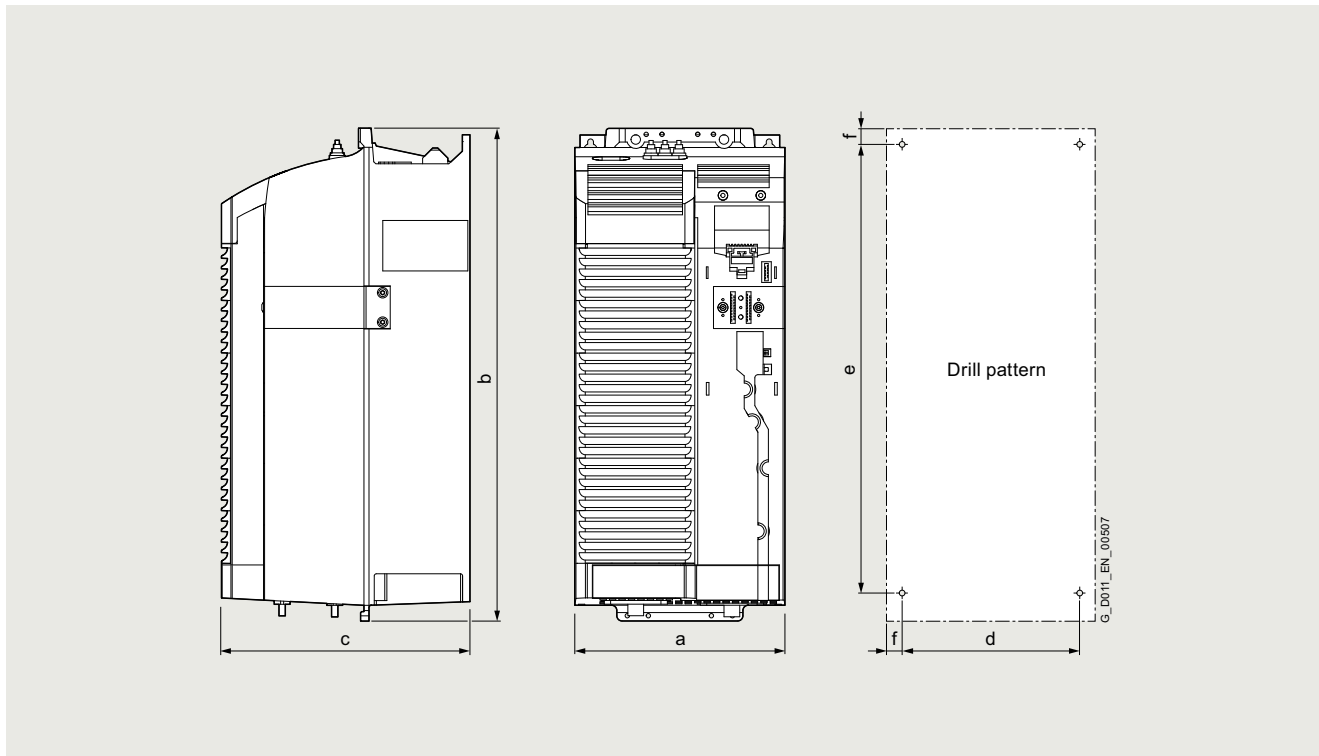

SINAMICS G120C frame sizes FSD to FSF

SINAMICS G120C Frame size	Dimensions in mm (inches)			Drilling dimensions in mm (inches)			Cooling clearance in mm (inches)			Mounting With bolts
	a (width)	b (height)	c (depth)	d	e	f	top	bottom	front	
FSD	200 (7.87)	472 (18.58)	237 (9.33)	170 (6.69)	430 (16.93)	15 (0.59)	300 (11.81)	350 (13.78)	100 (3.94)	4 × M5
FSE	275 (10.83)	551 (21.69)	237 (9.33)	230 (9.06)	509 (20.04)	11 (0.43)	300 (11.81)	350 (13.78)	100 (3.94)	4 × M6
FSF	305 (12.01)	708 (27.87)	357 (14.06)	270 (10.63)	680 (26.77)	13 (0.51)	300 (11.81)	350 (13.78)	100 (3.94)	4 × M8

When the BOP-2/IOP-2 is plugged on, the overall depth increases by 11 mm (0.43 inches).

#### More information

A hard copy of the Compact Operating Instructions is supplied for SINAMICS G120C. Further documentation, such as Operating Instructions and List Manuals, is available for download free of charge from the internet at:

[www.siemens.com/sinamics-g120c/documentation](http://www.siemens.com/sinamics-g120c/documentation)

Detailed information on SINAMICS G120C, the latest technical documentation (brochures, tutorials, dimensional drawings, certificates, manuals and operating instructions) is available on the internet at:

[www.siemens.com/sinamics-g120c](http://www.siemens.com/sinamics-g120c)

In addition, the Siemens Product Configurator can be used on the internet. The Siemens Product Configurator can be found in the Siemens Industry Mall at the following address:

[www.siemens.com/spc](http://www.siemens.com/spc)

Furthermore, the SINAMICS SELECTOR app is a practical tool that helps you find article numbers for SINAMICS V20, SINAMICS V90, SINAMICS G120C, SINAMICS G120P, SINAMICS G120X, SINAMICS G120 and SINAMICS S210 converters in the output range from 0.1 kW to 630 kW quickly and easily. You will find the free downloads for Android and for iOS at the following link:

[www.siemens.com/sinamics-selector](http://www.siemens.com/sinamics-selector)



# SINAMICS G120C compact converters

0.55 kW to 132 kW (0.75 hp to 150 hp)

Line-side components &gt; Line filters

## Overview



Line filter for SINAMICS G120C, frame size FSAA

With a line filter, the SINAMICS G120C can achieve a higher radio interference class.

All SINAMICS G120C converters are available without and with integrated line filter.

For SINAMICS G120C frame sizes FSAA to FSC, external line filters suitable for base mounting are available.

## Selection and ordering data

Rated power		SINAMICS G120C		Line filter class B according to EN 55011
kW	hp	Type 6SL3210-...	Frame size	
0.55	0.75	1KE11-8U.2	FSAA	6SL3203-0BE17-7BA0
0.75	1	1KE12-3U.2		
1.1	1.5	1KE13-2U.2		
1.5	2	1KE14-3U.2		
2.2	3	1KE15-8U.2	FSA	6SL3203-0BE21-8BA0
3	4	1KE17-5U.1		
4	5.5	1KE18-8U.1	FSB	6SL3203-0BE23-8BA0
5.5	7.5	1KE21-3U.1		
7.5	10	1KE21-7U.1	FSC	6SL3203-0BE23-8BA0
11	15	1KE22-6U.1		
15	20	1KE23-2U.1		
18.5	25	1KE23-8U.1		

## Technical specifications

Line voltage 380 ... 480 V 3 AC		Line filter class B		
		6SL3203-0BE17-7BA0	6SL3203-0BE21-8BA0	6SL3203-0BE23-8BA0
<b>Rated current</b>	A	11.4	23.5	49.4
<b>Pulse frequency</b>	kHz	4 ... 16	4 ... 16	4 ... 16
<b>Line supply connection</b> L1, L2, L3		Screw terminals	Screw terminals	Screw terminals
• Conductor cross-section	mm <sup>2</sup>	1 ... 2.5	2.5 ... 6	6 ... 16
<b>Load connection</b> U, V, W		Shielded cable	Shielded cable	Shielded cable
• Cable cross-section	mm <sup>2</sup>	1.5	4	10
• Length	m (ft)	0.45 (1.48)	0.5 (1.64)	0.54 (1.77)
<b>PE connection</b>		On housing via M5 screw stud	On housing via M5 screw stud	On housing via M6 screw studs
• Conductor cross-section	mm <sup>2</sup>	1 ... 2.5	2.5 ... 6	6 ... 16
<b>Degree of protection</b>		IP20	IP20	IP20
<b>Dimensions</b>				
• Width	mm (in)	73 (2.87)	100 (3.94)	140 (5.51)
• Height	mm (in)	202 (7.95)	297 (11.69)	359 (14.13)
• Depth	mm (in)	65 (2.56)	85 (3.35)	95 (3.74)
<b>Possible as base component</b>		Yes	Yes	Yes
<b>Weight, approx.</b>	kg (lb)	1.75 (3.86)	4 (8.82)	7.3 (16.1)
<b>Suitable for SINAMICS G120C</b>	Type	FSAA 6SL3210-1KE11-8U.2 6SL3210-1KE12-3U.2 6SL3210-1KE13-2U.2 6SL3210-1KE14-2U.2 6SL3210-1KE15-8U.2 FSA 6SL3210-1KE17-5U.1 6SL3210-1KE18-8U.1	6SL3210-1KE21-3U.1 6SL3210-1KE21-7U.1	6SL3210-1KE22-6U.1 6SL3210-1KE23-2U.1 6SL3210-1KE23-8U.1
• Frame size		FSAA/FSA	FSB	FSC

## SINAMICS G120C compact converters

0.55 kW to 132 kW (0.75 hp to 150 hp)

### Line-side components > Line reactors

#### Overview

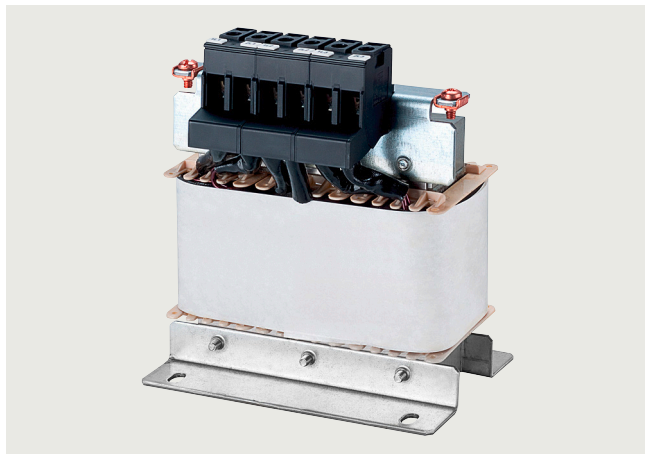

Line reactor for SINAMICS G120C frame size FSB

Line reactors smooth the current drawn by the converter and thus reduce harmonic components in the line current. Through the reduction of the current harmonics, the thermal load on the power components in the rectifier and in the DC link capacitors is reduced as well as the harmonic effects on the supply. The use of a line reactor increases the service life of the converter.

If the ratio of the rated converter power to the line supply short-circuit power is less than 1 %, then it is recommended to use a line reactor to reduce the current peaks.

A DC link reactor is integrated in the SINAMICS G120C compact converter frame sizes FSD to FSF and therefore no line reactor is required.

#### Selection and ordering data

Rated power		SINAMICS G120C		Line reactor
kW	hp	Type 6SL3210-...	Frame size	Article No.
<b>Line voltage 380 ... 480 V 3 AC</b>				
0.55	0.75	1KE11-8..2	FSA	<b>6SL3203-OCE13-2AA0</b>
0.75	1	1KE12-3..2		
1.1	1.5	1KE13-2..2		
1.5	2	1KE14-3..2	FSA	<b>6SL3203-OCE21-0AA0</b>
2.2	3	1KE15-8..2		
3	4	1KE17-5..1	FSA	
4	5	1KE18-8..1		<b>6SL3203-OCE21-8AA0</b>
5.5	7.5	1KE21-3..1	FSB	
7.5	10	1KE21-7..1		
11	15	1KE22-6..1	FSC	<b>6SL3203-OCE23-8AA0</b>
15	20	1KE23-2..1		
18.5	25	1KE23-8..1		

Line reactors that are suitable for base mounting are also available for SINAMICS G120C, frame size FSA, 0.55 kW to 2.2 kW.

- 0.55 kW: 6SE6400-3CC00-2AD3
- 0.75 kW to 1.1 kW: 6SE6400-3CC00-4AD3
- 1.5 kW to 2.2 kW: 6SE6400-3CC00-6AD3

For 2.2 kW, operation of the line reactors that are suitable for base mounting is only permitted for operating the converter with rated power of 1.5 kW based on high overload (HO).

More information is available in the operating instructions on the internet at:

[www.siemens.com/sinamics-g120c/documentation](http://www.siemens.com/sinamics-g120c/documentation)

#### Technical specifications

Line voltage 380 ... 480 V 3 AC		Line reactor			
		6SL3203-OCE13-2AA0	6SL3203-OCE21-0AA0	6SL3203-OCE21-8AA0	6SL3203-OCE23-8AA0
<b>Rated current</b>	A	4	11.3	22.3	47
<b>Power loss at 50/60 Hz</b>	W	23/26	36/40	53/59	88/97
<b>Line supply/load connection</b> 1L1, 1L2, 1L3 2L1, 2L2, 2L3		Screw terminals	Screw terminals	Screw terminals	Screw terminals
• Conductor cross-section	mm <sup>2</sup>	4	4	10	16
<b>PE connection</b>		M4 × 8; U washer; spring lock washer	M4 × 8; U washer; spring lock washer	M5 × 10; U washer; spring lock washer	M5 × 10; U washer; spring lock washer
<b>Degree of protection</b>		IP20	IP20	IP20	IP20
<b>Dimensions</b>					
• Width	mm (in)	125 (4.92)	125 (4.92)	125 (4.92)	190 (7.48)
• Height	mm (in)	120 (4.72)	140 (5.51)	145 (5.71)	220 (8.66)
• Depth	mm (in)	71 (2.80)	71 (2.80)	91 (3.58)	91 (3.58)
<b>Weight, approx.</b>	kg (lb)	1.1 (2.4)	2.1 (4.6)	2.95 (6.5)	7.8 (17.2)
<b>Suitable for SINAMICS G120C</b>	Type	6SL3210-1KE11-8..2 6SL3210-1KE12-3..2 6SL3210-1KE13-2..2	FSA 6SL3210-1KE14-3..2 6SL3210-1KE15-8..2 FSA 6SL3210-1KE17-5..1 6SL3210-1KE18-8..1	6SL3210-1KE21-3..1 6SL3210-1KE21-7..1	6SL3210-1KE22-6..1 6SL3210-1KE23-2..1 6SL3210-1KE23-8..1
• Frame size		FSA	FSA/FSA	FSB	FSC

## SINAMICS G120C compact converters

0.55 kW to 132 kW (0.75 hp to 150 hp)

### Line-side components > Recommended line-side overcurrent protection devices

#### Selection and ordering data

Overcurrent protection devices are absolutely necessary for the operation of the converters. The following table lists recommendations for fuses.

- Siemens fuses of type 3NA3 for use in the area of validity of IEC
- UL-listed fuses Class J for use in USA and Canada

Recommendations on further overcurrent protection devices are available at:

<https://support.industry.siemens.com/cs/document/109750343>

The Short Circuit Current Rating (SCCR) according to UL for industrial control panel installations to NEC Article 409 or UL 508A/508C or UL 61800-5-1 is as follows for Class J fuses for

- SINAMICS G120C: 100 kA

SCCR and ICC values for combination with further overcurrent protection devices are available at:

<https://support.industry.siemens.com/cs/document/109750343>

#### Notes for installations in Canada:

The converters are intended for line supply systems with over-voltage category III. Additional information is available in the technical documentation on the internet at:

[www.siemens.com/sinamics-g120c/documentation](http://www.siemens.com/sinamics-g120c/documentation)

Additional information about the listed Siemens fuses is available in Catalog LV 10 as well as in the Industry Mall.

Rated power		SINAMICS G120C		IEC-compliant Fuse		UL/cUL-compliant Fuse type	
kW	hp	Type 6SL3210-...	Frame size	Current A	3NA3 Article No.	Rated voltage 600 V AC Class	Current A
<b>Line voltage 380 ... 480 V 3 AC</b>							
0.55	0.75	1KE11-8..2	FSA	10	<b>3NA3803</b>	J	10
0.75	1	1KE12-3..2					
1.1	1.5	1KE13-2..2					
1.5	2	1KE14-3..2					
2.2	3	1KE15-8..2					
3	4	1KE17-5..1	FSA	16	<b>3NA3805</b>	J	15
4	5	1KE18-8..1					
5.5	7.5	1KE21-3..1	FSB	32	<b>3NA3812</b>	J	35
7.5	10	1KE21-7..1					
11	15	1KE22-6..1	FSC	63	<b>3NA3822</b>	J	60
15	20	1KE23-2..1					
18.5	25	1KE23-8..1					
22	30	1KE24-4.F1	FSD	80	<b>3NA3824</b>	J	70
30	40	1KE26-0.F1	FSD	100	<b>3NA3830</b>	J	90
37	50	1KE27-0.F1				J	100
45	60	1KE28-4.F1	FSD	125	<b>3NA3832</b>	J	125
55	75	1KE31-1.F1	FSE	160	<b>3NA3836</b>	J	150
75	100	1KE31-4.F1	FSF	200	<b>3NA3140</b>	J	200
90	125	1KE31-7.F1	FSF	224	<b>3NA3142</b>	J	250
110	150	1KE32-1.F1	FSF	300	<b>3NA3250</b>	J	300
132	200	1KE32-4.F1	FSF	315	<b>3NA3252</b>	J	350

## SINAMICS G120C compact converters

0.55 kW to 132 kW (0.75 hp to 150 hp)

DC link components > Braking resistors

### Overview



Braking resistor for SINAMICS G120C, frame size FSB

Excess energy in the DC link is dissipated in the braking resistor. The braking resistors are designed for use with the SINAMICS G120C. SINAMICS G120C has an integrated brake chopper and cannot feed back regenerative energy to the line supply. For regenerative operation, e.g. the braking of a rotating mass with high moment of inertia, a braking resistor must be connected to convert the resulting energy into heat.

The braking resistors are designed for mounting horizontally or vertically onto a heat-resistant sheet steel panel. The resistors should be mounted such as to ensure that the air can flow in and out and heat cannot build up. The heat dissipated by the braking resistor must not diminish the converter cooling.

Every braking resistor is equipped with a temperature switch. The temperature switch can be evaluated to prevent consequential damage if the braking resistor overheats.

#### Note:

For the electromagnetically compatible connection of an optionally connectable braking resistor, the corresponding shield connection kit is to be ordered for frame sizes FSD to FSF. For more information, see shield connection kits in the section Supplementary system components.

### Selection and ordering data

Rated power		SINAMICS G120C		<b>Braking resistor</b> The prefix "JJY:" is part of a Siemens internal order code that does not belong to the product number of the original manufacturer, Heine Resistor GmbH.	
kW	hp	Type 6SL3210-...	Frame size	Article No.	
<b>Line voltage 380 ... 480 V 3 AC</b>					
0.55	0.75	1KE11-8..2	FSA	<b>6SL3201-0BE14-3AA0</b>	
0.75	1	1KE12-3..2			
1.1	1.5	1KE13-2..2			
1.5	2	1KE14-3..2			
2.2	3	1KE15-8..2	FSA	<b>6SL3201-0BE21-0AA0</b>	
3	4	1KE17-5..1	FSA		
4	5	1KE18-8..1			
5.5	7.5	1KE21-3..1	FSB	<b>6SL3201-0BE21-8AA0</b>	
7.5	10	1KE21-7..1			
11	15	1KE22-6..1	FSC	<b>6SL3201-0BE23-8AA0</b>	
15	20	1KE23-2..1			
18.5	25	1KE23-8..1			
22	30	1KE24-4.F1	FSD	<b>JJY:023422620001</b>	
30	40	1KE26-0.F1	FSD	<b>JJY:023424020001</b>	
37	50	1KE27-0.F1			
45	60	1KE28-4.F1	FSD	<b>JJY:023434020001</b>	
55	75	1KE31-1.F1	FSE	<b>JJY:023434020001</b>	
75	100	1KE31-4.F1	FSF	<b>JJY:023454020001</b>	
90	125	1KE31-7.F1			
110	150	1KE32-1.F1	FSF	<b>JJY:023464020001</b>	
132	200	1KE32-4.F1			

A braking resistor **6SE6400-4BD11-0AA0** that is suitable for base mounting is also available for SINAMICS G120C, frame size FSA, 0.55 kW to 2.2 kW. For 2.2 kW, operation of the braking resistor that is suitable for base mounting is only permitted for operating the converter with rated power of 1.5 kW based on high overload (HO).

More information is available in the operating instructions on the internet at:

[www.siemens.com/sinamics-g120c/documentation](http://www.siemens.com/sinamics-g120c/documentation)

### Characteristic curves

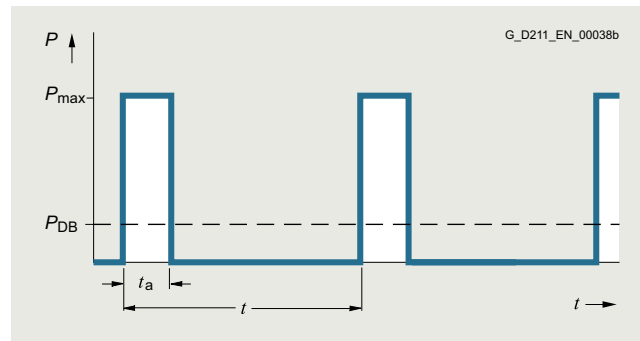

Load diagram for the braking resistors

$t_a = 12$  s  
 $t = 240$  s

## SINAMICS G120C compact converters

0.55 kW to 132 kW (0.75 hp to 150 hp)

DC link components > Braking resistors

### Technical specifications

Line voltage 380 ... 480 V 3 AC		Braking resistor			
		6SL3201-0BE14-3AA0	6SL3201-0BE21-0AA0	6SL3201-0BE21-8AA0	6SL3201-0BE23-8AA0
<b>Resistance</b>	Ω	370	140	75	30
<b>Rated power <math>P_{DB}</math></b> (Continuous braking power)	kW	0.075	0.2	0.375	0.925
<b>Peak power <math>P_{max}</math></b> (load duration $t_a = 12$ s with period $t = 240$ s)	kW	1.5	4	7.5	18.5
<b>Power connection</b>		Terminal block	Terminal block	Terminal block	Terminal block
• Conductor cross-section	mm <sup>2</sup>	2.5	2.5	2.5	6
<b>Thermostatic switch</b>		NC contact	NC contact	NC contact	NC contact
• Contact load, max.		250 V AC/2.5 A	250 V AC/2.5 A	250 V AC/2.5 A	250 V AC/2.5 A
• Conductor cross-section	mm <sup>2</sup>	2.5	2.5	2.5	2.5
<b>PE connection</b>					
• Via terminal block		Yes	Yes	Yes	Yes
• PE connection on housing		M4 screw	M4 screw	M4 screw	M4 screw
<b>Degree of protection</b>		IP20	IP20	IP20	IP20
<b>Dimensions</b>					
• Width	mm (in)	105 (4.13)	105 (4.13)	175 (6.89)	250 (9.84)
• Height	mm (in)	295 (11.61)	345 (13.58)	345 (13.58)	490 (19.29)
• Depth	mm (in)	100 (3.94)	100 (3.94)	100 (3.94)	140 (5.51)
<b>Weight, approx.</b>	kg (lb)	1.48 (3.26)	1.8 (3.97)	2.73 (6.02)	6.2 (13.7)
<b>Suitable for SINAMICS G120C</b>	Type	6SL3210-1KE11-8..2 6SL3210-1KE12-3..2 6SL3210-1KE13-2..2 6SL3210-1KE14-3..2	FSAA 6SL3210-1KE15-8..2 FSA 6SL3210-1KE17-5..1 6SL3210-1KE18-8..1	6SL3210-1KE21-3..1 6SL3210-1KE21-7..1	6SL3210-1KE22-6..1 6SL3210-1KE23-2..1 6SL3210-1KE23-8..1
• Frame size		FSAA	FSAA/FSA	FSB	FSC

Line voltage 380 ... 480 V 3 AC		Braking resistor				
		JJY:02342262000 1	JJY:02342402000 1	JJY:02343402000 1	JJY:023454020001 <sup>1)</sup>	JJY:023464020001 <sup>2)</sup>
<b>Resistance</b>	Ω	25	15	10	7.1	5
<b>Rated power <math>P_{DB}</math></b> (Continuous braking power)	kW	1.1	1.85	2.75	3.85	5.5
<b>Peak power <math>P_{max}</math></b> (load duration $t_a = 12$ s with period $t = 240$ s)	kW	22	37	55	77	110
<b>Power connection</b>		Cable	Cable	Cable	Cable	Cable
<b>Thermostatic switch</b>		Integrated	Integrated	Integrated	Integrated	Integrated
<b>Degree of protection</b>		IP21	IP21	IP21	IP21	IP21
<b>Dimensions</b>						
• Width	mm (in)	220 (8.66)	220 (8.66)	350 (13.78)	1)	2)
• Height	mm (in)	470 (18.50)	610 (24.02)	630 (24.80)	1)	2)
• Depth	mm (in)	180 (7.09)	180 (7.09)	180 (7.09)	1)	2)
<b>Weight, approx.</b>	kg (lb)	7 (15.4)	9.5 (20.9)	13.5 (29.8)	20.5 (45.2)	27 (59.5)
<b>Suitable for SINAMICS G120C</b>	Type	6SL3210-1KE24-4.F1	6SL3210-1KE26-0.F1 6SL3210-1KE27-0.F1	FSD 6SL3210-1KE28-4.F1 FSE 6SL3210-1KE31-1.F1	6SL3210-1KE31-4.F1 6SL3210-1KE31-7.F1	6SL3210-1KE32-1.F1 6SL3210-1KE32-4.F1
• Frame size		FSD	FSD	FSD/FSE	FSF	FSF

<sup>1)</sup> This braking resistor consists of the two braking resistors, JJY:023422620001 and JJY:023434020001, which must be connected in parallel on the plant/system side.

<sup>2)</sup> This braking resistor consists of two JJY:023434020001 braking resistors, which must be connected in parallel on the plant/system side.

## SINAMICS G120C compact converters

0.55 kW to 132 kW (0.75 hp to 150 hp)

Load-side power components > Output reactors

### Overview

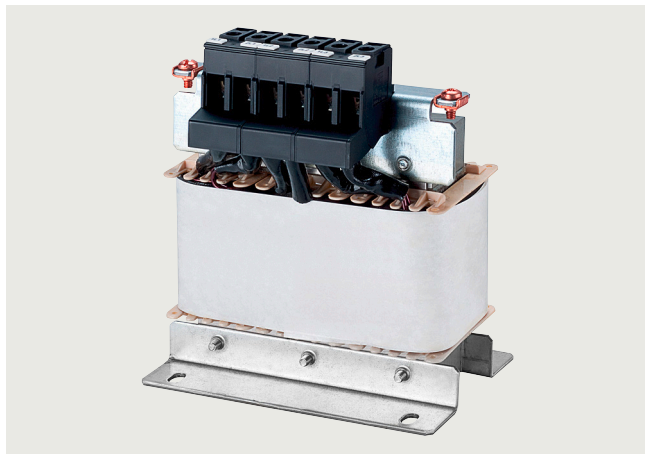

Output reactor for SINAMICS G120C, frame size FSA

Output reactors reduce the rate of voltage rise ( $dv/dt$ ) and the height of the current peaks, and enable longer motor cables to be connected.

Owing to the high rates of voltage rise of the fast-switching IGBTs, the capacitance of long motor cables reverses polarity very quickly with every switching operation in the inverter. As a result, the inverter is loaded with additional current peaks of substantial magnitude.

Output reactors reduce the magnitude of these additional peaks because the cable capacitance reverses polarity more slowly across the reactor inductance, thereby attenuating the amplitudes of the current peaks.

When using output reactors, the following should be observed:

- Max. permissible output frequency 150 Hz
- Max. permissible pulse frequency 4 kHz
- The output reactor must be installed as close as possible to the converter

### Selection and ordering data

Rated power		SINAMICS G120C		Output reactor
kW	hp	Type 6SL3210-...	Frame size	Article No.
<b>380 ... 480 V 3 AC</b>				
0.55	0.75	1KE11-8..2	FSA	<b>6SL3202-0AE16-1CA0</b>
0.75	1	1KE12-3..2		
1.1	1.5	1KE13-2..2		
1.5	2	1KE14-3..2		
2.2	3	1KE15-8..2		
3	4	1KE17-5..1	FSA	<b>6SL3202-0AE18-8CA0</b>
4	5	1KE18-8..1		
5.5	7.5	1KE21-3..1	FSB	<b>6SL3202-0AE21-8CA0</b>
7.5	10	1KE21-7..1		
11	15	1KE22-6..1	FSC	<b>6SL3202-0AE23-8CA0</b>
15	20	1KE23-2..1		
18.5	25	1KE23-8..1		
22	30	1KE24-4.F1	FSD	<b>6SE6400-3TC07-5ED0</b>
30	40	1KE26-0.F1		
37	50	1KE27-0.F1		
45	60	1KE28-4.F1	FSD	<b>6SE6400-3TC14-5FD0</b>
55	75	1KE31-1.F1	FSE	<b>6SE6400-3TC14-5FD0</b>
75	100	1KE31-4.F1	FSF	<b>6SE6400-3TC14-5FD0</b>
90	125	1KE31-7.F1		
110	150	1KE32-1.F1	FSF	<b>6SL3000-2BE32-1AA0</b>
132	200	1KE32-4.F1	FSF	<b>6SL3000-2BE32-6AA0</b>

An output reactor 6SE6400-3TC00-4AD2 that is suitable for base mounting is also available for SINAMICS G120C, frame size FSA, 0.55 kW to 2.2 kW. For 2.2 kW, operation of the output reactor that is suitable for base mounting is only permitted for operating the converter with rated power of 1.5 kW based on high overload (HO).

More information is available in the operating instructions on the internet at:

[www.siemens.com/sinamics-g120c/documentation](http://www.siemens.com/sinamics-g120c/documentation)

## SINAMICS G120C compact converters

0.55 kW to 132 kW (0.75 hp to 150 hp)

### Load-side power components > Output reactors

#### Technical specifications

Line voltage 380 ... 480 V 3 AC		Output reactor				
		6SL3202-0AE16-1CA0	6SL3202-0AE18-8CA0	6SL3202-0AE21-8CA0	6SL3202-0AE23-8CA0	
Rated current	A	6.1	9	18.5	39	
Power loss	kW	0.09	0.08	0.08	0.11	
<b>Connection to the Power Module/ motor connection</b>		Screw terminals	Screw terminals	Screw terminals	Screw terminals	
• Conductor cross-section	mm <sup>2</sup>	4	4	10	16	
<b>PE connection</b>		M4 screw stud	M4 screw stud	M5 screw stud	M5 screw stud	
<b>Cable length, max.</b> between output reactor and motor						
• 380 V -10 % ... 415 V +10 % 3 AC						
- Shielded	m (ft)	150 (492)	150 (492)	150 (492)	150 (492)	
- Unshielded	m (ft)	225 (738)	225 (738)	225 (738)	225 (738)	
• 440 ... 480 V 3 AC +10 %						
- Shielded	m (ft)	100 (328)	100 (328)	100 (328)	100 (328)	
- Unshielded	m (ft)	150 (492)	150 (492)	150 (492)	150 (492)	
<b>Dimensions</b>						
• Width	mm (in)	207 (8.15)	207 (8.15)	247 (9.72)	257 (10.12)	
• Height	mm (in)	175 (6.89)	180 (7.09)	215 (8.46)	235 (9.25)	
• Depth	mm (in)	72.5 (2.85)	72.5 (2.85)	100 (3.94)	114.7 (4.52)	
<b>Possible as base component</b>		No	No	No	No	
<b>Degree of protection</b>		IP20	IP20	IP20	IP20	
<b>Weight, approx.</b>		kg (lb)	3.4 (7.50)	3.9 (8.60)	10.1 (22.3)	11.2 (24.7)
<b>Suitable for SINAMICS G120C</b>		Type	6SL3210-1KE11-8..2 6SL3210-1KE12-3..2 6SL3210-1KE13-2..2 6SL3210-1KE14-3..2 6SL3210-1KE15-8..2	6SL3210-1KE17-5..1 6SL3210-1KE18-8..1	6SL3210-1KE21-3..1 6SL3210-1KE21-7..1	6SL3210-1KE22-6..1 6SL3210-1KE23-2..1 6SL3210-1KE23-8..1
• Frame size		FSAA	FSA	FSB	FSC	

Line voltage 380 ... 480 V 3 AC		Output reactor				
		6SE6400-3TC07-5ED0	6SE6400-3TC14-5FD0	6SL3000-2BE32-1AA0	6SL3000-2BE32-6AA0	
Rated current	A	90 <sup>1)</sup>	178 <sup>1)</sup>	210	260	
Power loss	kW	0.27	0.47	0.49	0.5	
<b>Connection to the Power Module/ motor connection</b>		Flat connector for M6 cable lug	Flat connector for M8 cable lug	Flat connector for M10 cable lug	Flat connector for M10 cable lug	
<b>PE connection</b>		M6 screw	M8 screw	M8 screw	M8 screw	
<b>Cable length, max.</b> between output reactor and motor						
• 380 V -10 % ... 415 V +10 % 3 AC						
- Shielded	m (ft)	200 (656)	200 (656)	300 (984)	300 (984)	
- Unshielded	m (ft)	300 (984)	300 (984)	450 (1476)	450 (1476)	
• 440 ... 480 V 3 AC +10 %						
- Shielded	m (ft)	200 (656)	200 (656)	300 (984)	300 (984)	
- Unshielded	m (ft)	300 (984)	300 (984)	450 (1476)	450 (1476)	
<b>Dimensions</b>						
• Width	mm (in)	270 (10.63)	350 (13.78)	300 (11.81)	300 (11.81)	
• Height	mm (in)	248 (9.76)	321 (12.64)	285 (11.22)	315 (12.40)	
• Depth	mm (in)	209 (8.23)	288 (11.34)	257 (10.12)	277 (10.91)	
<b>Possible as base component</b>		No	No	No	No	
<b>Degree of protection</b>		IP00	IP00	IP00	IP00	
<b>Weight, approx.</b>		kg (lb)	27 (59.5)	57 (126)	60 (132)	66 (146)
<b>Suitable for SINAMICS G120C</b>		Type	6SL3210-1KE24-4.F1 6SL3210-1KE26-0.F1 6SL3210-1KE27-0.F1	FSD 6SL3210-1KE28-4.F1 FSE 6SL3210-1KE31-1.F1 FSF 6SL3210-1KE31-4.F1 6SL3210-1KE31-7.F1	6SL3210-1KE32-1.F1	6SL3210-1KE32-4.F1
• Frame size		FSD	FSD/FSE/FSF	FSF	FSF	

<sup>1)</sup> On the rating plate of the reactor, the current is specified according to the duty cycle for high overload (HO). This is lower than the current specified according to the duty cycle for low overload (LO) of the SINAMICS G120C converter.

## SINAMICS G120C compact converters

0.55 kW to 132 kW (0.75 hp to 150 hp)

### Supplementary system components > Operator panels

#### Overview

Operator panel	IOP-2 and IOP-2 Handheld Intelligent Operator Panel	BOP-2 Basic Operator Panel
Description		
	<p>Thanks to the high-contrast color display, menu-based operation and the wizards, commissioning of the standard drives is easy. Application wizards guide the user through the commissioning of important applications such as pumps, fans, compressors, or conveyor systems.</p>	<p>Commissioning of standard drives is easy with the menu-prompted dialog on a 2-line display. Simultaneous display of the parameter and parameter value, as well as parameter filtering, means that basic commissioning of a drive can be performed easily and, in most cases, without a printed parameter list.</p>
Possible applications	<ul style="list-style-type: none"> <li>• Can be mounted directly on the converter</li> <li>• Can be mounted in a control cabinet door using a door mounting kit (achievable degree of protection is IP55/UL Type 12 enclosure)</li> <li>• The environmental class/harmful chemical substances of the BOP-2 is Class 3C3 acc. to IEC 60721-3-3: 2002.</li> <li>• Available as handheld version</li> <li>• The following languages are integrated in the IOP-2: English, German, French, Italian, Spanish, Portuguese, Dutch, Swedish, Finnish, Russian, Czech, Polish, Turkish, Chinese Simplified</li> </ul>	<ul style="list-style-type: none"> <li>• Can be mounted directly on the converter</li> <li>• Can be mounted in a control cabinet door using a door mounting kit (achievable degree of protection is IP55/UL Type 12)</li> <li>• The environmental class/harmful chemical substances of the BOP-2 is Class 3C3 acc. to IEC 60721-3-3: 2002.</li> </ul>
Quick commissioning without expert knowledge	<ul style="list-style-type: none"> <li>• Standard commissioning using the clone function</li> <li>• For quicker access, the parameter block names can be directly entered respectively changed on the IOP-2 using the virtual keyboard.</li> <li>• User-defined parameter list with a reduced number of self-selected parameters</li> <li>• Simple commissioning of standard applications using application-specific wizards; it is not necessary to know the parameter structure</li> <li>• Simple local commissioning using the handheld version</li> <li>• Commissioning is possible largely without documentation</li> </ul>	<ul style="list-style-type: none"> <li>• Standard commissioning using the clone function</li> </ul>
High degree of operator friendliness and intuitive operation	<ul style="list-style-type: none"> <li>• Intuitive navigation by operating with a sensor control field</li> <li>• Graphic color display to show status values such as pressure or flow rate in the form of scalar values, bar-type diagrams, or trend displays</li> <li>• Status display with freely selectable units to specify physical values</li> <li>• Direct manual operation of the drive – you can simply toggle between the automatic and manual modes</li> <li>• Simple cloning of specific settings of the IOP-2 user interface.</li> </ul>	<ul style="list-style-type: none"> <li>• 2-line display for showing up to 2 process values with text</li> <li>• Status display of predefined units</li> <li>• Direct manual operation of the drive – you can simply toggle between the automatic and manual modes</li> </ul>
Minimization of maintenance times	<ul style="list-style-type: none"> <li>• Diagnostics using plain text display, can be used locally on-site without documentation</li> <li>• The support function is used to determine the drive data for the Power Module, Control Unit and IOP-2 and makes this available as a two-dimensional code (data matrix/QR code)</li> <li>• Easily upgradable to new functional status via USB interface</li> </ul>	<ul style="list-style-type: none"> <li>• Diagnostics with menu prompting with 7-segment display</li> </ul>



### Overview

#### IOP-2 Intelligent Operator Panel



IOP-2 Intelligent Operator Panel

The Intelligent Operator Panel IOP-2 is a very user-friendly and powerful operator panel for the SINAMICS G120, SINAMICS G120C, SINAMICS G120P, SINAMICS G120X, SINAMICS G120D, and SIMATIC ET 200pro FC-2.

The IOP-2 supports both newcomers and drive experts. Thanks to the membrane keyboard with a central sensor control field, high-contrast color displays, menu-based operation, and simple setup processes for which no specialized drive know-how is required, commissioning of drives is easy. The IOP-2 update (V2.3 and higher) offers a new concept for faster and simpler commissioning of the drive.

Within minutes, Quick Startup provides an overview of the basic parameters needed to commission and operate the drive. Advanced Startup supports simpler commissioning of more complex applications and displays the parameters in a single screen so that you no longer have to switch between the different areas in the IOP-2.

Advanced Setup generates a checklist of categories that guides the user by changing the status icons of categories when they are changed. Also, a drive can essentially be commissioned without having to use a printed parameter list because the parameters are displayed in plain text and explanatory help texts and parameter filtering function are provided.

Two process values can be graphically visualized and four process values can be numerically visualized on the status screen. Process values can also be displayed in technological units.

The IOP-2 supports standard commissioning of identical drives. For this purpose, a parameter list can be copied from a converter into the IOP-2 and downloaded into other drive units of the same type as required.

The IOP-2 can be installed in control cabinet doors using the optionally available door mounting kit.

#### Updating the IOP-2

The IOP-2 can be updated and expanded using the integrated USB interface.

Data to support future drive systems can be transferred from the PC to the IOP-2. Further, the USB interface allows user languages and wizards that will become available in the future to be subsequently downloaded and the firmware to be updated for the IOP-2<sup>1)</sup>.

The IOP-2 is supplied with power via the USB interface during an update.

#### IOP-2 Handheld



IOP-2 Handheld

A handheld version of the IOP-2 can be ordered for mobile use. In addition to the IOP-2, it includes a housing with rechargeable batteries, a charging unit, an RS232 connecting cable, and a USB cable. The charging unit is supplied with connector adapters for Europe, the US and UK. When the batteries are fully charged, the operating time is up to 10 hours.

To connect the IOP-2 Handheld to SINAMICS G120D and SIMATIC ET 200pro FC-2, the RS232 connecting cable with optical interface is required in addition.

<sup>1)</sup> Information about updates for the IOP-2 is available at <https://support.industry.siemens.com/cs/document/67273266>

## SINAMICS G120C compact converters

0.55 kW to 132 kW (0.75 hp to 150 hp)

### Supplementary system components > IOP-2 Intelligent Operator Panel

#### Selection and ordering data

Description	Article No.
<b>IOP-2 Intelligent Operator Panel</b> for use in combination with SINAMICS G120 SINAMICS G120C SINAMICS G120P SINAMICS G120X SINAMICS G120D SIMATIC ET 200pro FC-2  Operating languages: English, German, French, Italian, Spanish, Portuguese, Dutch, Swedish, Finnish, Russian, Czech, Polish, Turkish, Chinese Simplified	<b>6SL3255-0AA00-4JA2</b>
<b>IOP-2 Handheld</b> for use in combination with SINAMICS G120 SINAMICS G120C SINAMICS G120P SINAMICS G120X SINAMICS G120D SIMATIC ET 200pro FC-2  Included in the scope of delivery: <ul style="list-style-type: none"> <li>• IOP-2</li> <li>• Handheld housing</li> <li>• Rechargeable batteries (4 × AA)</li> <li>• Charging unit (international)</li> <li>• RS232 connecting cable <sup>1)</sup> 3 m (9.84 ft) long, can be used in combination with SINAMICS G120 SINAMICS G120C SINAMICS G120P SINAMICS G120X</li> <li>• USB cable 1 m (3.28 ft) long</li> </ul>	<b>6SL3255-0AA00-4HA1</b>
<b>Accessories</b>	
<b>Door mounting kit</b> For mounting an operator panel in control cabinet doors with sheet steel thicknesses of 1 ... 3 mm (0.04 in ... 0.12 in) Degree of protection IP55 Included in the scope of delivery: <ul style="list-style-type: none"> <li>• Seal</li> <li>• Mounting material</li> <li>• Connecting cable 5 m (16.4 ft) long, also supplies voltage to the IOP-2 directly via the converter</li> </ul>	<b>6SL3256-0AP00-0JA0</b>
<b>RS232 connecting cable</b> 2.5 m (8.20 ft) long, with optical interface for connecting the IOP-2 Handheld to SINAMICS G120D SIMATIC ET 200pro FC-2	<b>3RK1922-2BP00</b>

#### Benefits

- New device design
  - Intuitive user interface – membrane keyboard with central sensor control field
  - High-contrast color display with a range of display options
  - IOP-2 device design open for future functional expansions (e.g. device functions, commissioning setups, languages)
  - Easily upgradable to new functional status via USB interface
- Commissioning
  - Simple commissioning using Quick Startup and Advanced Startup
  - Quick Startup gives the user simple and fast access to all the basic parameters required to commission simple applications.
  - Advanced Startup provides the parameters required to commission more complex applications, dispensing with the need to switch between different areas within the IOP-2.
  - I/O Setup supports fast and simple configuration of digital and analog inputs and outputs.
  - Fieldbus Setup is provided for simple configuration of Ethernet/IP and PROFINET interface protocols.
  - Fast standard commissioning of converters thanks to cloning function
  - For quicker access, the parameter block names can be directly entered or changed on the IOP-2 via the virtual keyboard. Extended help functions provide support for the user during commissioning.
  - Simple local commissioning on-site using the handheld version
- Operator control and monitoring
  - Simple, individual local drive control (start/stop, setpoint value specification, change in direction of rotation)
  - Application-specific scenarios such as operator concepts with additional external operating elements can be implemented easily
  - Simple cloning of specific settings of the IOP-2 user interface, such as status screen, language settings, lighting duration, date/time settings, parameter backup mode and “My Parameters” – settings made once can such be easily transferred to many further IOP-2 Intelligent Operator Panels
- Diagnostics
  - Rapid diagnostics thanks to on-site plain text display
  - Integrated plain text help function for local display and resolution of fault messages
- Support function
  - Used to determine the drive data for the Power Module, Control Unit and IOP-2 (article number, serial number, firmware version, error statuses) and makes this available as a two-dimensional code (data matrix/QR code)
  - Allows easy contact with Customer Support via a data matrix/QR code generated on the IOP-2
  - Quick access via mobile devices (e.g. smartphones, tablets) to product information, documentation, FAQs, contact persons via a two-dimensional code generated on the IOP-2 (data matrix/QR code)
  - Scanning and evaluating of the two-dimensional data matrix code using the Industry Online Support app (<https://support.industry.siemens.com/cs/ww/en/sc/2067>), see also: <https://support.industry.siemens.com/cs/document/109748340>

<sup>1)</sup> For use in conjunction with SINAMICS G120D and SIMATIC ET 200pro FC-2, the RS232 connecting cable with optical interface is required (Article No.: **3RK1922-2BP00**). The cable must be ordered separately.

# SINAMICS G120C compact converters

0.55 kW to 132 kW (0.75 hp to 150 hp)

## Supplementary system components > IOP-2 Intelligent Operator Panel

### Integration

#### Using the IOP-2 with the converters

	<ul style="list-style-type: none"> <li>• SINAMICS G120 with CU230P-2, CU240E-2 or CU250S-2</li> <li>• SINAMICS G120C</li> <li>• SINAMICS G120P with CU230P-2</li> <li>• SINAMICS G120X</li> </ul>	<ul style="list-style-type: none"> <li>• SINAMICS G120D</li> <li>• SIMATIC ET 200pro FC-2</li> </ul>
<b>Plugging the IOP-2 onto the converter</b> (Voltage supply via converter)	✓	–
<b>Door mounting of the IOP-2 with the door mounting kit</b> (Voltage supply via converter. For this purpose, the IOP-2 must be connected up by means of the connecting cable supplied with the door mounting kit.)	✓	–
<b>Mobile use of the IOP-2 Handheld</b> (supplied from rechargeable batteries)	✓	✓ (RS232 connecting cable with optical interface required, article number 3RK1922-2BP00)

#### Door mounting

Using the optionally available door mounting kit, an operator panel can be simply mounted in a control cabinet door with just a few manual operations. In the case of door mounting, the IOP-2 Operator Panel achieves degree of protection IP55/UL Type 12 enclosure.

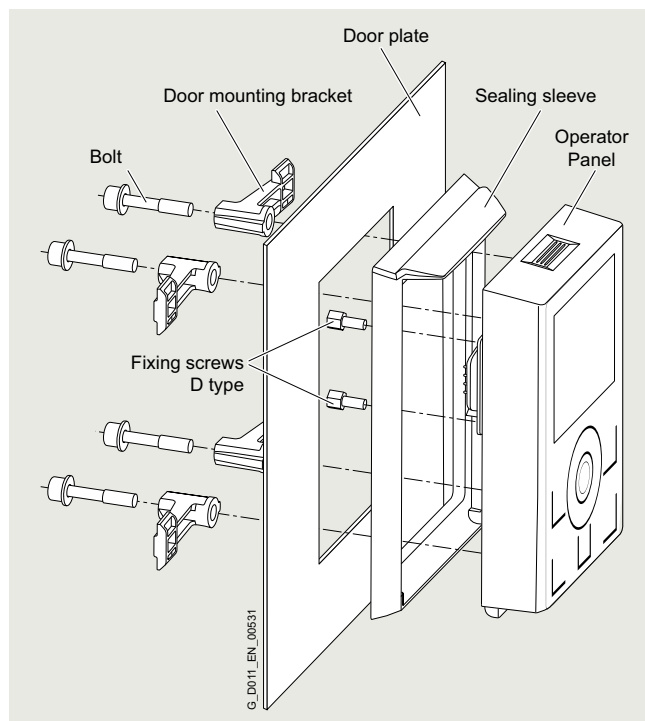

Door mounting kit with plugged-on IOP-2

### Technical specifications

	IOP-2 6SL3255-0AA00-4JA2	IOP-2 Handheld 6SL3255-0AA00-4HA1		
<b>Display</b>	High-contrast color display, a variety of display options			
• Resolution	320 × 240 pixels			
<b>Operator panel</b>	Membrane keyboard with central sensor control field			
<b>Operating languages</b>	English, German, French, Italian, Spanish, Portuguese, Dutch, Swedish, Finnish, Russian, Czech, Polish, Turkish, Chinese Simplified			
<b>Ambient temperature</b>	<ul style="list-style-type: none"> <li>• During storage and transport: -40 ... +70 °C (-40 ... +158 °F)</li> <li>• During operation:           <table border="0"> <tr> <td>For direct mounting on the converter: 0 ... 50 °C (32 ... 122 °F)</td> <td>For installation with door mounting kit: 0 ... +55 °C (32 ... 131 °F)</td> </tr> </table> </li> </ul>		For direct mounting on the converter: 0 ... 50 °C (32 ... 122 °F)	For installation with door mounting kit: 0 ... +55 °C (32 ... 131 °F)
For direct mounting on the converter: 0 ... 50 °C (32 ... 122 °F)	For installation with door mounting kit: 0 ... +55 °C (32 ... 131 °F)			
<b>Humidity</b>	Relative humidity < 95 %, non-condensing			
<b>Degree of protection</b>	For direct mounting on the converter: IP20 For installation with door mounting kit: IP55, UL Type 12 enclosure	IP20		
<b>Dimensions (H × W × D)</b>	106.86 × 70 × 19.65 mm (4.21 × 2.76 × 0.77 in)	195.04 × 70 × 37.58 mm (7.68 × 2.76 × 1.48 in)		
<b>Weight, approx.</b>	0.134 kg (0.3 lb)	0.724 kg (1.6 lb)		
<b>Compliance with standards</b>	CE, UKCA, RCM, cULus, EAC, KC-REM-S49-SINAMICS			
<b>Environmental class in operation</b>	Harmful chemical substances Class 3C3 acc. to IEC 60721-3-3: 2002			

## SINAMICS G120C compact converters

0.55 kW to 132 kW (0.75 hp to 150 hp)

### Supplementary system components > BOP-2 Basic Operator Panel

#### Overview



BOP-2 Basic Operator Panel

The BOP-2 Basic Operator Panel can be used to commission drives, monitor drives in operation and input individual parameter settings.

Commissioning of standard drives is easy with the menu-prompted dialog on a 2-line display. Simultaneous display of the parameter and parameter value, as well as parameter filtering, means that basic commissioning of a drive can be performed easily and, in most cases, without a printed parameter list.

The drives are easily controlled manually using directly assigned navigation buttons. The BOP-2 has a dedicated switchover button to switch from automatic to manual mode.

Diagnostics can easily be performed on the connected converter by following the menus.

Up to two process values can be numerically visualized simultaneously.

BOP-2 supports standard commissioning of identical drives. For this purpose, a parameter list can be copied from a converter into the BOP-2 and when required, downloaded into other drive units of the same type.

The operating temperature of the BOP-2 is 0 °C ... 50 °C (32 °F ... 122 °F).

The environmental class/harmful chemical substances of the BOP-2 is Class 3C3 acc. to IEC 60721-3-3: 2002.

#### Selection and ordering data

Description	Article No.
<b>BOP-2 Basic Operator Panel</b>	<b>6SL3255-0AA00-4CA1</b>
<b>Accessories</b>	
<b>Door mounting kit</b>	<b>6SL3256-0AP00-0JA0</b>
For mounting an operator panel in control cabinet doors with sheet steel thicknesses of 1 ... 3 mm (0.04 in ... 0.12 in) Degree of protection IP55	
Included in the scope of delivery:	
<ul style="list-style-type: none"> <li>• Seal</li> <li>• Mounting material</li> <li>• Connecting cable (5 m/16.4 ft) long, also supplies voltage to the operator panel directly via the converter)</li> </ul>	

#### Benefits

- Shorten commissioning times – Easy commissioning of standard drives using basic commissioning wizards (setup)
- Minimize standstill times – Fast detection and rectification of faults (Diagnostics)
- Greater transparency in the process – The status display of the BOP-2 makes process variable monitoring easy (Monitoring)
- Direct mounting on the converter ([see also IOP-2](#))
- User-friendly user interface:
  - Easy navigation using clear menu structure and clearly assigned control keys
  - Two-line display

## SINAMICS G120C compact converters

0.55 kW to 132 kW (0.75 hp to 150 hp)

### Supplementary system components > Memory cards

#### Overview



SINAMICS SD memory card

The parameter settings for a converter can be stored on the SINAMICS SD memory card. When service is required, e.g. after the converter has been replaced and the data have been downloaded from the memory card, the drive system is immediately ready for use again.

- Parameter settings can be written from the memory card to the converter or saved from the converter to the memory card.
- Up to 100 parameter sets can be stored.
- The memory card supports standard commissioning without the use of an operator panel such as the IOP-2, BOP-2 or the STARTER and SINAMICS Startdrive commissioning tools.
- If firmware is stored on the memory card and a frequency converter is installed, the firmware can be upgraded/downgraded during converter startup <sup>1)</sup>.

#### Note:

The memory card is not required for operation and does not have to remain inserted.

#### Selection and ordering data

Description	Article No.
<b>SINAMICS SD card 512 MB</b>	<b>6SL3054-4AG00-2AA0</b>
<i>Optional firmware memory cards</i>	
<b>SINAMICS SD card 512 MB + firmware V4.7 SP13</b> (Multicard V4.7 SP13)	<b>6SL3054-7TG00-2BA0</b>
<b>SINAMICS SD card 512 MB + firmware V4.7 SP14</b> (Multicard V4.7 SP14)	<b>6SL3054-7TH00-2BA0</b>

More information on firmware V4.7 SP14:

<https://support.industry.siemens.com/cs/document/109817231>

For an overview and more information on all available firmware versions, see

<https://support.industry.siemens.com/cs/document/67364620>

#### Notes:

SINAMICS G120C compact converters with frame size FSAA can be operated as of firmware V4.7 SP3.

SINAMICS G120C compact converters with frame sizes FSD to FSF can be operated as of firmware V4.7 SP6.

<sup>1)</sup> You can find more information about firmware upgrades/downgrades on the internet at <https://support.industry.siemens.com/cs/document/67364620>

## SINAMICS G120C compact converters

0.55 kW to 132 kW (0.75 hp to 150 hp)

Supplementary system components > SINAMICS G120 Smart Access

### Overview



SINAMICS G120 Smart Access

It is also easy and convenient to commission and operate the SINAMICS G115D, SINAMICS G120, SINAMICS G120C, SINAMICS G120P and SINAMICS G120X frequency converters of firmware V4.7 SP6 and higher using the web server module SINAMICS G120 Smart Access and a connected smartphone, tablet or laptop.

### Benefits

- Wireless commissioning, operation and diagnostics via mobile device or laptop thanks to the optional SINAMICS G120 Smart Access
- Intuitive user interface and commissioning wizard
- Free choice of terminal devices as the web server works with all common web browsers, such as iOS, Android, Microsoft Windows, Linux and Mac OS

### Function

- Commissioning using commissioning wizard
- Setting and saving parameters
- Testing motor in JOG mode
- Monitoring of converter data
- Quick diagnostics
- Saving the settings and restoring to factory settings

### Integration



SINAMICS G120C with plugged-on SINAMICS G120 Smart Access

The optional SINAMICS G120 Smart Access is simply plugged onto the converter and is available for the following converters of firmware V4.7 SP6 and higher.

- SINAMICS G115D together with the interface kit for SINAMICS G120 Smart Access
- SINAMICS G120C
- SINAMICS G120 together with the CU230P-2 and CU240E-2 Control Units (without fail-safe versions)
- SINAMICS G120P together with the CU230P-2 Control Units
- SINAMICS G120X

## SINAMICS G120C compact converters

0.55 kW to 132 kW (0.75 hp to 150 hp)

### Supplementary system components > SINAMICS G120 Smart Access

#### Selection and ordering data

Description	Article No.
<p><b>SINAMICS G120 Smart Access</b> For wireless commissioning, operation and diagnostics of the following converters using a smartphone, tablet, or laptop</p> <ul style="list-style-type: none"> <li>• SINAMICS G115D together with the interface kit for SINAMICS G120 Smart Access</li> <li>• SINAMICS G120C</li> <li>• SINAMICS G120 together with the CU230P-2 and CU240E-2 Control Units (without fail-safe versions)</li> <li>• SINAMICS G120P together with the CU230P-2 Control Units</li> <li>• SINAMICS G120X</li> </ul>	<b>6SL3255-0AA00-5AA0</b>

#### Technical specifications

	<b>SINAMICS G120 Smart Access</b> 6SL3255-0AA00-5AA0
<b>Operating system</b>	iOS, Android, Microsoft Windows, Linux, Mac OS
<b>Languages</b>	Support of six languages: English, French, German, Italian, Spanish, Chinese
<b>Ambient temperature</b>	
• During storage and transport	-40 ... +70 °C (-40 ... +158 °F)
• During operation	0 ... 50 °C (32 ... 122 °F) if the Smart Access is plugged directly into the converter
<b>Humidity</b>	< 95 %, non-condensing
<b>Degree of protection</b>	Depending on the degree of protection of the converter, max. IP55/UL Type 12 enclosure
<b>Dimensions</b>	
• Width	70 mm (2.76 in)
• Height	108.9 mm (4.29 in)
• Depth	17.3 mm (0.68 in)
<b>Weight, approx.</b>	0.08 kg (0.18 lb)
<b>Compliance with standards</b>	CE, UKCA, FCC, SRRG, WPC, ANATEL, BTK

## SINAMICS G120C compact converters

0.55 kW to 132 kW (0.75 hp to 150 hp)

### Supplementary system components > PC converter connection kit 2

#### Overview



PC converter connection kit 2

For controlling and commissioning a converter directly from a PC if a commissioning tool (e.g. SINAMICS Startdrive) has been installed on the PC. With this, the converter can be

- parameterized (commissioning, optimization),
- monitored (diagnostics)
- controlled (master control via the STARTER or SINAMICS Startdrive commissioning tool for test purposes)

A USB cable (3 m/9.84 ft) is included in the scope of delivery.

#### Selection and ordering data

Description	Article No.
<b>PC converter connection kit 2</b> USB cable (3 m/9.84 ft long) for <ul style="list-style-type: none"> <li>• SINAMICS G120C</li> <li>• SINAMICS G120 Control Units               <ul style="list-style-type: none"> <li>- CU230P-2</li> <li>- CU240E-2</li> <li>- CU250S-2</li> </ul> </li> <li>• SINAMICS G115D</li> <li>• SINAMICS G120D Control Units               <ul style="list-style-type: none"> <li>- CU240D-2</li> <li>- CU250D-2</li> </ul> </li> </ul>	<b>6SL3255-0AA00-2CA0</b>

8

### Supplementary system components > Shield connection kits

#### Overview

A shield connection kit is supplied as standard with frame sizes FSAA to FSC. A set of shield plates is included in the scope of delivery for the motor and signal cables corresponding to the frame size for the frame sizes FSD to FSF. For the electromagnetically compatible connection of an optionally connectable braking resistor, the corresponding shield connection kit is to be ordered for frame sizes FSD to FSF.

#### Selection and ordering data

Description	Article No.
<b>Shield connection kit for SINAMICS G120C</b> <ul style="list-style-type: none"> <li>• Frame sizes FSAA to FSC</li> </ul>	Supplied with the converter, available as a spare part
<ul style="list-style-type: none"> <li>• Frame sizes FSD to FSF                A set of shield plates is included in the scope of delivery for the motor and signal cables corresponding to the frame size. For the electromagnetically compatible connection of an optionally connectable braking resistor, the corresponding shield connection kit is to be ordered.             </li> <li>- Frame size FSD</li> <li>- Frame size FSE</li> <li>- Frame size FSF</li> </ul>	<b>6SL3262-1AD01-0DA0</b> <b>6SL3262-1AE01-0DA0</b> <b>6SL3262-1AF01-0DA0</b>



## SINAMICS G120C compact converters

0.55 kW to 132 kW (0.75 hp to 150 hp)

### Spare parts

#### Overview

The following spare parts are available for SINAMICS G120C for service and maintenance work.

#### **SINAMICS G120C shield connection kits**

A shield connection kit is supplied as standard with frame sizes FSAA to FSC.

A set of shield plates is included in the scope of delivery for the motor and signal cables corresponding to the frame size for the frame sizes FSD to FSF. For the electromagnetically compatible connection of an optionally connectable braking resistor, the corresponding shield connection kit is to be ordered for frame sizes FSD to FSF.

#### **SINAMICS G120C spare parts kit**

This kit comprises 4 I/O terminals, 1 RS485 terminal, 2 sets of Control Unit doors (1 × PN and 1 × other communication versions) and 1 blanking cover.

#### **SINAMICS terminal cover kit**

The terminal cover kit includes a replacement cover for the connecting terminals.

Terminal cover kits, which are suitable for frame sizes FSD to FSF, are available.

#### **SINAMICS G120C connectors**

A set of connectors for the line feeder cable, braking resistor and motor cable can be ordered corresponding to the frame size of the SINAMICS G120C compact converter for the frame sizes FSAA to FSC.

#### **SINAMICS G120C roof-mounted fan**

A roof-mounted fan (at the top of the device) comprising a pre-assembled unit with holder and fan can be ordered corresponding to the frame size of the SINAMICS G120C compact converter.



SINAMICS G120C frame size FSB, with integrated roof-mounted fan

#### **SINAMICS G120C fan unit**

A replacement fan (at the rear of the device; heat sink) comprising a pre-assembled unit with holder and fan can be ordered corresponding to the frame size of the SINAMICS G120C compact converter.



SINAMICS G120C frame size FSB, with fan unit (rear view of rotated converter)

#### Selection and ordering data

Description	Article No.
<b>SINAMICS G120C shield connection kit</b>	
• Frame size FSAA	6SL3266-1ER00-0KA0
• Frame size FSA	6SL3266-1EA00-0KA0
• Frame size FSB	6SL3266-1EB00-0KA0
• Frame size FSC	6SL3266-1EC00-0KA0
• Frame size FSD	6SL3262-1AD01-0DA0
• Frame size FSE	6SL3262-1AE01-0DA0
• Frame size FSF	6SL3262-1AF01-0DA0
<b>SINAMICS G120C spare parts kit</b>	
• Frame sizes FSAA to FSC	6SL3200-0SK41-0AA0
• Frame sizes FSD to FSF	6SL3200-0SK08-0AA0
<b>SINAMICS terminal cover kit</b>	
• Frame size FSD	6SL3200-0SM13-0AA0
• Frame size FSE	6SL3200-0SM14-0AA0
• Frame size FSF	6SL3200-0SM15-0AA0
<b>SINAMICS G120C connectors</b>	
• Frame sizes FSAA and FSA	6SL3200-0ST05-0AA0
• Frame size FSB	6SL3200-0ST06-0AA0
• Frame size FSC	6SL3200-0ST07-0AA0
<b>SINAMICS G120C roof-mounted fan</b>	
• Frame size FSAA	6SL3200-0SF38-0AA0
• Frame size FSA	6SL3200-0SF40-0AA0
• Frame size FSB	6SL3200-0SF41-0AA0
• Frame size FSC	6SL3200-0SF42-0AA0
<b>SINAMICS G120C fan unit</b>	
• Frame size FSA	6SL3200-0SF12-0AA0
• Frame size FSB	6SL3200-0SF13-0AA0
• Frame size FSC	6SL3200-0SF14-0AA0
• Frame size FSD	6SL3200-0SF15-0AA0
• Frame size FSE	6SL3200-0SF16-0AA0
• Frame size FSF	6SL3200-0SF17-0AA0

## SINAMICS G120C compact converters

### Notes

## SINAMICS G120 standard converters

### 0.37 kW to 250 kW (0.5 hp to 400 hp)



#### 9/2 Introduction

- 9/2 Application
- 9/2 More information

#### 9/3 SINAMICS G120 standard converters

- 9/3 Overview
- 9/5 Benefits
- 9/5 Design
- 9/13 Configuration
- 9/14 Technical specifications

#### 9/17 Control Units

- 9/17 Overview
- 9/20 Design
- 9/24 Function
- 9/26 Integration
- 9/30 Selection and ordering data
- 9/33 Technical specifications

#### 9/36 Power Modules

- 9/36 Overview
- 9/38 Integration
- 9/42 Selection and ordering data
- 9/45 Technical specifications
- 9/62 Characteristic curves
- 9/67 Dimensional drawings

#### 9/69 Line-side components

- 9/69 Line filters
- 9/72 Line Harmonics Filter
- 9/76 Line reactors
- 9/79 Recommended line-side overcurrent protection devices

#### 9/82 DC link components

- 9/82 Braking resistors

#### 9/88 Load-side power components

- 9/88 Output reactors
- 9/96 Sine-wave filters
- 9/101 dv/dt filters plus VPL

#### 9/105 Supplementary system components

- 9/105 Operator panels
- 9/106 IOP-2 Intelligent Operator Panel
- 9/109 BOP-2 Basic Operator Panel
- 9/111 Memory cards
- 9/112 SINAMICS G120 Smart Access
- 9/113 Brake Relay
- 9/114 Safe Brake Relay for blocksize format
- 9/115 SINAMICS CUA20 Control Unit Adapter
- 9/115 PC converter connection kit 2
- 9/116 Shield connection kits for Control Units
- 9/116 Shield connection kits for Power Modules
- 9/117 Wiring adapter for frame size FSG

#### 9/118 Spare parts

- 9/118 Spare parts kit for Control Units
- 9/118 Shield connection kits for PM240-2 Power Modules
- 9/118 Small parts assembly set for frame sizes FSD to FSG
- 9/119 Terminal cover kits for frame sizes FSD to FSG
- 9/119 Replacement connectors
- 9/120 Fan units
- 9/122 Replacement fans

## SINAMICS G120 standard converters

0.37 kW to 250 kW (0.5 hp to 400 hp)

### Introduction

### Application

Use	Requirements for torque accuracy/speed accuracy/position accuracy/coordination of axes/functionality					
	Continuous motion			Non-continuous motion		
	Basic	Medium	High	Basic	Medium	High
<b>Pumping, ventilating, compressing</b> 	Centrifugal pumps Radial/axial fans Compressors	Centrifugal pumps Radial/axial fans Compressors	Eccentric screw pumps	Hydraulic pumps Metering pumps	Hydraulic pumps Metering pumps	Descaling pumps Hydraulic pumps
	V20 G120C G120X	G120X G130/G150 G180 <sup>1)</sup> DCM	S120	<b>G120</b>	S110	S120
<b>Moving</b> 	Conveyor belts Roller conveyors Chain conveyors	Conveyor belts Roller conveyors Chain conveyors Lifting/lowering devices Elevators Escalators/moving walkways Indoor cranes Marine drives Cable railways	Elevators Container cranes Mining hoists Excavators for open-cast mining Test bays	Acceleration conveyors Storage and retrieval machines	Acceleration conveyors Storage and retrieval machines Cross-cutters Reel changers	Storage and retrieval machines Robotics Pick & place Rotary indexing tables Cross-cutters Roll feeds Engagers/disengagers
	V20 G115D G120C ET 200pro FC-2 <sup>2)</sup>	<b>G120</b> G120D G130/G150 G180 <sup>1)</sup>	S120 S150 DCM	V90 <b>G120</b> G120D	S110 S210 DCM	S120 S210 DCM
<b>Processing</b> 	Mills Mixers Kneaders Crushers Agitators Centrifuges	Mills Mixers Kneaders Crushers Agitators Centrifuges Extruders Rotary furnaces	Extruders Winders/unwinders Lead/follower drives Calenders Main press drives Printing machines	Tubular bagging machines Single-axis motion control such as • Position profiles • Path profiles	Tubular bagging machines Single-axis motion control such as • Position profiles • Path profiles	Servo presses Rolling mill drives Multi-axis motion control such as • Multi-axis positioning • Cams • Interpolations
	V20 G120C	<b>G120</b> G130/G150 G180 <sup>1)</sup>	S120 S150 DCM	V90 <b>G120</b>	S110 S210	S120 S210 DCM
<b>Machining</b> 	Main drives for • Turning • Milling • Drilling	Main drives for • Drilling • Sawing	Main drives for • Turning • Milling • Drilling • Gear cutting • Grinding	Axis drives for • Turning • Milling • Drilling	Axis drives for • Drilling • Sawing	Axis drives for • Turning • Milling • Drilling • Lasering • Gear cutting • Grinding • Nibbling and punching
	S110	S110 S120	S120	S110	S110 S120	S120

The standard SINAMICS G120 converter is especially well-suited

- as a universal drive in all industrial and commercial applications
- e.g. in the automotive, textile, process technology industries
- for higher-level applications such as, for example, conveyor systems in the steel, oil, gas and offshore sectors, or in regenerative energy recovery applications.

Practical application examples and descriptions are available on the internet at

[www.siemens.com/sinamics-applications](http://www.siemens.com/sinamics-applications)

### More information

You may also be interested in these frequency converters:

- Higher degree of protection for power ratings up to 7.5 kW ⇒ SINAMICS G115D, SINAMICS G120D (Catalog D 31.2)
- With positioning function for distributed drive solutions in IP65 degree of protection ⇒ SINAMICS G120D (Catalog D 31.2)
- With positioning function in the control cabinet in IP20 degree of protection ⇒ SINAMICS S110
- For HVAC, water and waste water applications in the infrastructure sector for power range 0.75 kW to 630 kW ⇒ SINAMICS G120X (Catalog D 31.5)

<sup>1)</sup> Industry-specific converters.

<sup>2)</sup> Information on the SIMATIC ET 200pro FC-2 frequency converter is available in Catalog D 31.2 and at: [www.siemens.com/et200pro-fc](http://www.siemens.com/et200pro-fc)

## SINAMICS G120 standard converters

0.37 kW to 250 kW (0.5 hp to 400 hp)

### SINAMICS G120 standard converters

#### Overview

The SINAMICS G120 frequency converter is designed to provide precise and cost-effective speed/torque control of three-phase motors.

With different device versions (frame sizes FSA to FSG) in a power range from 0.37 kW to 250 kW, it is suitable for a wide variety of drive solutions.



Example: SINAMICS G120, frame sizes FSA, FSB and FSC; each with Power Module, CU240E-2 F Control Unit and Basic Operator Panel BOP-2

#### Operator-friendly design

SINAMICS G120 is a modular converter system that essentially comprises two function units:

- Control Unit (CU)
- Power Module (PM)

The Control Unit controls and monitors the Power Module and the connected motor using several different closed-loop control types that can be selected. It supports communication with a local or central controller and monitoring devices.

The Power Module supplies the motor in the power range 0.37 kW to 250 kW. It features state-of-the-art IGBT technology with pulse-width-modulated motor voltage and selectable pulse frequency. Comprehensive protection functions provide a high degree of protection for the Power Module and the motor.

The Control Units can be combined with the following Power Modules:

Control Units	Power Modules degree of protection IP20	
	PM240-2	PM250
CU230P-2	✓	✓
CU240E-2	✓	✓
CU250S-2	✓	✓



Example: SINAMICS G120, frame sizes FSD, FSE, FSF and FSG; each with Power Module, CU240E-2 F Control Unit and Intelligent Operator Panel IOP-2

## SINAMICS G120 standard converters

0.37 kW to 250 kW (0.5 hp to 400 hp)

### SINAMICS G120 standard converters

#### Overview

##### Safety Integrated

SINAMICS G120 standard converters are available in different versions for safety-related applications. The PM240-2 and PM250 Power Modules are already designed for Safety Integrated. A drive can be combined with a Control Unit with safety functions (see overview) in order to create a Safety Integrated drive. The availability of Safety Integrated functions depends on the type of Control Unit.

Control Unit	Basic Safety functions			Extended Safety functions		
	STO	SS1	SBC <sup>1)</sup>	SLS	SDI	SSM
<b>CU230P-2</b>	–	–	–	–	–	–
<b>CU240E-2</b>	✓	–	–	–	–	–
<b>CU240E-2 F</b>	✓	✓	–	✓	✓	✓ <sup>2)</sup>
<b>CU250S-2</b>	✓	✓	✓	✓ <sup>3)</sup>	✓ <sup>3)</sup>	✓ <sup>3)</sup>

Basic Safety functions (certified according to IEC 61508 SIL 2, and EN ISO 13849-1 PL d and Category 3)

- Safe Torque Off (STO) to protect against active movement of the drive
- The PM240-2 Power Modules, frame sizes FSD to FSG, offer additional terminals to achieve STO acc. to IEC 61508 SIL 3 and EN ISO 13489-1 PL e and Category 3.
- Safe Stop 1 (SS1) for continuous monitoring of a safe braking ramp
- Safe Brake Control (SBC) is used to safely control a holding brake. When enabled, SBC is always activated at the same time as STO. The Safe Brake Relay is used for SBC.

Extended Safety functions (certified according to IEC 61508 SIL 2 and EN ISO 13849-1 PL d and Category 3)

- Safely-Limited Speed (SLS) for protection against dangerous movements on exceeding a speed limit
- Safe Direction (SDI) This function ensures that the drive can only rotate in the selected direction.
- Safe Speed Monitor (SSM) This function signals if a drive operates below a specific speed/feed velocity.

Basic Safety and Extended Safety functions can be activated via PROFIsafe or by means of the safety inputs.

None of the safety functions require a motor encoder and they are thus cheaper and easier to implement. Existing systems in particular can be simply updated with safety technology without the need to change the motor or mechanical system.

The Safe Torque Off (STO) function can be used without restriction for all applications. The SS1, SLS, SSM and SDI functions are only permissible for applications where the load can never accelerate when the converter is switched off. They are therefore not permitted for applications involving pull-through loads such as hoisting gear and unwinders.

Further information can be found in the section [Safety Integrated](#).

##### Efficient Infeed Technology

The innovative Efficient Infeed Technology is employed in PM250 Power Modules. This technology allows the energy produced by motors operating in generator mode connected to standard converters to be fed back into the supply system. For control cabinets, an additional temperature rise can be avoided and the amount of space required can be reduced due to the fact that components such as braking resistors, braking choppers and line reactors can be eliminated. Further, wiring and engineering costs are significantly reduced. At the same time, energy consumption can be reduced and ongoing operating costs noticeably reduced.

##### Innovative cooling concept and varnishing of electronic modules

The new cooling system and varnishing of the electronic modules significantly increases the service life or useful life of the device.

- Disposal of all heat losses via an external heat sink
- Consequential convection cooling of the Control Unit, electronic modules are not located in the air duct
- All cooling air from the fan is directed through the heat sink

##### Energy efficiency

Integrated technologies help when optimizing the energy usage of the plant or system referred to the particular application:

- Energy-efficient vector control with or without sensors
- Automatic flux reduction with V/f ECO mode
- Integrated energy saving computer

Further information can be found in the section [Energy efficiency](#).

<sup>1)</sup> The SBC function can be utilized only if a Safe Brake Relay is installed.

<sup>2)</sup> SSM possible only for CU240E-2 DP-F / CU240E-2 PN-F Control Units with PROFIsafe.

<sup>3)</sup> With license for Extended Safety functions.

## SINAMICS G120 standard converters

0.37 kW to 250 kW (0.5 hp to 400 hp)

### SINAMICS G120 standard converters

#### Benefits

- Modularity ensures flexibility for a drive concept that is fit for the future
  - Control Unit can be hot-swapped
  - Pluggable terminals
  - The modules can be easily replaced, which makes the system extremely service friendly
- The integrated safety functions significantly reduce the costs when integrating drives into safety-oriented machines or systems
- The PM240-2 Power Modules, frame sizes FSD to FSG, offer additional terminals to achieve STO acc. to IEC 61508 SIL 3 and EN ISO 13489-1 PL e and Category 3.
- Communications-capable via PROFINET or PROFIBUS with PROFIdrive Profile 4.0
  - Plant-wide engineering
  - Easy to handle
- Wireless commissioning, operation and diagnostics via mobile device or laptop thanks to the optional SINAMICS G120 Smart Access
- The innovative circuit design (bidirectional input rectifier with "pared-down" DC link) allows the kinetic energy of a load to be fed back into the supply system when PM250 Power Modules are used. This feedback capability provides enormous potential for savings because generated energy no longer has to be converted into heat in a braking resistor
- Integrated USB interface for simplified, local commissioning and diagnostics
- With Control Unit CU230P-2: Application-specific functions for pumps, fans and compressors
 

Integrated are, e.g.:

  - 4 freely-programmable PID controllers
  - Application-specific wizards
  - Pt1000-/LG-Ni1000-/DIN-Ni1000 temperature sensor interface
  - 230 V AC relay
  - 3 freely-programmable digital time switches

More information can be found in [Catalog D 35](#).
- With CU250S-2 Control Units: Integrated positioning functionality (basic positioner EPos) supports process-related implementation of positioning tasks with a high dynamic response. Positioning can be implemented with an incremental and/or absolute encoder (SSI)
  - Encoder interfaces DRIVE-CLiQ, HTL/TTL/SSI (SUB-D) and resolver/HTL (terminal)
  - Vector control with or without sensors
- Integrated control functionality by using BICO technology
- An innovative cooling concept and coated electronic modules increase robustness and service life
  - External heat sink
  - Electronic components are not located in air duct
  - Control Unit that is completely cooled by convection
  - Additional coating of the most important components
- Simple unit replacement and quick copying of parameters using an optional Operator Panel or an optional memory card
- Quiet motor operation as a result of the high pulse frequency
- Compact, space-saving design
- Simple adaptation to 50 Hz or 60 Hz motors (IEC or NEMA motors)
- 2/3-wire control for static/pulsed signals for universal control via digital inputs
- Certified worldwide for compliance with CE, UKCA, UL, cUL, RCM, SEMI F47 and Safety Integrated according to IEC 61508 SIL 2 and EN ISO 13849-1 PL d and Category 3

#### Extended warranty

For SINAMICS G120, Siemens offers an optional extension of warranty up to 5½ years via **Service Protect**:

- Free for the first 6 months after registering the product: <https://myregistration.siemens.com>
- Subject to a charge for a further 3 or 5 years

For more information, go to:

<https://support.industry.siemens.com/cs/ww/de/sc/4842>

Concerning standard warranty please ask your partner at Siemens. Your partner can be found in our Personal Contacts Database at:

[www.siemens.com/automation-contact](http://www.siemens.com/automation-contact)

#### Design

##### Application-orientated design of SINAMICS G120

SINAMICS G120 standard converters are modular converters for standard drives. Selection of the SINAMICS G120 is reduced to two or three steps thanks to the modular system used.

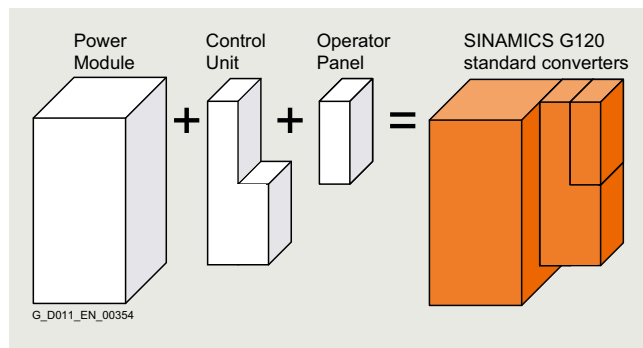

##### Selecting the Control Unit

The optimum Control Unit is selected first, based on the number of I/Os and any additional functions required such as Safety Integrated or HVAC. The communication options are already integrated and do not have to be additionally ordered or plugged in. Three product series are available corresponding to the particular application.

##### CU230P-2 Control Units

The CU230P-2 Control Units are especially designed for pump, fan, and compressor applications.

##### CU240E-2 Control Units

The CU240E-2 Control Units are suitable for a wide range of applications in general machine construction, such as conveyor belts, mixers and extruders.

##### CU250S-2 Control Units

The CU250S-2 Control Units are suitable for applications involving single drives with exacting speed control requirements such as extruders and centrifuges, and for positioning tasks such as conveyor belts, lifting/lowering devices, etc. They can also be used to implement multi-motor drives without DC coupling such as wire-drawing machines and simple material lines.

## SINAMICS G120 standard converters

0.37 kW to 250 kW (0.5 hp to 400 hp)

### SINAMICS G120 standard converters

#### Design

Designation	Fieldbus	Profile	Inputs Outputs	Integrated safety technology	Fail-safe digital inputs digital outputs	Control Unit  Article No.
<b>CU230P-2 series - the specialist for pumps, fans, compressors, water, buildings</b>						
Technology functions (selection): Free function blocks (FFB), 4 × PID controller, cascade connection, hibernation mode, essential service mode, multi-zone control						
<b>CU230P-2 HVAC</b>	<ul style="list-style-type: none"> <li>• USS</li> <li>• Modbus RTU</li> <li>• BACnet MS/TP</li> <li>• FLN P1</li> </ul>	–	6 DI 4 AI  3 DO 2 AO	–	–	<b>6SL3243-0BB30-1HA3</b>
<b>CU230P-2 DP</b>	<ul style="list-style-type: none"> <li>• PROFIBUS DP</li> </ul>	<ul style="list-style-type: none"> <li>• PROFIdrive</li> </ul>				<b>6SL3243-0BB30-1PA3</b>
<b>CU230P-2 PN</b>	<ul style="list-style-type: none"> <li>• PROFINET</li> <li>• EtherNet/IP</li> <li>- ODVA AC Drive</li> <li>- SINAMICS profile</li> </ul>	<ul style="list-style-type: none"> <li>• PROFIdrive</li> <li>• PROFInergy</li> </ul>				<b>6SL3243-0BB30-1FA0</b>
<b>CU240E-2 series – for standard applications in general machinery construction, such as conveyor belts, mixers and extruders – without encoder</b>						
Technology functions (selection): Free function blocks (FFB), 1 × PID controller, motor holding brake						
<b>CU240E-2</b>	<ul style="list-style-type: none"> <li>• USS</li> <li>• Modbus RTU</li> </ul>	–	6 DI 2 AI  3 DO 2 AO	STO	1 F-DI (opt. for each 2 DI)	<b>6SL3244-0BB12-1BA1</b>
<b>CU240E-2 DP</b>	<ul style="list-style-type: none"> <li>• PROFIBUS DP</li> </ul>	<ul style="list-style-type: none"> <li>• PROFIdrive</li> <li>• PROFIsafe</li> </ul>				<b>6SL3244-0BB12-1PA1</b>
<b>CU240E-2 PN</b>	<ul style="list-style-type: none"> <li>• PROFINET</li> <li>• EtherNet/IP</li> <li>- ODVA AC Drive</li> <li>- SINAMICS profile</li> </ul>	<ul style="list-style-type: none"> <li>• PROFIdrive</li> <li>• PROFIsafe</li> <li>• PROFInergy</li> </ul>				<b>6SL3244-0BB12-1FA0</b>
<b>CU240E-2 F</b>	<ul style="list-style-type: none"> <li>• USS</li> <li>• Modbus RTU</li> </ul>	–		STO, SS1, SLS, SDI	3 F-DI (opt. for each 2 DI)	<b>6SL3244-0BB13-1BA1</b>
<b>CU240E-2 DP-F</b>	<ul style="list-style-type: none"> <li>• PROFIBUS DP</li> </ul>	<ul style="list-style-type: none"> <li>• PROFIdrive</li> <li>• PROFIsafe</li> </ul>		STO, SS1, SLS, SSM <sup>1)</sup> , SDI		<b>6SL3244-0BB13-1PA1</b>
<b>CU240E-2 PN-F</b>	<ul style="list-style-type: none"> <li>• PROFINET</li> <li>• EtherNet/IP</li> <li>- ODVA AC Drive</li> <li>- SINAMICS profile</li> </ul>	<ul style="list-style-type: none"> <li>• PROFIdrive</li> <li>• PROFIsafe</li> <li>• PROFInergy</li> </ul>				<b>6SL3244-0BB13-1FA0</b>
<b>CU250S-2 series – for complex applications such as extruders and centrifuges – with and without encoder (basic positioner (EPos) optional)</b>						
Technology functions (selection): Free function blocks (FFB), 1 × PID controller, motor holding brake						
<b>CU250S-2</b>	<ul style="list-style-type: none"> <li>• USS</li> <li>• Modbus RTU</li> </ul>	–	11 DI 2 AI  3 DO 2 AO	STO, SBC, SS1	3 F-DI (opt. for each 2 DI)	<b>6SL3246-0BA22-1BA0</b>
<b>CU250S-2 DP</b>	<ul style="list-style-type: none"> <li>• PROFIBUS DP</li> </ul>	<ul style="list-style-type: none"> <li>• PROFIdrive</li> <li>• PROFIsafe</li> </ul>	4 DI/DO (DI can be used as high-speed inputs)		1 F-DO (opt. for each 2 DO)	<b>6SL3246-0BA22-1PA0</b>
<b>CU250S-2 PN</b>	<ul style="list-style-type: none"> <li>• PROFINET</li> <li>• EtherNet/IP</li> <li>- ODVA AC Drive</li> <li>- SINAMICS profile</li> </ul>	<ul style="list-style-type: none"> <li>• PROFIdrive</li> <li>• PROFIsafe</li> <li>• PROFInergy</li> </ul>				<b>6SL3246-0BA22-1FA0</b>
<b>CU250S-2 CAN</b>	<ul style="list-style-type: none"> <li>• CANopen</li> </ul>	–				<b>6SL3246-0BA22-1CA0</b>

<sup>1)</sup> SSM is only possible with PROFIsafe.



# SINAMICS G120 standard converters

0.37 kW to 250 kW (0.5 hp to 400 hp)

## SINAMICS G120 standard converters

### Design

#### Optional memory card with firmware V4.7 SP13 or V4.7 SP 14 for CU230P-2, CU240E-2 and CU250S-2 Control Units

Designation	Suitable for	Article No.
<b>SINAMICS SD card</b> 512 MB + firmware V4.7 SP13 (Multicard V4.7 SP13)	CU230P-2 CU240E-2 CU250S-2	<b>6SL3054-7TG00-2BA0</b>
<b>SINAMICS SD card</b> 512 MB + firmware V4.7 SP14 (Multicard V4.7 SP14)	CU230P-2 CU240E-2 CU250S-2	<b>6SL3054-7TH00-2BA0</b>

#### Optional memory cards with licenses for CU250S-2 Control Units only

Designation	SINAMICS SD card 512 MB + licenses <sup>1)</sup>	SINAMICS SD card 512 MB + firmware V4.7 SP13 (Multicard V4.7 SP13) + licenses <sup>1)</sup>	SINAMICS SD card 512 MB + firmware V4.7 SP14 (Multicard V4.7 SP14) + licenses <sup>1)</sup>	Licenses (without SD card) for upgrading license of an existing SD card <sup>2)</sup>
	Article No.	Article No.	Article No.	Article No.
<b>License</b> Extended Functions Basic positioner (EPoS) • CoL in electronic form	<b>6SL3054-4AG00-2AA0-Z E01</b>	<b>6SL3054-7TG00-2BA0-Z E01</b>	<b>6SL3054-7TH00-2BA0-Z E01</b>	<b>6SL3074-7AA04-0AH0</b>
<b>License</b> Extended Functions Safety (SLS, SSM, SDI) • CoL in electronic form	<b>6SL3054-4AG00-2AA0-Z F01</b>	<b>6SL3054-7TG00-2BA0-Z F01</b>	<b>6SL3054-7TH00-2BA0-Z F01</b>	<b>6SL3074-0AA10-0AH0</b>
<b>Licenses</b> Extended Functions Basic positioner (EPoS) + Safety (SLS, SSM, SDI) • CoL in electronic form	<b>6SL3054-4AG00-2AA0-Z E01+F01</b>	<b>6SL3054-7TG00-2BA0-Z E01+F01</b>	<b>6SL3054-7TH00-2BA0-Z E01+F01</b>	–

More information on firmware V4.7 SP13:

<https://support.industry.siemens.com/cs/document/109781149>

More information on firmware V4.7 SP14:

<https://support.industry.siemens.com/cs/document/109817231>

For an overview and more information on all available firmware versions, see

<https://support.industry.siemens.com/cs/document/67364620>

#### Selecting the Power Module

The optimum power unit can be quickly selected based on the required motor power, the supply voltage and the braking cycles to be expected. Power Modules in degree of protection IP20 are intended for installation in a control cabinet.

#### PM240-2 Power Modules – degree of protection IP20

PM240-2 Power Modules have an integrated braking chopper (four-quadrant applications) and are suitable for a large number of applications in general machinery construction.

#### PM250 Power Modules – degree of protection IP20

PM250 Power Modules are suitable for the same applications as the PM240-2. Any braking energy is directly fed back into the line supply (four-quadrant applications – a braking resistor is not required).

The Power Modules can be combined with the following Control Units:

Control Units	Power Modules degree of protection IP20	
	PM240-2	PM250
<b>CU230P-2</b>	✓	✓
<b>CU240E-2</b>	✓	✓
<b>CU250S-2</b>	✓	✓

<sup>1)</sup> The Certificate of License (CoL) is located on the SINAMICS SD card. In addition, notification of an optional download is received by email.

<sup>2)</sup> With a CoL in electronic form, the license is supplied as a PDF file. Notification of this with a download link is received by email.

## SINAMICS G120 standard converters

0.37 kW to 250 kW (0.5 hp to 400 hp)

### SINAMICS G120 standard converters

#### Design

##### PM240-2 and PM250 Power Modules

Rated power <sup>1)</sup>		Rated output current $I_N$ <sup>2)</sup>	Frame size	PM240-2 Power Modules Degree of protection IP20 All CUs pluggable Article No.	PM250 Power Module Degree of protection IP20 All CUs pluggable Article No.
kW	hp	A			
<b>200 ... 240 V 1 AC/3 AC</b>					
0.55	0.75	3.2	FSA	6SL3210-1PB13-0■L0	–
0.75	1	4.2	FSA	6SL3210-1PB13-8■L0	–
1.1	1.5	6	FSB	6SL3210-1PB15-5■L0	–
1.5	2	7.4	FSB	6SL3210-1PB17-4■L0	–
2.2	3	10.4	FSB	6SL3210-1PB21-0■L0	–
3	4	13.6	FSC	6SL3210-1PB21-4■L0	–
4	5	17.5	FSC	6SL3210-1PB21-8■L0	–
<b>200 ... 240 V 3 AC</b>					
5.5	7.5	22	FSC	6SL3210-1PC22-2■L0	–
7.5	10	28	FSC	6SL3210-1PC22-8■L0	–
11	15	42	FSD	6SL3210-1PC24-2UL0	–
15	20	54	FSD	6SL3210-1PC25-4UL0	–
18.5	25	68	FSD	6SL3210-1PC26-8UL0	–
22	30	80	FSE	6SL3210-1PC28-0UL0	–
30	40	104	FSE	6SL3210-1PC31-1UL0	–
37	50	130	FSF	6SL3210-1PC31-3UL0	–
45	60	154	FSF	6SL3210-1PC31-6UL0	–
55	75	178	FSF	6SL3210-1PC31-8UL0	–
<b>380 ... 480 V 3 AC</b>					
0.37 <sup>3)</sup>	0.5	1.3	–	– <sup>3)</sup>	–
0.55	0.75	1.7	FSA	6SL3210-1PE11-8■L1	–
0.75	1	2.2	FSA	6SL3210-1PE12-3■L1	–
1.1	1.5	3.1	FSA	6SL3210-1PE13-2■L1	–
1.5	2	4.1	FSA	6SL3210-1PE14-3■L1	–
2.2	3	5.9	FSA	6SL3210-1PE16-1■L1	–
3	4	7.7	FSA	6SL3210-1PE18-0■L1	–
4	5	10.2	FSB	6SL3210-1PE21-1■L0	–
5.5	7.5	13.2	FSB	6SL3210-1PE21-4■L0	–
<b>Heat sink variant</b>				↑	
<b>Standard</b>				0	
<b>Integrated line filter</b>				↑	
<b>Without</b>			(for IT systems)	U	
<b>Category C3 (only for FSG)</b>			(for IT systems <sup>4)</sup> )	C	
<b>Class A and Category C2 (for FSG)</b>			(for TN systems)	A	
<b>Class B</b>			(for TN systems)	–	Integrated line filter not available, as external option only

#### Data based on a duty cycle with low overload (LO).

Data based on duty cycle with high overload (HO), see section Power Modules.

<sup>1)</sup> Rated power based on the rated output current  $I_N$ . The rated output current  $I_N$  is based on the duty cycle for low overload (LO). Low overload (LO) generally applies for applications with low dynamic response (continuous operation), quadratic torque characteristic with low break loose torque and low speed accuracy. Examples: Centrifugal pumps, radial/axial fans, rotary piston fans, radial compressors, vacuum pumps, chain conveyors, agitators. High overload (HO) generally applies for applications with increased dynamic response (cyclic operation) and constant torque characteristics with high break loose torque. Examples: Gear pumps, eccentric worm pumps, mills, mixers, crushers, lifting/lowering gear, centrifuges.

<sup>2)</sup> The rated output current  $I_N$  is based on the duty cycle for low overload (LO). These current values are applicable for 200 V, 400 V or 690 V.

<sup>3)</sup> The PM240-2 Power Module with Article No. 6SL3210-1PE11-8. L1 corresponds to 0.37 kW (0.5 hp) with duty cycle HO.

<sup>4)</sup> The PM240-2 Power Modules frame size FSG with an integrated Category C3 filter can also be operated on TN systems with a grounded line conductor. To do so, the grounding screw must be removed. Then Category C3 can no longer be adhered to.

# SINAMICS G120 standard converters

0.37 kW to 250 kW (0.5 hp to 400 hp)

## SINAMICS G120 standard converters

### Design

Rated power <sup>1)</sup>		Rated output current $I_N^{2)}$	Frame size	PM240-2 Power Modules	PM250 Power Module
kW	hp			Degree of protection IP20	Degree of protection IP20
		A		All CUs pluggable	All CUs pluggable
				Article No.	Article No.
<b>380 ... 480 V 3 AC</b>					
7.5	10	18	FSB/FSC	6SL3210-1PE21-8 L0	6SL3225-0BE25-5AA1
11	15	26/25	FSC	6SL3210-1PE22-7 L0	6SL3225-0BE27-5AA1
15	20	32	FSC	6SL3210-1PE23-3 L0	6SL3225-0BE31-1AA1
18.5	25	38	FSD	6SL3210-1PE23-8 L0	6SL3225-0BE31-5 A0
22	30	45	FSD	6SL3210-1PE24-5 L0	6SL3225-0BE31-8 A0
30	40	60	FSD	6SL3210-1PE26-0 L0	6SL3225-0BE32-2 A0
37	50	75	FSD	6SL3210-1PE27-5 L0	6SL3225-0BE33-0 A0
45	60	90	FSE	6SL3210-1PE28-8 L0	6SL3225-0BE33-7 A0
55	75	110	FSE	6SL3210-1PE31-1 L0	6SL3225-0BE34-5 A0
75	100	145	FSF	6SL3210-1PE31-5 L0	6SL3225-0BE35-5 A0
90	125	178	FSF	6SL3210-1PE31-8 L0	6SL3225-0BE37-5 A0
110	150	205	FSF	6SL3210-1PE32-1 L0	–
132	200	250	FSF	6SL3210-1PE32-5 L0	–
160	250	302	FSG	6SL3210-1PE33-0 L0	–
200	300	370	FSG	6SL3210-1PE33-7 L0	–
250	400	477	FSG	6SL3210-1PE34-8 L0	–
<b>500 ... 690 V 3 AC</b>					
11	10	14	FSD	6SL3210-1PH21-4 L0	–
15	15	19	FSD	6SL3210-1PH22-0 L0	–
18.5	20	23	FSD	6SL3210-1PH22-3 L0	–
22	25	27	FSD	6SL3210-1PH22-7 L0	–
30	30	35	FSD	6SL3210-1PH23-5 L0	–
37	40	42	FSD	6SL3210-1PH24-2 L0	–
45	50	52	FSE	6SL3210-1PH25-2 L0	–
55	60	62	FSE	6SL3210-1PH26-2 L0	–
75	75	80	FSF	6SL3210-1PH28-0 L0	–
90	100	100	FSF	6SL3210-1PH31-0 L0	–
110	100	115	FSF	6SL3210-1PH31-2 L0	–
132	125	142	FSF	6SL3210-1PH31-4 L0	–
160	150	171	FSG	6SL3210-1PH31-7CL0	–
200	200	208	FSG	6SL3210-1PH32-1CL0	–
250	250	250	FSG	6SL3210-1PH32-5CL0	–
<b>Heat sink variant</b>				↑	
<b>Standard</b>				0	
<b>Integrated line filter</b>				↑	↑
<b>Without</b>			(for IT systems)	U	U
<b>Category C3 (only for FSG)</b>			(for IT systems <sup>4)</sup> )	C	–
<b>Class A and Category C2 (for FSG)</b>			(for TN systems)	A	A
<b>Class B</b>			(for TN systems)	–	Integrated line filter not available, as external option only

Data based on a duty cycle with low overload (LO).

Data based on duty cycle with high overload (HO), see section Power Modules.

## SINAMICS G120 standard converters

0.37 kW to 250 kW (0.5 hp to 400 hp)

### SINAMICS G120 standard converters

#### Design

##### **Selecting optional system components**

###### IOP-2 Intelligent Operator Panel

Color display, new functions, functional design for faster commissioning and easy adjustment of settings during operation. The most striking features are the new flat design of the operator panel and its integrated membrane keyboard with a central sensor control field.

###### IOP-2 Handheld Intelligent Operator Panel

A handheld version of the IOP-2 can be ordered for mobile use. In addition to the IOP-2, this includes a housing with rechargeable batteries, charging unit and RS232 connecting cable.

###### BOP-2 Basic Operator Panel

Menu navigation and 2-line display permit fast and user-friendly commissioning of the converter. Simple basic commissioning by simultaneously displaying parameter and parameter value, as well as the option of filtering parameters.

###### Door mounting kit for IOP-2/BOP-2

Using the optionally available door mounting kit, the IOP-2/BOP-2 can be mounted in a control cabinet door with just a few manual operations (IP55/UL Type 12 degree of protection is achieved).

###### Memory card

The parameter settings for a converter can be stored on the SINAMICS SD memory card. When service is required, e.g. after the converter has been replaced, the drive system is immediately ready for use again. The memory card can also be used to upgrade the firmware of the Control Unit.

###### SINAMICS G120 Smart Access

Wireless commissioning, operation and diagnostics via mobile device or laptop thanks to the optional web server module SINAMICS G120 Smart Access enabling user-friendly operation and easy access to the converter, even if this is installed in areas difficult to access.

###### Brake Relay

The Brake Relay allows the Power Module to be connected to an electromechanical motor brake. This allows the motor brake to be controlled directly from the Control Unit.

###### Safe Brake Relay

The Safe Brake Relay allows the Power Module to be safely connected to an electromechanical motor brake, allowing the brake to be directly and safely controlled from the CU250S-2 Control Unit in accordance with IEC 61508 SIL 2 and EN ISO 13849-1 PL d and Category 3.

###### PC converter connection kit 2

For controlling and commissioning a converter directly from a PC if the appropriate software (STARTER commissioning tool or SINAMICS Startdrive) has been installed.

###### Shield connection kits for Power Modules

The shield connection kit makes it easier to connect the shields of supply and control cables, provides mechanical strain relief and thus ensures optimum EMC performance.

A shield connection kit is supplied as standard with PM240-2 Power Modules in frame sizes FSA to FSC.

A set of shield plates is included in the scope of delivery for the motor and signal cables corresponding to the frame size for the frame sizes FSD to FSG. For the electromagnetically compatible connection of an optionally connectable braking resistor, the corresponding shield connection kit is to be ordered for frame sizes FSD to FSG.

###### Shield connection kits for Control Units

The shield connection kit offers optimum shield connection and strain relief for all signal and communication cables. It includes a matching shield connection plate and all of the necessary connecting and retaining elements for mounting.

###### Wiring adapter for frame size FSG

The wiring adapter enables optimal and space-saving wiring of frame size FSG for SINAMICS G120 Power Modules PM240-2. It contains all of the necessary retaining elements for mounting.

## SINAMICS G120 standard converters

0.37 kW to 250 kW (0.5 hp to 400 hp)

### SINAMICS G120 standard converters

#### Design

Description	Article No.
<b>IOP-2 Intelligent Operator Panel</b> Operating languages: English, German, French, Italian, Spanish, Portuguese, Dutch, Swedish, Finnish, Russian, Czech, Polish, Turkish, Chinese Simplified	<b>6SL3255-0AA00-4JA2</b>
<b>IOP-2 Handheld Operator Panel</b>	<b>6SL3255-0AA00-4HA1</b>
<b>BOP-2 Operator Panel</b>	<b>6SL3255-0AA00-4CA1</b>
<b>Door mounting kit</b> for IOP-2/BOP-2	<b>6SL3256-0AP00-0JA0</b>
<b>SINAMICS SD card <sup>1)</sup></b> 512 MB Memory Card	<b>6SL3054-4AG00-2AA0</b>
<b>Brake Relay</b>	<b>6SL3252-0BB00-0AA0</b>
<b>Safe Brake Relay</b>	<b>6SL3252-0BB01-0AA0</b>
<b>PC converter connection kit 2</b>	<b>6SL3255-0AA00-2CA0</b>

Description	Article No.
<b>Shield connection kits</b>	
<ul style="list-style-type: none"> <li>For PM240-2 Power Modules <ul style="list-style-type: none"> <li>Frame sizes FSA to FSC</li> </ul> </li> <li>Frame sizes FSD to FSG A set of shield plates is included in the scope of delivery for the motor and signal cables corresponding to the frame size. For the electromagnetically compatible connection of an optionally connectable braking resistor, the corresponding shield connection kit is to be ordered.</li> </ul>	Supplied with the Power Modules, available as a spare part
- Frame size FSD	<b>6SL3262-1AD01-0DA0</b>
- Frame size FSE	<b>6SL3262-1AE01-0DA0</b>
- Frame size FSF	<b>6SL3262-1AF01-0DA0</b>
- Frame size FSG	<b>6SL3262-1AG01-0DA0</b>
- For PM250 Power Modules	
- Frame size FSC	<b>6SL3262-1AC00-0DA0</b>
- Frame sizes FSD and FSE	<b>6SL3262-1AD00-0DA0</b>
- Frame size FSF	<b>6SL3262-1AF00-0DA0</b>
• For Control Units	
- For CU230P-2 HVAC and CU230P-2 DP	<b>6SL3264-1EA00-0FA0</b>
- For CU240E-2	<b>6SL3264-1EA00-0HA0</b>
- For CU230P-2 PN, CU240E-2 PN and CU240E-2 PN-F	<b>6SL3264-1EA00-0HB0</b>
- For CU250S-2	<b>6SL3264-1EA00-0LA0</b>
<b>Wiring adapter for frame size FSG</b>	<b>6SL3266-2HG00-0BA0</b>
<b>STARTER commissioning tool <sup>2)</sup></b> on DVD-ROM	<b>6SL3072-0AA00-0AG0</b>
<b>SINAMICS Startdrive commissioning tool <sup>3)</sup></b> on DVD-ROM	<b>6SL3072-4EA02-0XG0</b>

<sup>1)</sup> Approved for CU230P-2 HVAC and CU230P-2 DP Control Units with firmware version V4.6 and higher.

<sup>2)</sup> STARTER commissioning tool is also available on the internet at [www.siemens.com/starter](http://www.siemens.com/starter)

<sup>3)</sup> The SINAMICS Startdrive commissioning tool is also available on the internet at <https://support.industry.siemens.com/cs/document/68034568>

## SINAMICS G120 standard converters

0.37 kW to 250 kW (0.5 hp to 400 hp)

### SINAMICS G120 standard converters

#### Design

##### Line-side components

The following line-side components are available for SINAMICS G120 standard converters:

##### Line filter

With one of the additional line filters, the Power Module attains a higher radio interference class.

##### Line Harmonics Filters

(only for PM240-2 Power Modules, frame sizes FSD to FSG)

Using a Line Harmonics Filter makes for a substantial reduction in unwanted harmonics. In this way, a THD(I) value less than 5 % can be achieved and observance of the limit values according to IEC 61000-3-12, IEC 61000-2-2 and IEEE 519 is possible independently of the line impedance.

##### Line reactors

(for PM240-2 Power Modules only)

Line reactors smooth the current drawn by the converter and thus reduce harmonic components in the line current. Through the reduction of the current harmonics, the thermal load on the power components in the rectifier and in the DC link capacitors is reduced as well as the harmonic effects on the supply. The use of a line reactor increases the service life of the converter.

A DC link reactor is integrated in the PM240-2 Power Modules, frame sizes FSD to FSG, and therefore no line reactor is required. No line reactor is provided for the PM250 Power Modules, nor may one be used.

##### Recommended line-side overcurrent protection devices

Overcurrent protection devices are absolutely necessary for the operation of the converters. The tables listed in the section "Recommended line-side overcurrent protection devices" provide recommendations according to IEC and UL regulations, depending on the area of application. Recommendations on further overcurrent protection devices are available at: <https://support.industry.siemens.com/cs/document/109486009>

Additional information about the listed Siemens fuses is available in Catalog LV 10 as well as in the Industry Mall.

##### DC link components

The following DC link components are available for the SINAMICS G120 standard converters:

##### Braking resistors

(for PM240-2 Power Modules only)

Excess energy in the DC link is dissipated in the braking resistor. The braking resistors are designed for use with PM240-2 Power Modules. They are equipped with an integrated braking chopper (electronic switch).

For the electromagnetically compatible connection of an optionally connectable braking resistor, the corresponding shield connection kit is to be ordered for frame sizes FSD to FSG.

##### Load-side power components

The following load-side power components are available for the SINAMICS G120 standard converters. This means that during operation with output reactors or sine-wave filters, longer, shielded motor cables are possible and the motor service life can be extended:

##### Output reactors

Output reactors reduce the rate of voltage rise (dv/dt) and the height of the current peaks, and can allow longer motor cables to be connected.

##### Sine-wave filters

Sine-wave filters limit the rate of voltage rise (dv/dt) and the peak voltages on the motor winding. Similar to an output reactor, they enable the connection of longer motor cables.

##### dv/dt filters plus VPL

(PM240-2 Power Modules 400-V and 690-V versions only)

dv/dt filters plus voltage peak limiters limit the rate of voltage rise and the typical voltage peaks.

##### Additional options

Further selected accessories are available from "Siemens Product Partner for Drives Options": [www.siemens.com/drives-options-partner](http://www.siemens.com/drives-options-partner)

##### Spare parts

##### Spare parts kit for Control Units

The spare parts kit contains small parts for all variants of the following SINAMICS G120 Control Units:

- CU230P-2
- CU240E-2
- CU240E-2 F
- CU250S-2

##### Shield connection kits for PM240-2 Power Modules

A shield connection kit is supplied as standard with PM240-2 Power Modules in frame sizes FSA to FSC. This shield connection kit is also available as a spare part.

A set of shield plates is included in the scope of delivery for the motor and signal cables corresponding to the frame size for the frame sizes FSD to FSG. For the electromagnetically compatible connection of an optionally connectable braking resistor, the corresponding shield connection kit is to be ordered for frame sizes FSD to FSG.

##### Terminal cover kits for frame sizes FSD to FSG

The terminal cover kit includes a replacement cover for the connecting terminals. Terminal cover kits which are suitable for the PM240-2 and PM250 Power Modules are available.

##### Replacement connectors for PM240-2 Power Modules

A set of connectors for the line feeder cable, braking resistor and motor cable can be ordered corresponding to the frame size of the PM240-2 Power Module.

##### Fan units for PM240-2 Power Modules

The fans of PM240-2 Power Modules are designed for extra long service life. For special requirements, replacement fans are available that can be exchanged quickly and easily.

##### Replacement fans for PM250 Power Modules

The fans of PM250 Power Modules are designed for extra long service life. Replacement fans can be ordered for special applications.

## Configuration

The following electronic configuring aids and engineering tools are available for the SINAMICS G120 standard converters:

### **SINAMICS DriveSim Basic (firmware V4.7 SP13 or higher)**

SINAMICS DriveSim Basic provides easy-to-use models for PRO-Fl drive-enabled SINAMICS converters, so you can create a digital twin of your drive.

More information is provided on the internet at:  
<https://support.industry.siemens.com/cs/document/109798225>

### **Siemens Product Configurator**

The Siemens Product Configurator helps you to configure the optimum drive technology products for a number of applications – starting with gearboxes, motors, converters as well as the associated options and components and ending with controllers, software licenses and connection systems.

The Siemens Product Configurator can be used on the internet without requiring any installation. The Siemens Product Configurator can be found in the Siemens Industry Mall at the following address:  
[www.siemens.com/spc](http://www.siemens.com/spc)

### **SIMARIS planning tools for plants with SINAMICS drives**

Electrical planning: Even easier with software!

Electrical planning for power distribution in non-residential and industrial buildings has never been more complex. To ensure you, as a specialist planner, have the best hand when it comes to electrical planning with SINAMICS drives, we provide support with the following efficient software tools: SIMARIS design for dimensioning and SIMARIS project for calculating the space requirements of the distribution boards.

You can find more information on the SIMARIS planning tools for plants with SINAMICS drives in the [Engineering tools section](#).

### **SIZER for Siemens Drives (integrated in the TIA Selection Tool) engineering tool**

The SIZER for Siemens Drives engineering tool makes it easy to configure the SINAMICS converter family. It provides support when selecting the hardware and firmware components necessary to implement a drive task. SIZER for Siemens Drives is designed to support configuring of the entire drive system.

You can find more information on the SIZER for Siemens Drives engineering tool in the [Engineering tools section](#).

The SIZER for Siemens Drives engineering tool is available free on the internet at:  
[www.siemens.com/sizer](http://www.siemens.com/sizer)

### **STARTER commissioning tool**

The STARTER commissioning tool allows menu-prompted commissioning, optimization and diagnostics and the TIA functionality. Apart from the SINAMICS drives, STARTER is also suitable for MICROMASTER 4 devices.

You can find more information on the STARTER commissioning tool in the [Engineering tools section](#).

More information about the STARTER commissioning tool is available on the internet at  
[www.siemens.com/starter](http://www.siemens.com/starter)

### **SINAMICS Startdrive commissioning tool**

SINAMICS Startdrive is a tool for configuring, commissioning, and diagnosing the SINAMICS family of converters and is integrated into the TIA Portal. SINAMICS Startdrive can be used to implement drive tasks with the SINAMICS G110M, SINAMICS G120, SINAMICS G120C, and SINAMICS G120D converter series. The commissioning tool has been optimized with regard to user friendliness and consistent use of the TIA Portal benefits of a common working environment for PLC, HMI and drives.

You can find more information on the SINAMICS Startdrive commissioning tool in the [Engineering tools section](#).

The SINAMICS Startdrive commissioning tool is available for free on the internet at:  
[www.siemens.com/startdrive](http://www.siemens.com/startdrive)

### **Drive ES engineering system**

Drive ES is the engineering system that can be used to integrate the communication, configuration and data management functions of Siemens drive technology into the SIMATIC automation world easily, efficiently and cost-effectively. The Drive ES PCS software package is available for SINAMICS.

You can find more information on the Drive ES engineering system in the [Engineering tools section](#).

More information about the Drive ES engineering system is available on the internet at  
[www.siemens.com/drive-es](http://www.siemens.com/drive-es)

## SINAMICS G120 standard converters

0.37 kW to 250 kW (0.5 hp to 400 hp)

### SINAMICS G120 standard converters

#### Technical specifications

Unless explicitly specified otherwise, the following technical specifications are valid for all the following components of the SINAMICS G120 standard converters.

General technical specifications	
Mechanical ambient conditions	
<b>Long-term storage</b> according to EN 60721-3-1: 1997 <ul style="list-style-type: none"> <li>Devices and components, frame sizes FSA ... FSG <sup>1)</sup></li> </ul>	Class 1M2
<b>Transport</b> according to EN 60721-3-2: 1997 <ul style="list-style-type: none"> <li>Devices and components, frame sizes FSA ... FSG <sup>2)</sup></li> </ul>	Class 2M3
<b>Operation</b> according to EN 60721-3-3: 2002 <ul style="list-style-type: none"> <li>Devices and components, frame sizes FSA ... FSG</li> <li>- Vibration test</li> <li>- Shock test</li> </ul>	Class 3M1  Test Fc (sinusoidal) according to EN 60068-2-6 Deflection: 0.075 mm (0.003 in) at 10 ... 57 Hz Acceleration: 10 m/s <sup>2</sup> (32.8 ft/s <sup>2</sup> ) (1 × g) at 57 ... 150 Hz 10 frequency cycles per axis  Test Ea (semi-sinusoidal) according to EN 60068-2-27 Acceleration: 49 m/s <sup>2</sup> (161 ft/s <sup>2</sup> ) (5 × g) at 30 ms 3 shocks in all three axes in both directions

General technical specifications	
Ambient conditions	
<b>External 24 V supply</b> according to IEC 60204-1	Contact-safe SELV or PELV power supply. The supply voltage must not exceed 60 V DC under single fault conditions.
<b>Protection class</b> according to EN 61800-5-1	Class I (with protective grounding conductor)
<b>Permissible ambient and coolant temperature (air) during operation for line-side components and Power Modules</b>  <ul style="list-style-type: none"> <li>Low overload (LO)               <ul style="list-style-type: none"> <li>- PM240-2, frame sizes FSA ... FSC -10 ... +40 °C (14 ... 104 °F) without derating &gt;40 ... 60 °C (&gt;104 ... 140 °F) <a href="#">see derating characteristics</a></li> <li>- PM240-2, frame sizes FSD ... FSG -20 ... +40 °C (-4 ... +104 °F) without derating &gt;40 ... 60 °C (&gt;104 ... 140 °F) <a href="#">see derating characteristics</a></li> <li>- PM250 0 ... 40 °C (32 ... 104 °F) without derating &gt;40 ... 60 °C (&gt;104 ... 140 °F) <a href="#">see derating characteristics</a></li> </ul> </li> <li>High overload (HO)               <ul style="list-style-type: none"> <li>- PM240-2, frame sizes FSA ... FSC -10 ... +50 °C (14 ... 122 °F) without derating &gt;50 ... 60 °C (&gt;104 ... 140 °F) <a href="#">see derating characteristics</a></li> <li>- PM240-2, frame sizes FSD ... FSG -20 ... +50 °C (-4 ... +122 °F) without derating &gt;50 ... 60 °C (&gt;104 ... 140 °F) <a href="#">see derating characteristics</a></li> <li>- PM250 0 ... 50 °C (32 ... 122 °F) without derating &gt;50 ... 60 °C (&gt;122 ... 140 °F) <a href="#">see derating characteristics</a></li> </ul> </li> </ul>	
<b>Permissible ambient and coolant temperature (air) during operation for Control Units and supplementary system components</b>	With CU230P-2 HVAC and CU230P-2 DP: -10 ... +60 °C (14 ... 140 °F) With CU230P-2 PN: -10 ... +55 °C (14 ... 131 °F) With CU240E-2 (without PN): -10 ... +55 °C (14 ... 131 °F) With CU240E-2 PN and CU240E-2 PN-F: -10 ... +53 °C (14 ... 127.4 °F) With CU250S-2: -10 ... +50 °C (14 ... 122 °F) With IOP/BOP-2: 0 ... 50 °C (32 ... 122 °F)  Derating of 3 K/1000 m (3281 ft) applies to Control Units as of an installation altitude of 1000 m (3281 ft) above sea level.

<sup>1)</sup> In product packaging.

<sup>2)</sup> In transport packaging.



# SINAMICS G120 standard converters

## 0.37 kW to 250 kW (0.5 hp to 400 hp)

### SINAMICS G120 standard converters

#### Technical specifications

General technical specifications	
<b>Ambient conditions</b> (continued)	
<b>Climatic ambient conditions</b>	
<ul style="list-style-type: none"> <li>Storage <sup>1)</sup> acc. to EN 60721-3-1: 1997</li> <li>Transport <sup>1)</sup> acc. to EN 60721-3-2: 1997</li> <li>Operation acc. to EN 60721-3-3: 2002</li> </ul>	Class 1K4 Temperature: -25 ... +55 °C (-13 ... +131 °F)  Class 2K4 Temperature -40 ... +70 °C (-40 ... +158 °F)  <u>Better than class 3K3 with regard to</u> <ul style="list-style-type: none"> <li>Temperature: -10 ... +40 °C (14 ... 104 °F) without derating &gt;40 ... 60 °C (&gt;32 ... 140 °F) <a href="#">see derating characteristics</a></li> <li>Relative humidity: 5 ... 95 % (no condensation) Oil mist, ice formation, condensation, dripping water, spraying water, splashing water and water jets are not permitted</li> </ul>
<b>Environmental class/harmful chemical substances</b>	
<ul style="list-style-type: none"> <li>Storage <sup>1)</sup> acc. to EN 60721-3-1: 1997</li> <li>Transport <sup>1)</sup> acc. to EN 60721-3-2: 1997</li> <li>Operation acc. to EN 60721-3-3: 2002</li> </ul>	Class 1C2  Class 2C2  Class 3C2 <sup>2)</sup>
<b>Organic/biological influences</b>	
<ul style="list-style-type: none"> <li>Storage <sup>1)</sup> acc. to EN 60721-3-1: 1997</li> <li>Transport <sup>1)</sup> acc. to EN 60721-3-2: 1997</li> <li>Operation acc. to EN 60721-3-3: 2002</li> </ul>	Class 1B1  Class 2B1  Class 3B1
<b>Degree of pollution</b> acc. to EN 61800-5-1	2
<b>Certification for fail-safe versions</b>	
Applies to Control Units of the CU240E-2 and CU250S-2 series. The values include Control Unit and Power Module.  Note: The Safety Integrated Function Manual contains detailed information about the Safety Integrated Functions: <a href="https://support.industry.siemens.com/cs/document/109782490">https://support.industry.siemens.com/cs/document/109782490</a>	The PM240-2 Power Modules, frame sizes FSD to FSG additionally offer STO acc. to IEC 61508 SIL 3 and EN ISO 13489-1 PL e and Category 3.
<ul style="list-style-type: none"> <li>According to IEC 61508</li> <li>According to EN ISO 13849-1</li> </ul>	SIL 2  PL d and Category 3
<b>Standards</b>	
<b>Compliance with standards</b>	
- PM240-2	CE, UKCA, cULus, RCM, SEMI F47, RoHS, EAC, KC (only with internal or external line filters of Category C2) For frame sizes FSD ... FSG also: WEEE (Waste Electrical & Electronic Equipment)
- PM250	CE, UKCA, UL, cUL, RCM, SEMI F47
<b>CE marking, according to</b>	
Low-Voltage Directive 2014/35/EU Ecodesign requirements of the EU Directive 2019/1781 <sup>3)</sup>	

General technical specifications	
<b>EMC Directive acc. to EN 61800-3</b>	
<b>Interference immunity</b>	
<b>PM240-2 Power Modules</b> <b>PM250 Power Modules</b>	The Power Modules are tested according to the interference immunity requirements for environments according to Category C3
<b>Interference emissions</b>	
<b>PM240-2 Power Modules</b>	<ul style="list-style-type: none"> <li>Frame sizes FSA to FSF without integrated line filter</li> <li>Frame sizes FSA to FSC with integrated line filter class A</li> <li>Frame sizes FSD to FSG with integrated line filter class A</li> <li>Frame sizes FSA to FSC without integrated line filter with optional line filter class B</li> </ul>
<b>PM250 Power Modules</b>	<ul style="list-style-type: none"> <li>Frame size FSC with integrated line filter class A</li> <li>Frame size FSC with integrated line filter class A and optional line filter class B</li> <li>Frame sizes FSD to FSF without integrated line filter</li> <li>Frame sizes FSD to FSF with integrated line filter class A</li> </ul>

#### Note:

The EMC product standard EN 61800-3 does not apply directly to a frequency converter but to a PDS (Power Drive System), which comprises the complete circuitry, motor and cables in addition to the converter. The frequency converters on their own do not generally require identification according to the EMC Directive.

- <sup>1)</sup> In transport packaging.
- <sup>2)</sup> SIPLUS components for extreme requirements are available. More information is available on the internet at [www.siemens.com/siplus-drives](http://www.siemens.com/siplus-drives)
- <sup>3)</sup> The SINAMICS G120 frequency converters fall under the ecodesign requirements of the EU Directive 2019/1781; however, the SINAMICS G120 frequency converters with PM250 Power Modules are considered to be frequency converters with regenerative feedback functionality. Therefore, no efficiency requirements apply in this case.
- <sup>4)</sup> Unfiltered devices are designed for operation on IT systems or in conjunction with an RCD. The customer must provide suitable RI suppression equipment to ensure that these devices comply with the limits defined for Category C3 or C2.
- <sup>5)</sup> Max. permissible cable lengths [see section Power Modules → Integration](#).

## SINAMICS G120 standard converters

0.37 kW to 250 kW (0.5 hp to 400 hp)

### SINAMICS G120 standard converters

#### Technical specifications

##### Compliance with standards

##### CE marking



The SINAMICS G120 converters meet the requirements of the Low-Voltage Directive 2014/35/EU.

##### Low-Voltage Directive

The converters comply with the following standards listed in the official journal of the EU:

- EN 60204  
Safety of machinery, electrical equipment of machines
- EN 61800-5-1  
Adjustable Speed Electrical Power Drive Systems – Part 5-1: Requirements regarding safety – electrical, thermal, and energy requirements

##### UL listing



Converter devices in UL category NMMS certified to UL and cUL, in compliance with UL508C. UL list numbers E121068 and E192450. This applies to all PM240-2 and PM250 Power Modules.

For use in environments with pollution degree 2.

See also on the internet at [www.ul.com](http://www.ul.com)

##### Machinery Directive

The converters are suitable for installation in machines. Compliance with the Machinery Directive 2006/42/EC requires a separate certificate of conformity. This must be provided by the plant construction company or the organization marketing the machine.

##### EMC Directive

- EN 61800-3  
Adjustable Speed Electrical Power Drive Systems  
Part 3: EMC product standard including specific test methods

The following information applies to SINAMICS G120 frequency converters from Siemens:

- The EMC product standard EN 61800-3 does not apply directly to a frequency converter but to a PDS (Power Drive System), which comprises the complete circuitry, motor and cables in addition to the converter.
- Frequency converters are normally only supplied to experts for installation in machines or systems. A frequency converter must, therefore, only be considered as a component which, on its own, is not subject to the EMC product standard EN 61800-3. The converter's operating instructions, however, specify the conditions regarding compliance with the product standard if the frequency converter is expanded to become a PDS. For a PDS, the EMC Directive in the EU is complied with by observing the product standard EN 61800-3 for variable-speed electric drive systems. The frequency converters on their own do not generally require identification according to the EMC Directive.

- Different categories C1 to C4 have been defined in accordance with the environment of the PDS at the operating location:
  - **Category C1:** Drive systems for rated voltages < 1000 V for use in the first environment
  - **Category C2:** Stationary drive systems not connected by means of a plug connector for rated voltages < 1000 V. When used in the first environment, the system must be installed and commissioned by personnel familiar with EMC requirements. A warning note is required.
  - **Category C3:** Drive systems for rated voltages < 1000 V for exclusive use in the second environment. A warning note is required.
  - **Category C4:** Drive systems for rated voltages ≥ 1000 V or for rated currents ≥ 400 A or for use in complex systems in the second environment. An EMC plan must be created.
- The EMC product standard EN 61800-3 also defines limit values for conducted interference and radiated interference for the "second environment" (= industrial power supply systems that do not supply households). These limit values are below the limit values of filter class A acc. to EN 55011. Unfiltered converters can be used in industrial environments as long as they are part of a system that contains line filters on the higher-level infeed side.
- With SINAMICS G120, Power Drive Systems (PDS) that fulfill the EMC product standard EN 61800-3 can be configured when observing the installation instructions in the product documentation.
- A differentiation must be made between the product standards for electrical drive systems (PDS) of the range of standards EN 61800 (of which Part 3 covers EMC topics) and the product standards for the devices/systems/machines, etc. This will probably not result in any changes in the practical use of frequency converters. Since frequency converters are always part of a PDS and these are part of a machine, the machine manufacturer must observe various standards depending on their type and environment (e.g. EN 61000-3-2 for line harmonics and EN 55011 for radio interference). The product standard for PDS on its own is, therefore, either insufficient or irrelevant.
- With respect to the compliance with limits for line supply harmonics, the EMC product standard EN 61800-3 for PDS refers to compliance with the EN 61000-3-2 and EN 61000-3-12 standards.
- Regardless of the configuration with SINAMICS G120 and its components, the machine construction company (OEM) can also apply other measures to ensure that the machine complies with the EU EMC Directive. The EU EMC Directive is generally fulfilled when the relevant EMC product standards are observed. If they are not available, the generic standards (e.g. DIN EN 61000-x-x) can be used instead. It is important that the conducted and emitted interference at the line supply connection point and outside the machine remain below the relevant limit values. Any suitable technical measures can be applied to ensure this.

##### SEMI F47

SEMI F47 is an industry standard relating to the immunity to voltage dips. This includes the requirement that industrial equipment must be able to tolerate defined dips or drops of the line supply voltage. As a result, industrial equipment that fulfills this standard is more reliable and productive. In the SINAMICS G120 product family, the PM240-2 and PM250 Power Modules fulfill the latest SEMI F47-0706 standard. In the case of a voltage dip, defined in accordance with SEMI F47-0607, these drives either continue to supply a defined output current, or using an automatic restart function, continue to operate as expected.

## Overview

### CU230P-2 Control Units



CU230P-2 PN Control Unit

The Control Unit performs closed-loop control functions for the converter.

The CU230P-2 Control Units are designed for drives with integrated technological functions for pump, fan and compressor applications.

The I/O interface, the fieldbus interfaces and the additional software functions optimally support these applications. The integration of technological functions is a significant differentiating feature to the other Control Units of the SINAMICS G120 converter family.

The CU230P-2 Control Units can be operated with the following Power Modules:

- PM240-2
- PM250

#### Note:

Shield plates and shield connection kits are available for use in the wiring installation of Control Units and Power Modules to ensure that it complies with EMC guidelines.

[For more information about shield connection kits and shield plates for Control Units and Power Modules, please refer to section Supplementary system components.](#)

#### Typical, integrated HVAC/HLK functions

- Linear and quadratic torque characteristic for fluid flow and positive displacement machines
- ECO mode for additional energy saving in V/f control mode
- 2 analog inputs (current/voltage can be selected) to directly connect pressure/level sensors
- 2 additional analog inputs to connect Pt1000/LG-Ni1000/DIN-Ni1000 temperature sensors
- Direct control of valves and flaps using two 230 V AC relays
- Automatic restart
- Flying restart
- Skip frequencies
- Hibernation mode
- Load check function to monitor belts and flow
- Cascade connection
- 4 integrated PID controllers (e.g. for temperature, pressure, air quality, level)
- Multi-zone controller
- Essential service mode
- Real time clock with three time generators

#### IOP-2 wizards for special applications

- Pumps: Positive displacement (constant load torque) and centrifugal pumps (square load torque) with and without PID controller
- Fans: Radial and axial fans (square load torque) with and without PID controller
- Compressors: Positive displacement (constant load torque) and fluid flow machines (square load torque) with and without PID controller

## SINAMICS G120 standard converters

0.37 kW to 250 kW (0.5 hp to 400 hp)

### Control Units

#### Overview

##### CU240E-2 Control Units



CU240E-2 DP-F Control Unit

The Control Unit performs closed-loop control functions for the converter.

The CU240E-2 Control Units are designed as standard Control Units for all of the usual applications involving V/f or vector control.

- CU240E-2 series with standard I/O quantity structure and integrated safety technology

The CU240E-2 Control Unit can be combined with the following Power Modules:

- PM240-2
- PM250

##### Note:

Shield plates and shield connection kits are available for use in the wiring installation of Control Units and Power Modules to ensure that it complies with EMC guidelines.

For more information about shield connection kits and shield plates for Control Units and Power Modules, please refer to section Supplementary system components.

##### Safety Integrated Functions

The Safety Integrated Function "Safe Torque Off" (STO) (certified according to IEC 61508 SIL 2 and EN ISO 13849-1 PL d and Category 3) is already integrated into the basic versions of the CU240E-2 series (CU240E-2, CU240E-2 DP, CU240E-2 PN).

With the fail-safe variants of the CU240E-2 series (CU240E-2 F, CU240E-2 DP-F, CU240E-2 PN-F), the fail-safe SINAMICS G120 converter provides five safety functions which are certified according to IEC 61508 SIL 2 and EN ISO 13849-1 PL d and Category 3:

- Safe Torque Off (STO)  
to protect against active movement of the drive
- Safe Stop 1 (SS1)  
for continuous monitoring of a safe braking ramp
- Safely-Limited Speed (SLS)  
for protection against dangerous movements when a speed limit is exceeded (the CU240E-2 DP Failsafe Control Unit has 4 selectable SLS limit values)
- Safe Direction (SDI)  
This function ensures that the drive can only rotate in the selected direction.
- Safe Speed Monitor (SSM)  
This function signals if a drive operates below a specific speed/feed velocity (CU240E-2 DP-F / CU240E-2 PN-F with PROFIsafe).

These functions can be activated by means of PROFIsafe or via the safety inputs.

None of the safety functions require a motor encoder and they are thus much cheaper and easier to implement. Existing systems in particular can be simply updated with safety technology without the need to change the motor or mechanical system.

The Safe Torque Off (STO) function can be used without restriction for all applications. The SS1, SLS, SDI and SSM functions are only permissible for applications where the load can never accelerate when the converter is switched off. They are therefore not permitted for applications involving pull-through loads such as hoisting gear and unwinders.

Further information can be found in the section [Safety Integrated](#).

## Overview

### CU250S-2 Control Units



CU250S-2 Control Unit

The Control Unit performs closed-loop control functions for the converter.

The CU250S-2 Control Units are designed as standard Control Units for all of the usual applications involving V/f or vector control.

CU250S-2 Control Units can be used to implement all common applications involving V/f or vector control as well as applications for drives with positioning requirements. This expansion allows them to be used in lifting, swiveling, traversing or rotating applications. The positioning functionality is comparable with SINAMICS S110 servo drives.

Two points must be noted here:

- Vector control (VC) and sensorless vector control (SLVC) are possible
- Encoder possible for speed and position control (positioning)

The CU250S-2 Control Units can be combined with the following Power Modules:

- PM240-2
- PM250

#### Note:

Shield plates and shield connection kits are available for use in the wiring installation of Control Units and Power Modules to ensure that it complies with EMC guidelines.

For more information about shield connection kits and shield plates for Control Units and Power Modules, please refer to section Supplementary system components.

### Safety Integrated Functions

The following Safety Integrated Basic Functions (certified according to IEC 61508 SIL 2 and EN ISO 13849-1 PL d and Category 3) are integrated as standard in the CU250S-2 series:

- Safe Torque Off (STO)  
to protect against active movement of the drive
- Safe Stop 1 (SS1)  
for continuous monitoring of a safe braking ramp
- Safe Brake Control (SBC) is used to safely control a holding brake

The following Safety Integrated Extended Functions (certified according to IEC 61508 SIL 2 and EN ISO 13849-1 PL d and Category 3) are optionally available for the CU250S-2 series:

- Safely-Limited Speed (SLS)  
for protection against dangerous movements when a speed limit is exceeded
- Safe Direction (SDI)  
This function ensures that the drive can only rotate in the selected direction.
- Safe Speed Monitor (SSM)  
This function signals if a drive operates below a specific speed/feed velocity.

These functions can be activated by means of PROFIsafe or via the safety inputs.

None of the safety functions require a motor encoder and they are thus much cheaper and easier to implement. Existing systems in particular can be simply updated with safety technology without the need to change the motor or mechanical system.

The Safe Torque Off (STO) function can be used without restriction for all applications. The SS1, SLS, SDI and SSM functions are only permissible for applications where the load can never accelerate when the converter is switched off. They are therefore not permitted for applications involving pull-through loads such as hoisting gear and unwinders.

Further information can be found in the section [Safety Integrated](#).

## SINAMICS G120 standard converters

0.37 kW to 250 kW (0.5 hp to 400 hp)

### Control Units

#### Design

#### CU230P-2 HVAC, CU230P-2 DP and CU230P-2 PN Control Units

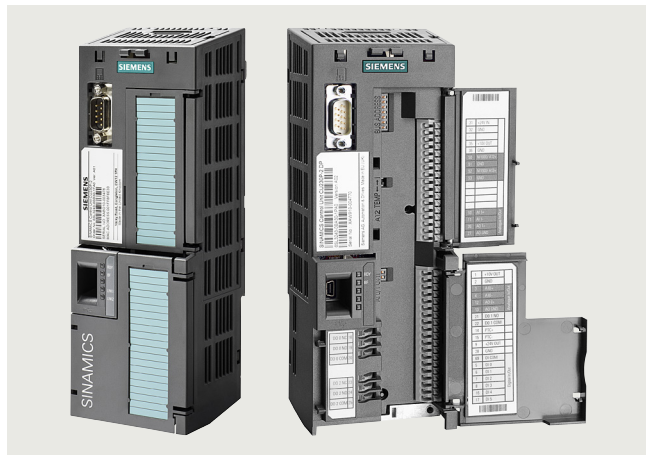

CU230P-2 Control Unit with open and closed terminal covers

Terminal No.	Signal	Features
<b>Digital inputs (DI) – Standard</b>		
69	DI COM	Reference potential for digital inputs
5 ... 8, 16, 17	DI0 ... DI5	Freely programmable isolated, inputs in compliance with IEC 61131-2
<b>Digital outputs (DO)</b>		
18	DO0, NC	Relay output 1 NC contact (5 A, 30 V DC or 2 A, 250 V AC) <sup>1)</sup>
19	DO0, NO	Relay output 1 NO contact (5 A, 30 V DC or 2 A, 250 V AC)
20	DO0, COM	Relay output 1 Common contact (5 A, 30 V DC or 2 A, 250 V AC) <sup>1)</sup>
21	DO1, NO	Relay output 2 NO contact (0.5 A, 30 V DC)
22	DO1, COM	Relay output 2 Common contact (0.5 A, 30 V DC)
23	DO2, NC	Relay output 3 NC contact (5 A, 30 V DC or 2 A, 250 V AC) <sup>1)</sup>
24	DO2, NO	Relay output 3 NO contact (5 A, 30 V DC or 2 A, 250 V AC)
25	DO2, COM	Relay output 3 Common contact (5 A, 30 V DC or 2 A, 250 V AC) <sup>1)</sup>

Terminal No.	Signal	Features
<b>Analog inputs (AI)</b>		
3	AI0+	Differential input, switchable between current, voltage Value range: 0 ... 10 V, -10 ... +10 V, 0/2 ... 10 V, 0/4 ... 20 mA
4	AI0-	
10	AI1+	Differential input, switchable between current, voltage Value range: 0 ... 10 V, -10 ... +10 V, 0/2 ... 10 V, 0/4 ... 20 mA
11	AI1-	
50	AI2+	Non-isolated input, switchable between current and temperature sensors, type Pt1000/LG-Ni1000/DIN-Ni1000 Value range: 0/4 ... 20 mA, Pt1000: -88 ... +240 °C; LG-Ni1000/DIN-Ni1000: -88 ... +165 °C
51	GND	
52	AI3+	Non-isolated input for temperature sensors, type Pt1000/LG-Ni1000/DIN-Ni1000 Value range: Pt1000: -88 ... +240 °C; LG-Ni1000/DIN-Ni1000: -88 ... +165 °C
53	GND	
<b>Analog outputs (AO)</b>		
12	AO0+	Non-isolated output Freely programmable Value range: 0 ... 10 V; 0/4 ... 20 mA
13	GND	
26	AO1+	Non-isolated output Freely programmable Value range: 0 ... 10 V; 0/4 ... 20 mA
27	GND	
<b>PTC/KTY interface</b>		
14	T1 MOTOR	Positive input for motor temperature sensor Type: PTC, Pt1000, KTY, bimetal
15	T2 MOTOR	Negative input for motor temperature sensor
<b>Power supply</b>		
9	+24 V OUT	Power supply output 24 V DC, max. 100 mA
28	GND	Reference potential of the power supply/ internal electronics ground
1	+10 V OUT	Power supply output 10 V DC ±0.5 V, max. 10 mA
2	GND	Reference potential of the power supply/ internal electronics ground
31	+24 V IN	Power supply input 20.4 ... 28.8 V DC, max. 1500 mA
32	GND IN	Reference potential of the power supply input
35	+10 V OUT	Power supply output 10 V DC ±0.5 V, max. 10 mA
36	GND	Reference potential of the power supply/ internal electronics ground

<sup>1)</sup> The following applies to systems complying with UL: A maximum of 3 A, 30 V DC or 2 A, 250 V AC may be connected via terminals 18 / 20 (DO0 NC) and 23 / 25 (DO2 NC).

## SINAMICS G120 standard converters

0.37 kW to 250 kW (0.5 hp to 400 hp)

### Control Units

#### Design

#### CU240E-2, CU240E-2 DP, CU240E-2 PN, CU240E-2 F, CU240E-2 DP-F and CU240E-2 PN-F Control Units



CU240E-2 Control Unit with open and closed terminal covers

Terminal No.	Signal	Features
<b>Digital inputs (DI) – Standard</b>		
5 ... 8, 16, 17	DI0 ... DI5	Freely programmable (isolated) 5.5 mA/24 V
69	DI COM1	Reference potential for digital inputs 0, 2, 4, 6
34	DI COM2	Reference potential for digital inputs 1, 3, 5, 7
<b>Digital inputs (DI) – Fail-safe (formed from two standard inputs using the appropriate parameter setting)</b>		
16, 17	F-DI0	Fail-safe digital inputs, 2 channels (redundant), freely programmable (isolated) 5.5 mA/24 V
The following are only available for CU240E-2 F, CU240E-2 DP-F and CU240E-2 PN-F		
5, 6	F-DI0	Fail-safe digital inputs, 2 channels (redundant), freely programmable (isolated) 5.5 mA/24 V
7, 8	F-DI1	Fail-safe digital inputs, 2 channels (redundant), freely programmable (isolated) 5.5 mA/24 V
16, 17	F-DI2	Fail-safe digital inputs, 2 channels (redundant), freely programmable (isolated) 5.5 mA/24 V

Terminal No.	Signal	Features
<b>Digital outputs (DO)</b>		
18	DO0, NC	Relay output DO0 NC contact (0.5 A, 30 V DC)
19	DO0, NO	Relay output DO0 NO contact (0.5 A, 30 V DC)
20	DO0, COM	Relay output DO0 Common contact (0.5 A, 30 V DC)
21	DO1+	Transistor output DO1 Positive (0.5 A, 30 V DC)
22	DO1-	Transistor output DO1 Negative (0.5 A, 30 V DC)
23	DO2, NC	Relay output DO2 NC contact (0.5 A, 30 V DC)
24	DO2, NO	Relay output DO2 NO contact (0.5 A, 30 V DC)
25	DO2, COM	Relay output DO2 Common contact (0.5 A, 30 V DC)
<b>Analog inputs (AI)</b>		
3	AI0+	Differential input, switchable between current, voltage Value range: 0 ... 10 V, -10 ... +10 V, 0/2 ... 10 V, 0/4 ... 20 mA
4	AI0-	
10	AI1+	Differential input, switchable between current, voltage Value range: 0 ... 10 V, -10 ... +10 V, 0/2 ... 10 V, 0/4 ... 20 mA
11	AI1-	
<b>Analog outputs (AO)</b>		
12	AO0+	Non-isolated output Freely programmable Value range: 0 ... 10 V; 0/4 ... 20 mA
13	GND	Reference potential of the AO0/ internal electronics ground
26	AO1+	Non-isolated output Freely programmable Value range: 0 ... 10 V; 0/4 ... 20 mA
27	GND	Reference potential of the AO1/ internal electronics ground
<b>PTC/KTY interface</b>		
14	T1 MOTOR	Positive input for motor temperature sensor Type: PTC, Pt1000, KTY, bimetal
15	T2 MOTOR	Negative input for motor temperature sensor
<b>Power supply</b>		
9	+24 V OUT	Power supply output 24 V DC, max. 100 mA
28	GND	Reference potential of the power supply/ internal electronics ground
1	+10 V OUT	Power supply output 10 V DC $\pm 0.5$ V, max. 10 mA
2	GND	Reference potential of the power supply/ internal electronics ground
31	+24 V IN	Power supply input 20.4 ... 28.8 V DC, max. 1500 mA
32	GND IN	Reference potential of the power supply input

## SINAMICS G120 standard converters

0.37 kW to 250 kW (0.5 hp to 400 hp)

### Control Units

#### Design

#### CU250S-2, CU250S-2 DP, CU250S-2 PN, CU250S-2 CAN Control Units



CU250S-2 Control Unit with open and closed terminal covers

Terminal No.	Signal	Features
<b>Digital inputs (DI)</b>		
5	DI0	Digital inputs, isolated, 5.5 mA/24 V
6	DI1+	Digital inputs, isolated, 5.5 mA/24 V
64	DI1-	Digital inputs, isolated, 5.5 mA/24 V
7	DI2	Digital inputs, isolated, 5.5 mA/24 V
8	DI3+	Digital inputs, isolated, 5.5 mA/24 V
65	DI3-	Digital inputs, isolated, 5.5 mA/24 V
16	DI4	Digital inputs, isolated, 5.5 mA/24 V
17	DI5+	Digital inputs, isolated, 5.5 mA/24 V
66	DI5-	Digital inputs, isolated, 5.5 mA/24 V
67	DI6	Digital inputs, isolated, 5.5 mA/24 V
69	DI COM1	Reference potential for digital inputs DI0, DI2, DI4, DI6
41 ... 44	DI16 ... DI19	Freely programmable (isolated) 5.5 mA/24 V
40	DI COM3	Reference potential for digital inputs DI16 ... DI19
<b>Digital inputs (DI) – Fail-safe (formed from two standard inputs using the appropriate parameter setting)</b>		
5, 6	F-DI0	Fail-safe digital inputs, 2 channels (redundant), freely programmable (isolated) 5.5 mA/24 V
7, 8	F-DI1	Fail-safe digital inputs, 2 channels (redundant), freely programmable (isolated) 5.5 mA/24 V
16, 17	F-DI2	Fail-safe digital inputs, 2 channels (redundant), freely programmable (isolated) 5.5 mA/24 V
69	DI COM1	Reference potential for digital inputs F-DI0, F-DI1, F-DI2
<b>Switchable digital inputs or outputs (digital inputs DI24 to DI27 can also be used as a pulse input with a maximum frequency of 32 kHz)</b>		
51	DI24/DO24	Freely programmable (not isolated), DI: 5.5 mA/24 V, DO: 100 mA/24 V
53	DI25/DO25	Freely programmable (not isolated), DI: 5.5 mA/24 V, DO: 100 mA/24 V
53	DI26/DO26	Freely programmable (not isolated), DI: 5.5 mA/24 V, DO: 100 mA/24 V
54	DI27/DO27	Freely programmable (not isolated), DI: 5.5 mA/24 V, DO: 100 mA/24 V
50	GND	Reference potential

Terminal No.	Signal	Features
<b>Digital outputs (DO)</b>		
18	DO0, NC	Relay output DO0 NC contact (0.5 A, 30 V DC)
19	DO0, NO	Relay output DO0 NO contact (0.5 A, 30 V DC)
20	DO0, COM	Relay output DO0 Common contact (0.5 A, 30 V DC)
21	DO1 NO	Relay output DO1 NO contact (0.5 A, 30 V DC)
22	DO1 COM	Relay output DO1 Common contact (0.5 A, 30 V DC)
23	DO2, NC	Relay output DO2 NC contact (0.5 A, 30 V DC)
24	DO2, NO	Relay output DO2 NO contact (0.5 A, 30 V DC)
25	DO2, COM	Relay output DO2 Common contact (0.5 A, 30 V DC)
<b>Digital output (DO) – Fail-safe (formed from two standard outputs using the appropriate parameter setting)</b>		
18, 23	F-DO0, NC	Relay output F-DO0 NC contact (0.5 A, 30 V DC), 2-channel (redundant)
19, 24	F-DO0, NO	Relay output F-DO0 NO contact (0.5 A, 30 V DC), 2-channel (redundant)
20, 25	F-DO0, COM	Relay output F-DO0 common contact (0.5 A, 30 V DC), 2-channel (redundant)
<b>Analog inputs (AI)</b>		
3	AI0+	Differential input, switchable between current, voltage
4	AI0-	Value range: 0 ... 10 V, -10 ... +10 V, 0/2 ... 10 V, 0/4 ... 20 mA
10	AI1+	Differential input, switchable between current, voltage
11	AI1-	Value range: 0 ... 10 V, -10 ... +10 V, 0/2 ... 10 V, 0/4 ... 20 mA
13	GND	Reference potential of AI
<b>Analog outputs (AO)</b>		
12	AO0+	Non-isolated output Freely programmable Value range: 0 ... 10 V; 0/4 ... 20 mA
26	AO1+	Non-isolated output Freely programmable Value range: 0 ... 10 V; 0/4 ... 20 mA
27	GND	Reference potential of AO
<b>PTC/KTY interface</b>		
14	T1 MOTOR	Positive input for motor temperature sensor Type: PTC, Pt1000, KTY, bimetal
15	T2 MOTOR	Negative input for motor temperature sensor
<b>Power supply</b>		
9	+24 V OUT	Power supply output 24 V DC, max. 200 mA
28	GND	Reference potential of the power supply/ internal electronics ground
1	+10 V OUT	Power supply output 10 V DC $\pm 0.5$ V, max. 10 mA
2	GND	Reference potential of the power supply/ internal electronics ground
31	+24 V IN	Power supply input 20.4 ... 28.8 V DC, max. 1500 mA
32	GND IN	Reference potential of the power supply input



## SINAMICS G120 standard converters

0.37 kW to 250 kW (0.5 hp to 400 hp)

### Control Units

#### Design

Terminal No.	Signal	Features
<b>HTL encoder/resolver interface via terminal</b>		
33	ENC+	HTL encoder power supply
79	GND	Reference potential
70	AP/S2	HTL track A+ / resolver signal A (sin+)
71	AN/S4	HTL track A- / inverted resolver signal A (sin-)
72	BP/S1	HTL track B+ / resolver signal S1
73	BN/S3	HTL track B- / inverted resolver signal B (cos-)
74	ZP	HTL zero signal+
75	ZN	HTL zero signal-
76	R1	Resolver excitation+
77	R2	Resolver excitation-

Terminal No.	Signal
<b>DRIVE-CLiQ</b>	
1	Transmit data +
2	Transmit data -
3	Receive data +
4	–
5	–
6	Receive data -
7	–
8	–
A	+24 V power supply
B	M, reference for power supply

Terminal No.	Signal	HTL	TTL	SSI (RS422 standard)	PTC, Pt1000, KTY84, bimetal
<b>HTL, TTL, SSI, temperature via SUB-D interface</b>					
1	Motor temperature sensing +	–	–	–	Temp +
2	SSI clock	–	–	Clock +	–
3	Inverse SSI clock	–	–	Clock -	–
4	5 V/24 V encoder supply	P encoder	P encoder	P encoder	–
5	5 V/24 V encoder supply	P encoder	P encoder	P encoder	–
6	Sense input, encoder supply	–	P sense	–	–
7	0 V, reference for encoder supply	M encoder	M encoder	M encoder	–
8	Motor temperature sensing -	–	–	–	Temp-
9	0 V, reference for sense input	–	M sense	–	–
10	Referencing signal	R +	R +	–	–
11	Inverted referencing signal	R -	R -	–	–
12	Inverted incremental signal B	B -	B -	–	–
13	Incremental signal B	B +	B +	–	–
14	Inverted incremental signal A / SSI data	A -	A -	Data -	–
15	Incremental signal A / SSI data	A +	A +	Data +	–

## SINAMICS G120 standard converters

0.37 kW to 250 kW (0.5 hp to 400 hp)

### Control Units

#### Function

##### Function module **basic positioner EPos**

The basic positioner EPos is available as a standard technology function for the following SINAMICS Control Units and can be called as a function module that can be activated additionally.

- SINAMICS S120 CU310-2 and CU320-2 Control Units
- SINAMICS S110 CU305 Control Units
- SINAMICS G120 CU250S-2 Control Units
- SINAMICS G120D CU250D-2 Control Units

The basic positioner can be used to resolve basic motion control tasks without additional external technological outlay from the drive itself.

Integrated functionality for absolute and relative positioning of linear and rotary axes with motor encoders or machine encoders.

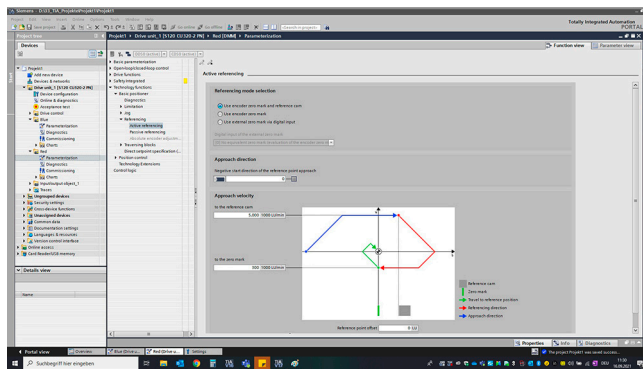
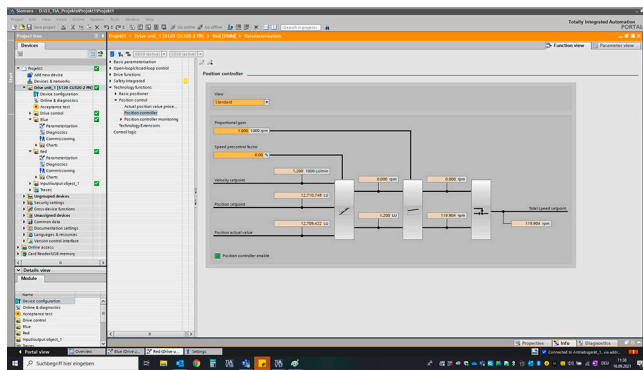

The EPos basic positioner in the SINAMICS drive system provides powerful and precise positioning functions. Due to its flexibility and adaptability, the basic positioner can be used for a wide range of positioning tasks.

The functions are easy to handle both during commissioning and during operation, and the comprehensive monitoring functions are outstanding.

Many applications can be carried out without external position controllers.

The EPos basic positioner is used to position linear and rotary axes (modulo) in absolute/relative terms with rotary as well as linear motor encoder or machine encoder (indirect or direct measuring system).

EPos is a function module that can be activated additionally in Servo Control and in Vector Control.

User-friendly configuring and commissioning, including control panel (operation using PC) and diagnostics, are possible with the STARTER and SINAMICS Startdrive commissioning tools.

In addition to extremely flexible positioning functions, EPos offers a high degree of user-friendliness and reliability thanks to integral monitoring and compensation functions.

Different operating modes and their functionality increase flexibility and plant productivity, for example, by means of "on-the-fly" and bumpless correction of the motion control.

Preconfigured PROFIdrive positioning frames are available which, when selected, automatically establish the internal "connection" to the basic positioner.

## Function

### Functionality of the EPos basic positioner

#### Lower-level closed-loop position control with the following essential components

- Position actual value sensing (including the lower-level measuring probe evaluation and reference mark search)
- Position controller (including limits, adaptation and pre-control calculation)
- Monitoring functions (standstill, positioning and dynamic following error monitoring, cam signals)

#### Mechanical system

- Backlash compensation
- Modulo offset

#### Limitations

- Speed/acceleration/delay/jerk limitation
- Software limit switches (traversing range limitation by means of position setpoint evaluation)
- Stop cams (traversing range limitation using hardware limit switch evaluation)

#### Referencing or adjustment

- Set reference point (for an axis at standstill)
- Search for reference (separate mode including reversing cam functionality, automatic reversal of direction, homing to "output cam and encoder zero mark" or only "encoder zero mark" or "external zero mark (BERO)")
- Flying referencing (seamless referencing possible during "normal" traversing with the aid of the measuring input evaluation; generally evaluation, e.g. of a BERO. Subordinate function for the modes "jog", "direct setpoint input/MDI" and "traversing blocks")
- Absolute encoder alignment

#### Traversing block mode

- 64 traversing blocks for
  - SINAMICS S120 CU310-2 and CU320-2 Control Units
- 16 traversing blocks for
  - SINAMICS S110 CU305 Control Units
  - SINAMICS G120 CU250S-2 Control Units
  - SINAMICS G120D CU250D-2 Control Units
- Positioning using traversing blocks that can be stored in the drive unit including continuation conditions and specific jobs for a previously homed axis
- Configuring traversing blocks using the traversing block editor in the relevant commissioning tool of the SINAMICS converter family
- A traversing block contains the following information:
  - Job number and job (e.g. positioning, waiting, GOTO block jump, setting of binary outputs, travel to fixed stop)
  - Motion parameters (target position, velocity, override for acceleration and deceleration)
  - Mode (e.g.: hide block, continuation conditions such as "Continue\_with\_stop", "Continue\_flying" and "Continue\_externally using high-speed measuring inputs")
  - Job parameters (e.g. wait time, block step conditions)

#### Direct setpoint specification (MDI) mode

- Positioning (absolute, relative) and setting-up (endless closed-loop position control) using direct setpoint inputs (e.g. via the PLC using process data)
- It is always possible to influence the motion parameters during traversing (on-the-fly setpoint acceptance) as well as for on-the-fly changes between the setup and positioning modes.
- The direct setpoint specification mode (MDI) can also be used in the relative positioning or setup mode if the axis is not referenced. This means that on-the-fly synchronization and re-referencing can be carried out using "flying referencing".

#### Jog mode

- Closed-loop position controlled traversing of the axis with "endless position controlled" or "jog incremental" modes (traverse through a "step width"), which can be toggled between

Further information can be found in the section [Technology functions](#).

# SINAMICS G120 standard converters

0.37 kW to 250 kW (0.5 hp to 400 hp)

## Control Units

### Integration

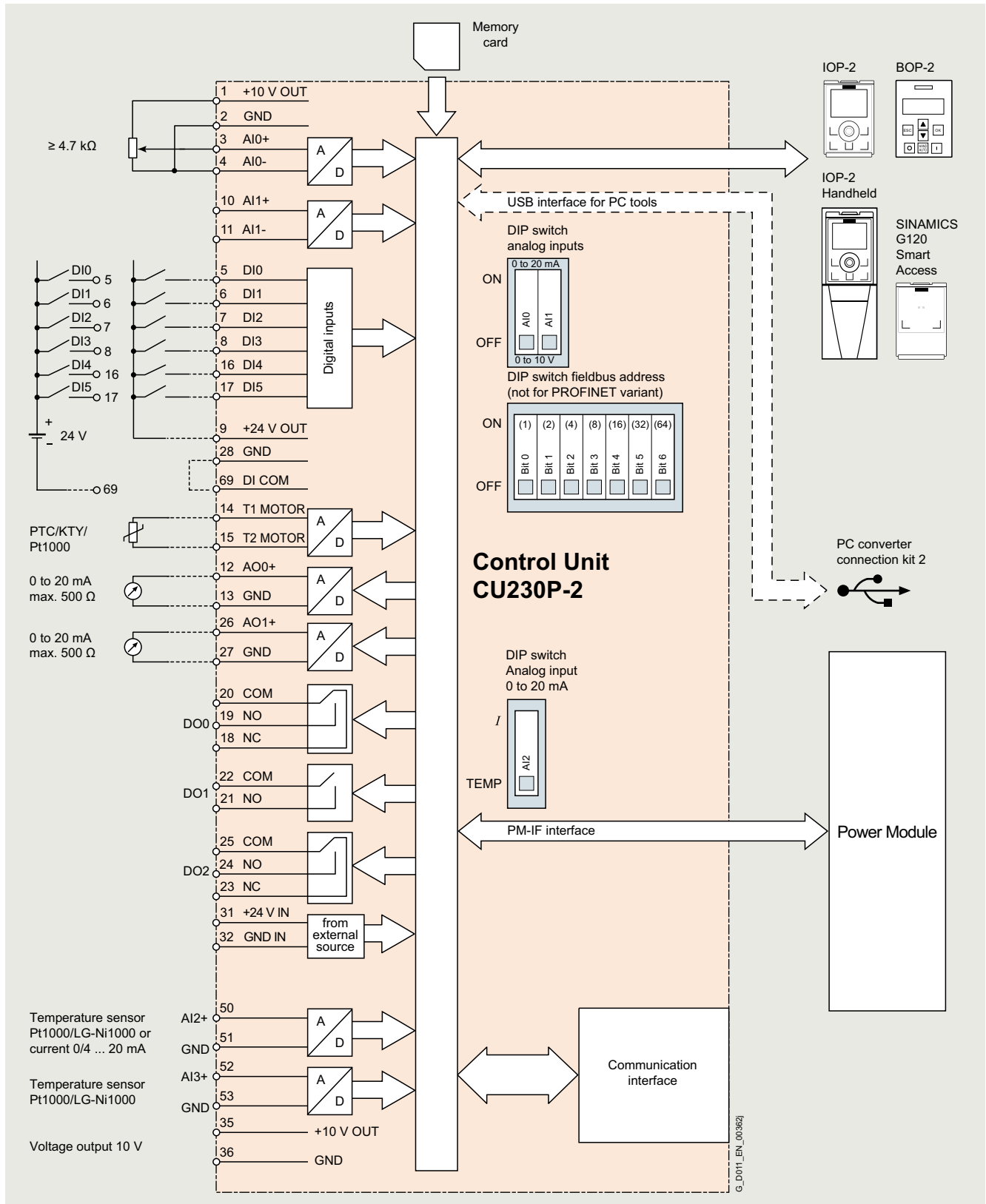

Connection example of a CU230P-2 series Control Unit

More information about the interfaces of the Control Unit is available on the internet at:

<https://support.industry.siemens.com/cs/document/109477360>

**Integration**

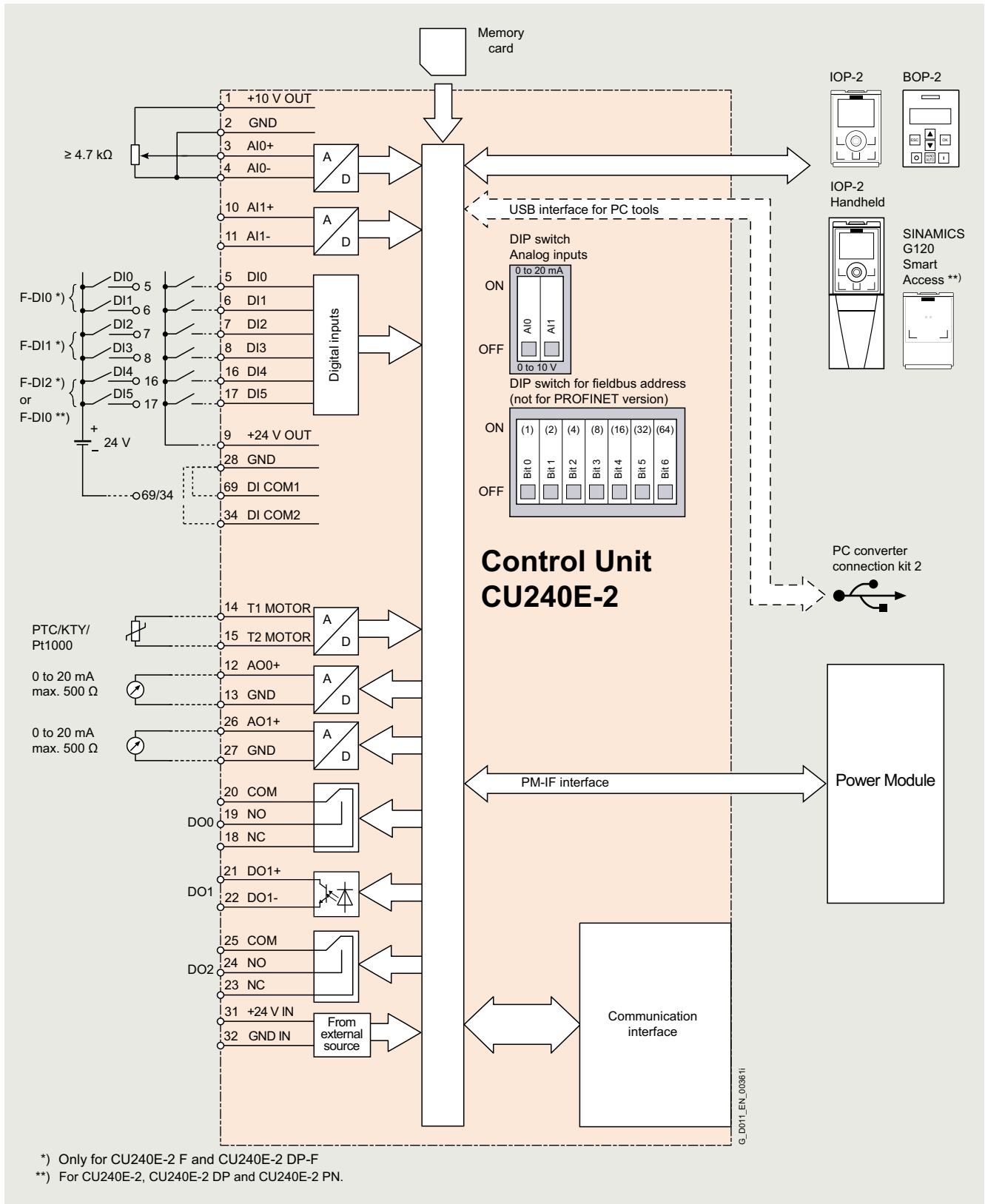

Connection example of a CU240E-2 series Control Unit  
More information about the interfaces of the Control Unit is available on the internet at:  
<https://support.industry.siemens.com/cs/document/109477361>

# SINAMICS G120 standard converters

0.37 kW to 250 kW (0.5 hp to 400 hp)

## Control Units

### Integration

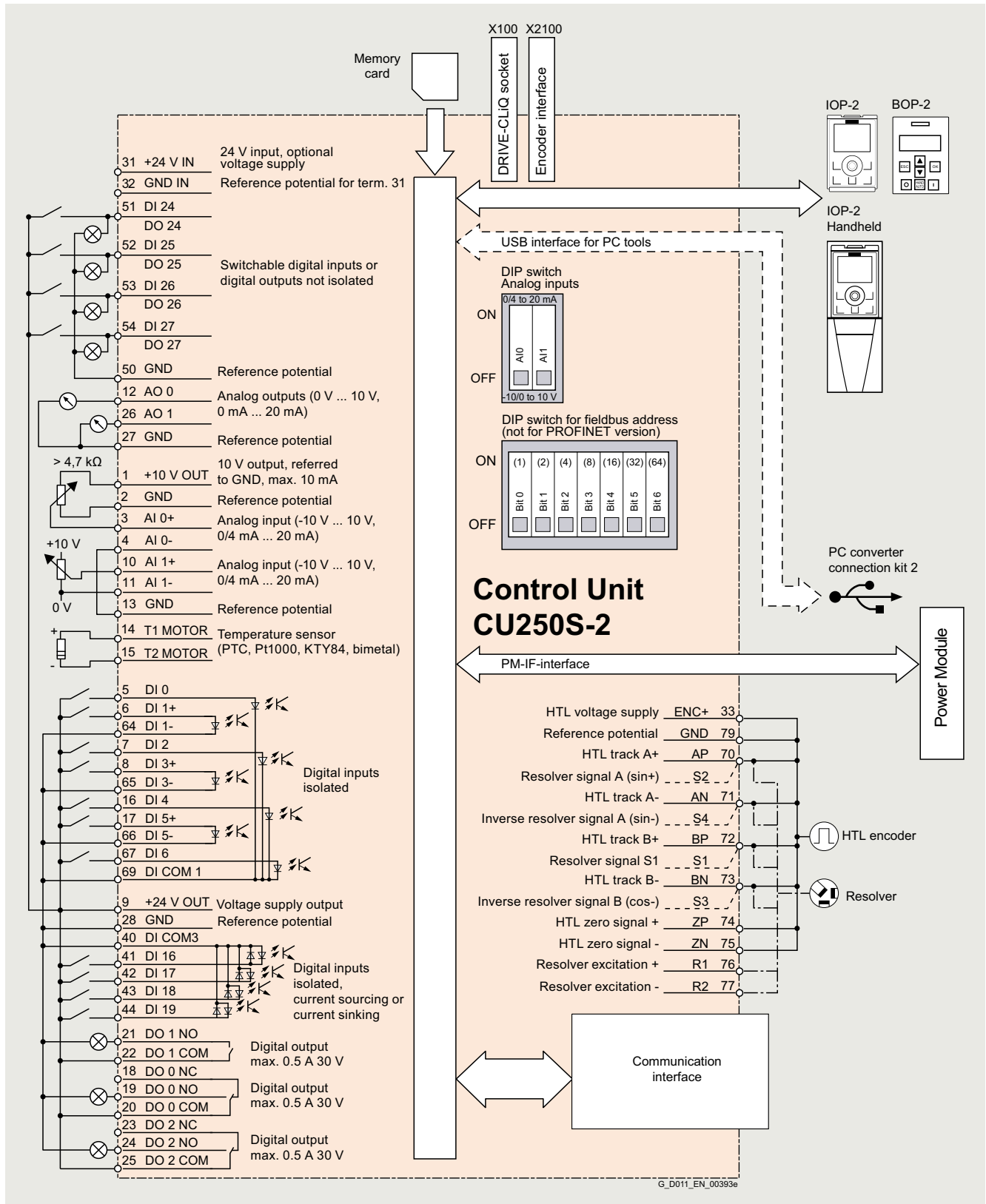

Connection example of a CU250S-2 series Control Unit

More information about the interfaces of the Control Unit is available on the internet at: <https://support.industry.siemens.com/cs/document/99730303>

# SINAMICS G120 standard converters

0.37 kW to 250 kW (0.5 hp to 400 hp)

## Control Units

### Integration

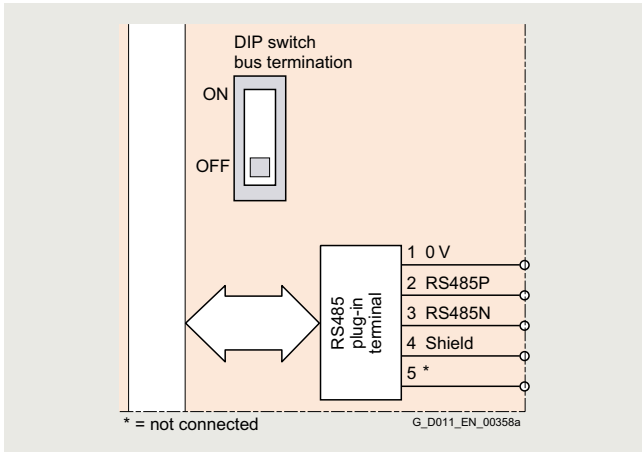

Communication interface USS, Modbus RTU, BACnet MS/TP, FLN P1 (BACnet MS/TP and FLN P1 for CU230P-2 HVAC only)

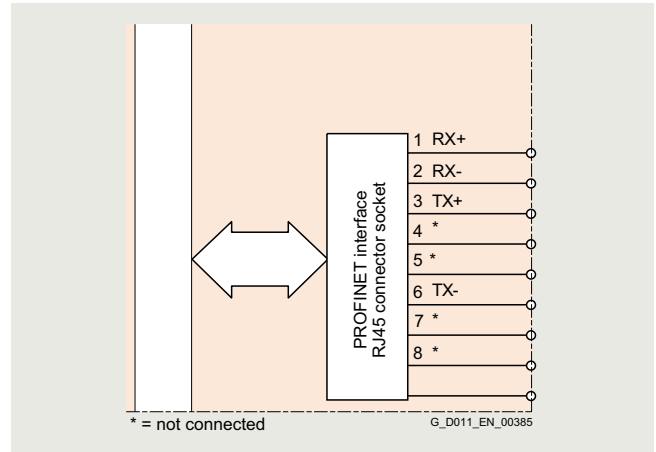

Communication interface PROFINET, EtherNet/IP

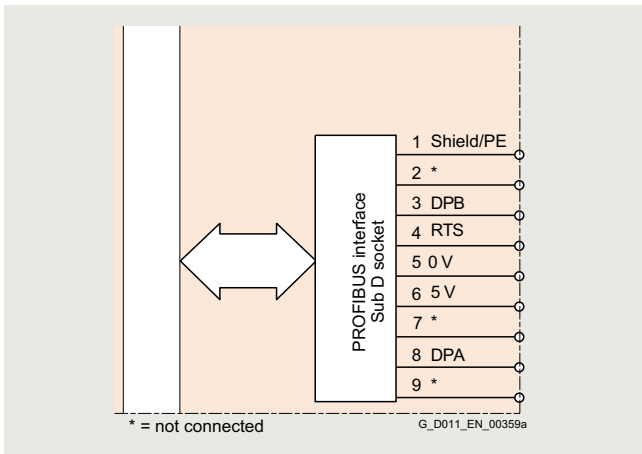

PROFIBUS DP communication interface

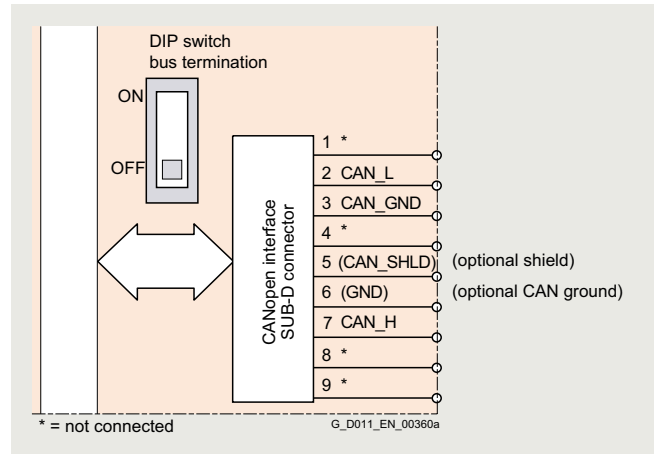

CANopen communication interface (only for CU250S-2)

## SINAMICS G120 standard converters

0.37 kW to 250 kW (0.5 hp to 400 hp)

### Control Units

#### Selection and ordering data

Designation	Fieldbus	Profile	Inputs Outputs	Integrated safety technology	Fail-safe digital inputs digital outputs	Control Unit  Article No.
<b>CU230P-2 series - the specialist for pumps, fans, compressors, water, buildings</b>						
Technology functions (selection): Free function blocks (FFB), 4 × PID controller, cascade connection, hibernation mode, essential service mode, multi-zone control						
<b>CU230P-2 HVAC</b>	<ul style="list-style-type: none"> <li>• USS</li> <li>• Modbus RTU</li> <li>• BACnet MS/TP</li> <li>• FLN P1</li> </ul>	–	6 DI 4 AI  3 DO 2 AO	–	–	<b>6SL3243-0BB30-1HA3</b>
<b>CU230P-2 DP</b>	<ul style="list-style-type: none"> <li>• PROFIBUS DP</li> </ul>	<ul style="list-style-type: none"> <li>• PROFIdrive</li> </ul>				<b>6SL3243-0BB30-1PA3</b>
<b>CU230P-2 PN</b>	<ul style="list-style-type: none"> <li>• PROFINET</li> </ul>	<ul style="list-style-type: none"> <li>• PROFIdrive</li> <li>• PROFInergy</li> </ul>				<b>6SL3243-0BB30-1FA0</b>
	<ul style="list-style-type: none"> <li>• EtherNet/IP</li> <li>- ODVA AC Drive</li> <li>- SINAMICS profile</li> </ul>	–				
<b>CU240E-2 series – for standard applications in general machinery construction, such as conveyor belts, mixers and extruders – without encoder</b>						
Technology functions (selection): Free function blocks (FFB), 1 × PID controller, motor holding brake						
<b>CU240E-2</b>	<ul style="list-style-type: none"> <li>• USS</li> <li>• Modbus RTU</li> </ul>	–	6 DI 2 AI  3 DO 2 AO	STO	1 F-DI (opt. for each 2 DI)	<b>6SL3244-0BB12-1BA1</b>
<b>CU240E-2 DP</b>	<ul style="list-style-type: none"> <li>• PROFIBUS DP</li> </ul>	<ul style="list-style-type: none"> <li>• PROFIdrive</li> <li>• PROFIsafe</li> </ul>				<b>6SL3244-0BB12-1PA1</b>
<b>CU240E-2 PN</b>	<ul style="list-style-type: none"> <li>• PROFINET</li> </ul>	<ul style="list-style-type: none"> <li>• PROFIdrive</li> <li>• PROFIsafe</li> <li>• PROFInergy</li> </ul>				<b>6SL3244-0BB12-1FA0</b>
	<ul style="list-style-type: none"> <li>• EtherNet/IP</li> <li>- ODVA AC Drive</li> <li>- SINAMICS profile</li> </ul>	–				
<b>CU240E-2 F</b>	<ul style="list-style-type: none"> <li>• USS</li> <li>• Modbus RTU</li> </ul>	–		STO, SS1, SLS, SDI	3 F-DI (opt. for each 2 DI)	<b>6SL3244-0BB13-1BA1</b>
<b>CU240E-2 DP-F</b>	<ul style="list-style-type: none"> <li>• PROFIBUS DP</li> </ul>	<ul style="list-style-type: none"> <li>• PROFIdrive</li> <li>• PROFIsafe</li> </ul>		STO, SS1, SLS, SSM <sup>1)</sup> , SDI		<b>6SL3244-0BB13-1PA1</b>
<b>CU240E-2 PN-F</b>	<ul style="list-style-type: none"> <li>• PROFINET</li> </ul>	<ul style="list-style-type: none"> <li>• PROFIdrive</li> <li>• PROFIsafe</li> <li>• PROFInergy</li> </ul>				<b>6SL3244-0BB13-1FA0</b>
	<ul style="list-style-type: none"> <li>• EtherNet/IP</li> <li>- ODVA AC Drive</li> <li>- SINAMICS profile</li> </ul>	–				
<b>CU250S-2 series – for complex applications such as extruders and centrifuges – with and without encoder (basic positioner (EPos) optional)</b>						
Technology functions (selection): Free function blocks (FFB), 1 × PID controller, motor holding brake						
<b>CU250S-2</b>	<ul style="list-style-type: none"> <li>• USS</li> <li>• Modbus RTU</li> </ul>	–	11 DI 2 AI  3 DO 2 AO	STO, SBC, SS1	3 F-DI (opt. for each 2 DI)	<b>6SL3246-0BA22-1BA0</b>
<b>CU250S-2 DP</b>	<ul style="list-style-type: none"> <li>• PROFIBUS DP</li> </ul>	<ul style="list-style-type: none"> <li>• PROFIdrive</li> <li>• PROFIsafe</li> </ul>			1 F-DO (opt. for each 2 DO)	<b>6SL3246-0BA22-1PA0</b>
<b>CU250S-2 PN</b>	<ul style="list-style-type: none"> <li>• PROFINET</li> </ul>	<ul style="list-style-type: none"> <li>• PROFIdrive</li> <li>• PROFIsafe</li> <li>• PROFInergy</li> </ul>	4 DI/DO (DI can be used as high-speed inputs)			<b>6SL3246-0BA22-1FA0</b>
	<ul style="list-style-type: none"> <li>• EtherNet/IP</li> <li>- ODVA AC Drive</li> <li>- SINAMICS profile</li> </ul>	–				
<b>CU250S-2 CAN</b>	<ul style="list-style-type: none"> <li>• CANopen</li> </ul>	–				<b>6SL3246-0BA22-1CA0</b>

<sup>1)</sup> SSM is only possible with PROFIsafe.



## Selection and ordering data

### Optional memory card with firmware V4.7 SP13 or V4.7 SP14 for CU230P-2, CU240E-2 and CU250S-2 Control Units

Designation	Suitable for	Article No.
<b>SINAMICS SD card 512 MB + firmware V4.7 SP13</b> (Multicard V4.7 SP13)	CU230P-2 CU240E-2 CU250S-2	<b>6SL3054-7TG00-2BA0</b>
<b>SINAMICS SD card 512 MB + firmware V4.7 SP14</b> (Multicard V4.7 SP14)	CU230P-2 CU240E-2 CU250S-2	<b>6SL3054-7TH00-2BA0</b>

### Optional memory cards with licenses for CU250S-2 Control Units only

Designation	SINAMICS SD card 512 MB + licenses <sup>1)</sup>	SINAMICS SD card 512 MB + firmware V4.7 SP13 (Multicard V4.7 SP13) + licenses <sup>1)</sup>	SINAMICS SD card 512 MB + firmware V4.7 SP14 (Multicard V4.7 SP14) + licenses <sup>1)</sup>	Licenses (without SD card) for upgrading license of an existing SD card <sup>2)</sup>
	Article No.	Article No.		Article No.
<b>License</b> Extended Functions Basic positioner (EPos) • CoL in electronic form	<b>6SL3054-4AG00-2AA0-Z E01</b>	<b>6SL3054-7TG00-2BA0-Z E01</b>	<b>6SL3054-7TH00-2BA0-Z E01</b>	<b>6SL3074-7AA04-0AH0</b>
<b>License</b> Extended Functions Safety (SLS, SSM, SDI) • CoL in electronic form	<b>6SL3054-4AG00-2AA0-Z F01</b>	<b>6SL3054-7TG00-2BA0-Z F01</b>	<b>6SL3054-7TH00-2BA0-Z F01</b>	<b>6SL3074-0AA10-0AH0</b>
<b>Licenses</b> Extended Functions Basic positioner (EPos) + Safety (SLS, SSM, SDI) • CoL in electronic form	<b>6SL3054-4AG00-2AA0-Z E01+F01</b>	<b>6SL3054-7TG00-2BA0-Z E01+F01</b>	<b>6SL3054-7TH00-2BA0-Z E01+F01</b>	–

More information on firmware V4.7 SP13:  
<https://support.industry.siemens.com/cs/document/109781149>

More information on firmware V4.7 SP14:  
<https://support.industry.siemens.com/cs/document/109817231>

For an overview and more information on all available firmware versions, see  
<https://support.industry.siemens.com/cs/document/67364620>

<sup>1)</sup> The Certificate of License (CoL) is located on the SINAMICS SD card. In addition, notification of an optional download is received by email.

<sup>2)</sup> With a CoL in electronic form, the license is supplied as a PDF file. Notification of this with a download link is received by email.

## SINAMICS G120 standard converters

0.37 kW to 250 kW (0.5 hp to 400 hp)

### Control Units

#### Selection and ordering data

##### More information

The **Certificate of License (CoL)** is the licensee's proof that the use of the software has been licensed by Siemens. A CoL must be assigned to each use and must be kept in a safe place.

##### Electronic Certificate of License

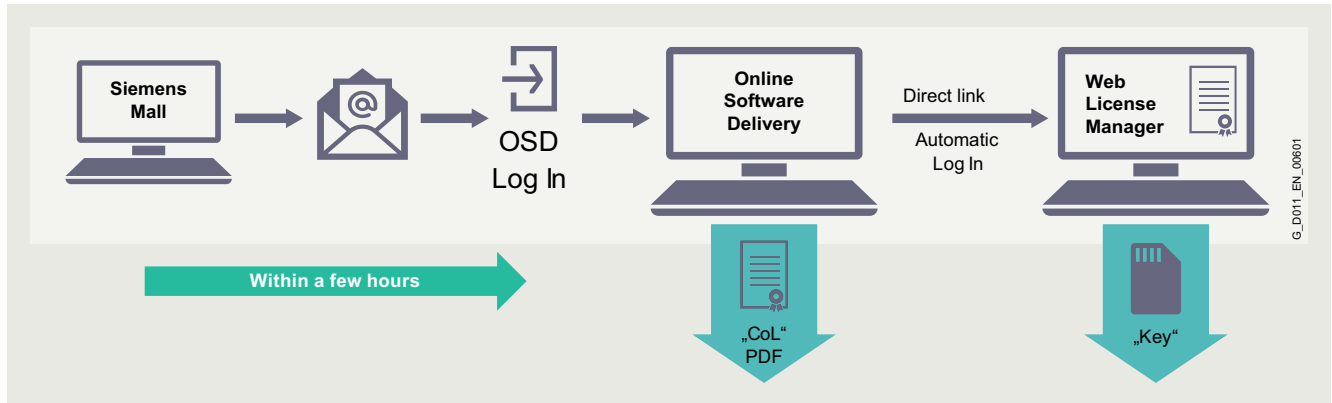

Electronic Certificate of License: Procedure for order licenses

The electronic Certificate of License (eCoL) is the paperless delivery form for runtime options for SINAMICS and SINUMERIK.

Like the previous paper Certificate of License CoL, the electronic Certificate of License contains information about the type of rights of use purchased for the software. The electronic Certificate of License is supplied as a PDF file via the Online Software Delivery Portal (OSD). This enables quick notification with a download link to the email address to be stated in the order.

The electronic Certificate of License can then be downloaded from the OSD. The Web License Manager can also be called from the OSD to assign the runtime license to a memory card. In this case, the data of the electronic Certificate of License are automatically transferred to the Web License Manager and do not have to be entered manually.

This ensures quick availability of the license key and simple and secure handling and management of the license certificates.

You will find information on the OSD at:

<https://support.industry.siemens.com/cs/ww/en/view/109759444>

In the future, the pre-licensed memory cards will also be delivered with the corresponding electronic Certificates of License on the memory card. The Certificates of License are stored in directory "KEYS". The pre-licensed memory cards will successively make the transition from paper CoLs to electronic CoLs. The CoL on paper will then no longer be contained in the delivery.

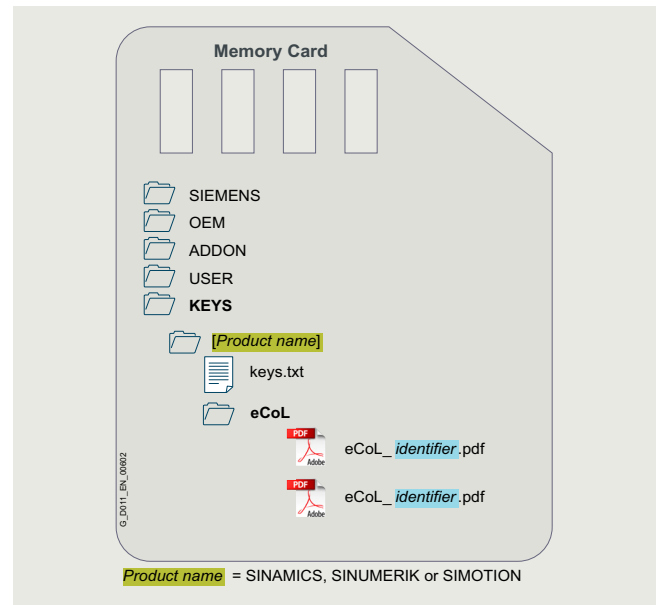

Electronic Certificate of License: Storage location on data medium

# SINAMICS G120 standard converters

0.37 kW to 250 kW (0.5 hp to 400 hp)

## Control Units

### Technical specifications

Control Unit	CU230P-2 series 6SL3243-0BB30-1 . A3 6SL3243-0BB30-1FA0	CU240E-2 series 6SL3244-0BB1 . -1 . A1 6SL3244-0BB1 . -1FA0	CU250S-2 series 6SL3246-0BA22-1 . A0
<b>Electrical specifications</b>			
<b>Operating voltage</b>	24 V DC via the Power Module or by connecting to an external 20.4 ... 28.8 V DC power supply		
<b>Current consumption, max.</b>	0.5 A	0.5 A	1.5 A
<b>Protective insulation</b>	PELV according to EN 50178 Protective separation from the line supply using double/reinforced insulation		
<b>Power loss, max.</b>	5 W	5 W	12 W
<b>Interfaces</b>			
<b>Digital inputs – Standard</b>	6 isolated inputs	6 isolated inputs	11 isolated inputs +4 switchable DI/DO, non-isolated (DI can be used as high-speed inputs)
	Optically isolated, free reference potential (own potential group), input current 5.5 mA NPN/PNP logic can be selected using the wiring Switching level: 0 → 1: 11 V Switching level: 1 → 0: 5 V		
<b>Digital inputs – Fail-safe</b>	–	1 (use of 2 × DI standard) Max. 3 (use of 6 × DI standard) for CU240E-2 F, CU240E-2 PN-F and CU240E-2 DP-F	1 (use of 2 × DI standard) Max. 3 (use of 6 × DI standard)
<b>Digital outputs</b>	2 relay changeover contacts 250 V AC, 2 A (inductive load), 30 V DC, 5 A (ohmic load) The following applies to systems complying with UL: A maximum of 3 A, 30 V DC or 2 A, 250 V AC may be connected via terminals 18 / 20 (DO0 NC) and 23 / 25 (DO2 NC)  1 relay NO contact 30 V DC, 0.5 A (ohmic load)	1 transistor 30 V DC, 0.5 A (ohmic load)  2 relay changeover contacts 30 V DC, 0.5 A (ohmic load)	2 relay changeover contacts 30 V DC, 0.5 A (ohmic load)  1 relay NO contact 30 V DC, 0.5 A (ohmic load)
<b>Digital outputs – Fail-safe</b>	–	–	1 (use of 2 × DO standard)
<b>Analog inputs – standard</b>	2 differential inputs  Switchable using DIP switch between voltage and current: -10 ... +10 V, 0/4 ... 20 mA, 12-bit resolution (with CU250S-2: 13-bit resolution)  The differential analog inputs can be configured as additional digital inputs. Switching thresholds: 0 → 1: Rated voltage 4 V 1 → 0: Rated voltage 1.6 V	2 differential inputs	2 differential inputs
<b>Analog inputs – switchable: Temperature sensor/current</b>	1 non-isolated input, switchable using DIP switch between current 0/4 ... 20 mA and temperature sensor, type Pt1000/LG-Ni1000/DIN-Ni1000, 12-bit resolution	–	–
<b>Analog inputs – temperature sensor</b>	1 non-isolated input, temperature sensor, type Pt1000/LG-Ni1000/DIN-Ni1000, 12-bit resolution	–	–
<b>Analog outputs</b>	2 non-isolated outputs  Switchable between voltage and current using parameter setting: 0 ... 10 V, 0/4 ... 20 mA  Voltage mode: 10 V, min. burden 10 kΩ Current mode: 20 mA, max. burden 500 Ω  The analog outputs have short-circuit protection	2 non-isolated outputs	2 non-isolated outputs
<b>PTC/KTY interface</b>	1 motor temperature sensor input, connectable sensors PTC, Pt1000, KTY and bimetal, accuracy ±5 °C	1 motor temperature sensor input, connectable sensors PTC, Pt1000, KTY and bimetal, accuracy ±5 °C	2 motor temperature sensor inputs, connectable sensors PTC, Pt1000, KTY and bimetal, accuracy ±5 °C • 1 input via terminal 14/15 • 1 input via SUB-D encoder interface X2100
<b>Removable terminal connector for I/O interface</b>	–	✓	✓

# SINAMICS G120 standard converters

0.37 kW to 250 kW (0.5 hp to 400 hp)

## Control Units

### Technical specifications

Control Unit	CU230P-2 series 6SL3243-0BB30-1 . A3 6SL3243-0BB30-1FA0	CU240E-2 series 6SL3244-0BB1 . -1 . A1 6SL3244-0BB1 . -1FA0	CU250S-2 series 6SL3246-0BA22-1 . A0
<b>Integrated bus interface</b>			
<b>USS, Modbus RTU</b> RS485 connected at a terminal, isolated, bus terminating resistor can be switched in, device address can be set using DIP switches USS: max. 187.5 kBaud Modbus RTU: 19.2 kBaud	CU230P-2 HVAC 6SL3243-0BB30-1HA3	CU240E-2 6SL3244-0BB12-1BA1 CU240E-2 F 6SL3244-0BB13-1BA1	CU250S-2 6SL3246-0BA22-1BA0
<b>BACnet MS/TP, FLN P1</b> RS485 connected to a terminal, isolated, bus terminating resistor can be switched in Max. 187.5 kBaud	CU230P-2 HVAC 6SL3243-0BB30-1HA3	–	–
<b>PROFIBUS DP</b> - PROFIdrive profile 9-pin SUB-D socket, isolated, PROFIdrive profile V4.1, device address can be set using DIP switches Max. 12 Mbit/s	CU230P-2 DP 6SL3243-0BB30-1PA3	CU240E-2 DP 6SL3244-0BB12-1PA1 incl. PROFIsafe CU240E-2 DP-F 6SL3244-0BB13-1PA1 incl. PROFIsafe	CU250S-2 DP 6SL3246-0BA22-1PA0 incl. PROFIsafe
<b>PROFINET</b> - PROFIdrive profile - PROFINergy profile 2 × RJ45, PROFIdrive profile V4.1, device name can be stored on the device Max. 100 Mbit/s (full duplex)	CU230P-2 PN 6SL3243-0BB30-1FA0	CU240E-2 PN 6SL3244-0BB12-1FA0 incl. PROFIsafe CU240E-2 PN-F 6SL3244-0BB13-1FA0 incl. PROFIsafe	CU250S-2 PN 6SL3246-0BA22-1FA0 incl. PROFIsafe
<b>EtherNet/IP</b> - ODVA AC drive - SINAMICS profile	CU230P-2 PN 6SL3243-0BB30-1FA0	CU240E-2 PN 6SL3244-0BB12-1FA0 CU240E-2 PN-F 6SL3244-0BB13-1FA0	CU250S-2 PN 6SL3246-0BA22-1FA0
<b>CANopen</b> 9-pin SUB-D connector, isolated, device address can be set using DIP switches, bus terminating resistor can be switched in Max. 1 Mbit/s	–	–	CU250S-2 CAN 6SL3246-0BA22-1CA0
<b>Tool interfaces</b>			
<b>Memory card</b>	SINAMICS SD card		
<b>Operator panels</b>	<ul style="list-style-type: none"> <li>• IOP-2 supported connection options between Control Unit and IOP-2: Can be directly plugged on, door mounting or handheld</li> <li>• BOP-2 Supported connection options between Control Unit and BOP-2: can be directly plugged on or door-mounted</li> <li>• SINAMICS G120 Smart Access Supported connection options between CU230P-2 and CU240E-2 Control Units and SINAMICS G120 Smart Access: Can be directly plugged on for wireless commissioning, operation and diagnostics via mobile device</li> </ul>		
<b>PC interface</b>	USB (connection via PC converter connection kit 2)		
<b>Open-loop/closed-loop control techniques</b>			
<b>V/f linear/square/parameterizable</b>	✓		
<b>V/f with flux current control (FCC)</b>	✓		
<b>V/f ECO; linear/square-law</b>	✓		
<b>Vector control, sensorless</b>	✓		
<b>Vector control, with sensor</b>	–	–	✓
<b>Torque control, sensorless</b>	–	✓	✓
<b>Torque control, with sensor</b>	–	–	✓
<b>Software functions</b>			
<b>Application macro</b>	✓		
<b>Setpoint input, can be parameterized</b>	✓		
<b>Fixed frequencies</b>	16, parameterizable		
<b>JOG</b>	✓		
<b>Digital motorized potentiometer (MOP)</b>	✓		
<b>Ramp smoothing</b>	✓		
<b>Extended ramp-function generator (with ramp smoothing OFF3)</b>	✓		

# SINAMICS G120 standard converters

0.37 kW to 250 kW (0.5 hp to 400 hp)

## Control Units

### Technical specifications

Control Unit	CU230P-2 series 6SL3243-0BB30-1 . A3 6SL3243-0BB30-1FA0	CU240E-2 series 6SL3244-0BB1 . -1 . A1 6SL3244-0BB1 . -1FA0	CU250S-2 series 6SL3246-0BA22-1 . A0
<b>Software functions (continued)</b>			
Slip compensation	✓		
Signal interconnection with BICO technology	✓		
Trace	✓		
Energy saving display	✓		
Switchable drive data sets (DDS)	✓ (4)		
Switchable command data sets (CDS)	✓ (4)		
Free function blocks (FFB) for logical and arithmetic operations	✓		
Technology controller (internal PID)	✓		
3 additional, free PID controllers	✓	–	–
2-zone controller	✓	–	–
Flying restart	✓		
Automatic restart after line supply failure or operating fault (AR)	✓		
Hibernation mode with internal/external PID controller	✓	–	–
Belt monitoring with and without sensor (load torque monitoring)	✓	–	✓
Dry-running/overload protection monitoring (load torque monitoring)	✓	–	–
Thermal motor protection	✓ ( $I^2t$ , sensor: PTC/Pt1000/KTY/bimetal)		
Thermal converter protection	✓		
Motor identification	✓		
Motor holding brake	–	✓	✓
Auto-ramping ( $V_{dc\_max}$ controller)	✓		
Kinetic buffering ( $V_{dc\_min}$ controller)	✓		
<b>Braking functions for PM240-2</b>			
• DC braking	✓		
• Compound braking	✓		
• Dynamic braking with integrated braking chopper and external braking resistor	✓		
<b>Braking functions for PM250</b> Regenerative feedback	✓		
<b>Mechanical specifications and ambient conditions</b>			
Degree of protection	IP20		
<b>Signal cable cross-section</b>			
• Min.	0.15 mm <sup>2</sup> (AWG28)	0.2 mm <sup>2</sup> (AWG24)	0.2 mm <sup>2</sup> (AWG24)
• Max.	1.5 mm <sup>2</sup> (AWG16)	1.5 mm <sup>2</sup> (AWG16)	1.5 mm <sup>2</sup> (AWG16)
<b>Operating temperature</b> Derating of 3 K/1000 m applies to Control Units as of an installation altitude of 1000 m (3281 ft) above sea level.	-10 ... +60 °C (14 ... 140 °F) For CU230P-2 PN: -10 ... +55 °C (14 ... 131 °F) With IOP-2/BOP-2: 0 ... 50 °C (32 ... 122 °F)	-10 ... +55 °C (14 ... 131 °F) For CU240E-2 PN and CU240E-2 PN-F: -10 ... +53 °C (14 ... 127.4 °F) With IOP-2/BOP-2: 0 ... 50 °C (32 ... 122 °F)	-10 ... +50 °C (14 ... 122 °F) With IOP-2/BOP-2: 0 ... 50 °C (32 ... 122 °F)
<b>Storage temperature</b>	-40 ... +70 °C (-40 ... +158 °F)		
<b>Relative humidity</b>	< 95 % RH, condensation not permissible		
<b>Dimensions</b>			
• Width	73 mm (2.87 in)	73 mm (2.87 in)	73 mm (2.87 in)
• Height	199 mm (7.83 in)	199 mm (7.83 in)	199 mm (7.83 in)
• Depth	65.5 mm (2.58 in)	46 mm (1.81 in)	67 mm (2.64 in)
<b>Weight, approx.</b>	0.61 kg (1.34 lb)	0.49 kg (1.08 lb)	0.67 kg (1.48 lb)

## SINAMICS G120 standard converters

0.37 kW to 250 kW (0.5 hp to 400 hp)

### Power Modules

#### Overview

**PM240-2 Power Modules – 0.55 kW to 250 kW (0.75 hp to 400 hp), IP20 degree of protection**



PM240-2 Power Modules, frame sizes FSA to FSG (with Control Unit and Operator Panel)

The PM240-2 Power Modules are based on a new hardware platform. This permits an increase in power density .

Furthermore, the PM240-2 Power Module is also suitable for use in safety-oriented applications. In conjunction with a fail-safe Control Unit, the drive can be transformed into a Safety Integrated Drive (see section [Control Units](#)).

The PM240-2 Power Modules in frame sizes FSA to FSF are available both with and without an integrated line filter class A of compact design for 200 V, 400 V and 690 V line voltages (except PM240-2 frame sizes FSD to FSF: 200 V). The PM240-2 Power Modules in frame size FSG are available with an integrated line filter Category C3 of compact design for 400 V and 690 V line voltages, also with integrated line filter Category C2 for a line voltage of 400 V. In addition, a DC link reactor is integrated in the PM240-2 Power Modules, frame sizes FSD to FSG, and therefore no line reactor is required.

The PM240-2 Power Modules with integrated line filter class A are suitable for connection to TN supply systems. Power Modules without integrated line filter can be connected to grounded TN/TT systems and non-grounded IT systems.

The PM240-2 Power Module has an integrated braking chopper. In generating mode, the excess energy of the DC link can be dissipated by means of an optional braking resistor.

The permissible cable lengths between converter and motor are limited (for max. permissible cable lengths, see [Integration](#)). Longer cables can be used if output reactors are connected (see section [Load-side power components](#)).

Shield plates and shield connection kits are available for use in the wiring installation of Control Units and Power Modules to ensure that it complies with EMC guidelines.

For more information, see [shield connection kits for Control Units and Power Modules in section Supplementary system components](#).

## Overview

### PM250 Power Modules – 7.5 kW to 90 kW (10 hp to 125 hp), IP20 degree of protection



PM250 Power Modules, frame sizes FSC to FSF

PM250 Power Modules are suitable for a large number of applications in general mechanical engineering. Any braking energy is directly fed back into the line supply (four-quadrant applications – a braking chopper is not required).

The PM250 Power Module features an absolutely unique technology – Efficient Infeed Technology. This feature provides the ability to feed energy back into the supply system in the generator mode (electronic braking) so that the energy is not converted into heat in a braking resistor. This saves space in the control cabinet. The time-consuming process of dimensioning the braking resistor and the expense of the extra wiring are eliminated. Furthermore, heat losses in the control cabinet are reduced.

Further, the innovative circuit design reduces the line harmonics. There is no need to use an optional line reactor at the supply infeed. This saves space and costs for engineering and procurement.

The permissible cable lengths between converter and motor are limited (for max. permissible cable lengths, [see Integration](#)). Longer cables can be used if output reactors are connected ([see section Load-side power components](#)).

Frame sizes FSD to FSF of the PM250 Power Modules are available both with as well as without integrated line filter class A.

For frame size FSC of the PM250 Power Module with an integrated line filter class A, an additional base filter of class B is available for achieving class B ([see section Line-side components](#)).

The PM250 Power Module is also designed for safety-oriented applications. In conjunction with a fail-safe Control Unit, the drive can be transformed into a Safety Integrated Drive ([see section Control Units](#)).

The PM250 Power Modules with integrated line filter class A are suitable for connection to TN supply systems. Power Modules without integrated line filter can be connected to grounded TN/TT systems and non-grounded IT systems.

#### Note:

Shield plates and shield connection kits are available for use in the wiring installation of Control Units and Power Modules to ensure that it complies with EMC guidelines.

For more information, see [shield connection kits for Control Units and Power Modules in section Supplementary system components](#).

## SINAMICS G120 standard converters

0.37 kW to 250 kW (0.5 hp to 400 hp)

### Power Modules

#### Integration

All Power Modules have the following connections and interfaces:

- PM-IF interface to connect the Power Module to the Control Unit. The Power Module also supplies power to the Control Unit using an integrated power supply
- Motor connection using screw terminals or screw studs
- 2 PE/protective conductor connections
- Shield connection plate

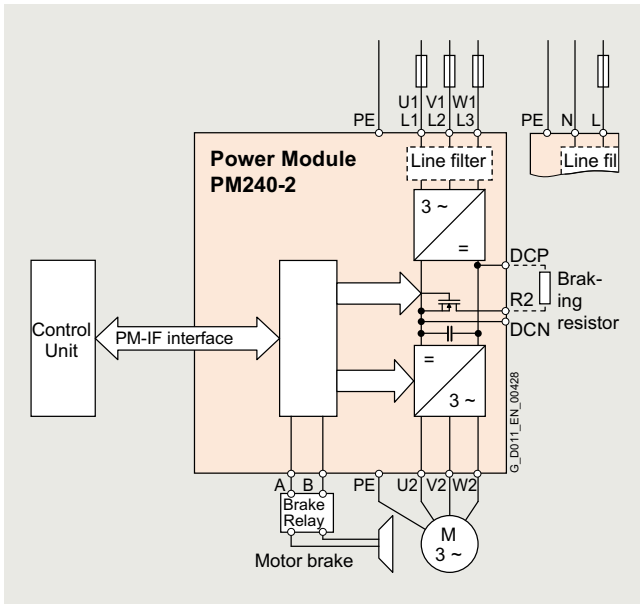

Connection example for PM240-2 Power Modules, frame sizes FSA to FSC, with or without integrated line filter

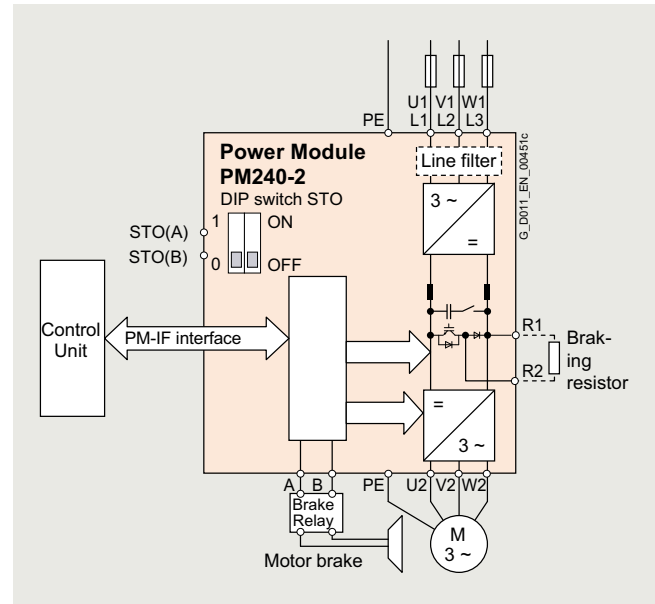

Connection example for PM240-2 Power Modules, frame sizes FSD to FSG, with or without integrated line filter

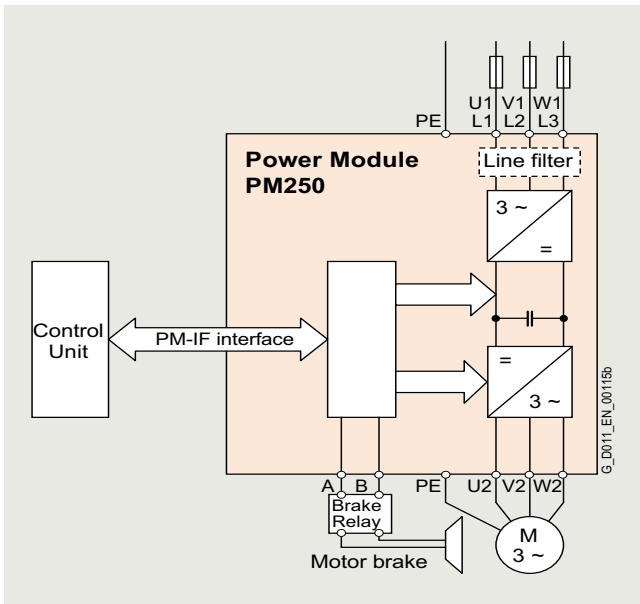

Connection example for PM250 Power Modules with or without integrated line filter



## Integration

### Power and DC link components that are optionally available depending on the Power Module used

The following line-side components, DC link components and load-side power components are optionally available in the appropriate frames sizes for the Power Modules:

	Frame size						
	FSA	FSB	FSC	FSD	FSE	FSF	FSG
<b>PM240-2 Power Module with integrated braking chopper</b>							
• 200 V versions	✓	✓	✓	✓ <sup>1)</sup>	✓ <sup>1)</sup>	✓ <sup>1)</sup>	–
• 400 V versions	✓	✓	✓	✓	✓	✓	✓
• 690 V versions	–	–	–	✓	✓	✓	✓
<b>Line-side components</b>							
Line filter class A	F	F	F	F <sup>1)</sup>	F <sup>1)</sup>	F <sup>1)</sup>	–
Line filter class B (only for 400 V versions)	U	U	U	–	–	–	–
Line filters of Category C2 or C3 (for 400 V versions frame size FSG)	–	–	–	–	–	–	I <sup>2)</sup>
Line filters of Category C3 (for 690 V versions frame size FSG)	–	–	–	–	–	–	I <sup>2)</sup>
Line Harmonics Filters (only for 400 V versions, frame sizes FSD to FSG)	–	–	–	S	S	S	S
Line reactor (only for 3 AC versions <sup>3)</sup> )	S <sup>4)</sup>	S <sup>4)</sup>	S <sup>4)</sup>	I	I	I	I
<b>DC link components</b>							
Braking resistor	S	S	S	S	S	S	S
<b>Load-side power components</b>							
Output reactor	S	S	S	S	S	S	S
Sine-wave filters (only for 400 V versions)	S	S	S	–	–	–	–
dv/dt filters plus VPL (only for 400 V versions)	–	–	–	S	S	S	–
dv/dt filters plus VPL (only for 690 V versions <sup>5)</sup> )	–	–	–	S	S	S	S
<b>PM250 Power Module with line-commutated energy recovery</b>							
• 400 V versions	–	–	✓	✓	✓	✓	–
<b>Line-side components</b>							
Line filter class A	–	–	I	F	F	F	–
Line filter class B	–	–	U	–	–	–	–
Line reactor <sup>6)</sup>	–	–	– <sup>6)</sup>	– <sup>6)</sup>	– <sup>6)</sup>	– <sup>6)</sup>	–
<b>DC link components</b>							
Braking resistor <sup>7)</sup>	–	–	– <sup>7)</sup>	– <sup>7)</sup>	– <sup>7)</sup>	– <sup>7)</sup>	–
<b>Load-side power components</b>							
Output reactor	–	–	U	S	S	S	–
Sine-wave filter	–	–	U	S	S	S	–

U = Base component

S = Lateral mounting

I = Integrated

F = Power Modules available with and without integrated filter class A

– = Not possible

<sup>1)</sup> The 200 V versions of the PM240-2 Power Modules, frame sizes FSD to FSF, are only available without integrated line filter.

<sup>2)</sup> The PM240-2 Power Modules frame size FSG with an integrated Category C3 filter can also be operated on TN systems with a grounded line conductor. To do so, the grounding screw must be removed. Then Category C3 can no longer be adhered to.

<sup>3)</sup> With the appropriate wiring, the line reactors for 200 V 3 AC can be used for the 200 V versions for 200 V 1 AC. More information can be found on the internet at:  
<https://support.industry.siemens.com/cs/document/109486005>  
<https://support.industry.siemens.com/cs/document/109482011>

<sup>4)</sup> For frame sizes FSA to FSC, for lines with  $u_k < 1\%$ , it is recommended that you use a line reactor or the next more powerful Power Module. More information can be found on the internet at:  
<https://support.industry.siemens.com/cs/document/109482011>

<sup>5)</sup> The 690 V versions of the PM240?2 Power Modules require motors with a suitable isolating system for 690 V converter operation (IVIC?C premium). The VSD10 line with corresponding SIMOTICS GP 1LE109 General Purpose motors or SIMOTICS SD 1LE159 Severe Duty motors is ideally suited for converter operation at 690 V. Additional information is available in Catalog D 81.1.

<sup>6)</sup> A line reactor is not required and must not be used in conjunction with a PM250 Power Module.

## SINAMICS G120 standard converters

0.37 kW to 250 kW (0.5 hp to 400 hp)

### Power Modules

#### Integration

##### General design information

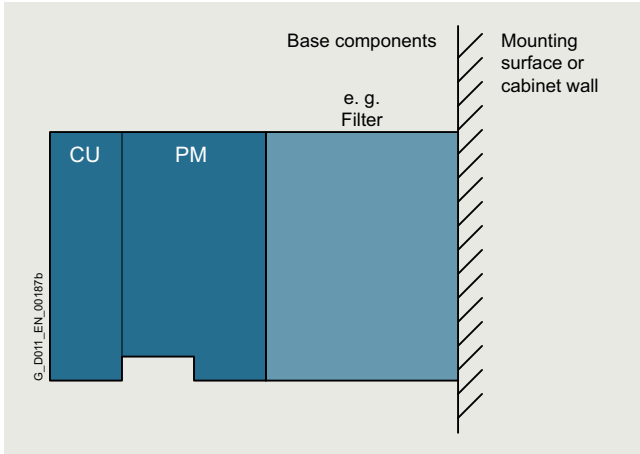

Converter comprising a Power Module (PM), a Control Unit (CU), and base components (side view)

- If at all possible, the line filter should be mounted directly below the converter <sup>1)</sup>.
- With lateral mounting, the line-side components have to be mounted on the left side of the converter, and the load-side components on the right side.
- Braking resistors have to be mounted directly on the control cabinet wall due to heating issues.

##### Recommended installation combinations of the converter and optional power and DC link components

Power Module Frame size	Base	Lateral mounting <b>Left of the converter (for line-side components)</b>	<b>Right of the converter (for load-side power components and DC link components)</b>
FSA and FSB	Line filters, sine-wave filters	Line reactor	Output reactor and/or braking resistor
FSC	Line filters <sup>1)</sup> , sine-wave filters	Line reactor	Output reactor and/or braking resistor
FSD and FSE	–	Line filters, Line Harmonics Filters	Output reactor or sine-wave filter or dv/dt filter plus VPL and/or braking resistor
FSF and FSG	–	Line filters, Line Harmonics Filters	Output reactor or sine-wave filter or dv/dt filter plus VPL and/or braking resistor

<sup>1)</sup> With the PM250 Power Module, frame size FSC, the output reactor and sine-wave filter can be installed as base components. The output reactor or sine-wave filter should be mounted under the line filter.

# SINAMICS G120 standard converters

0.37 kW to 250 kW (0.5 hp to 400 hp)

Power Modules

## Integration

**Maximum permissible cable lengths from the motor to the converter when using output reactors, sine-wave filters, dv/dt filters plus VPL or filters depending on the voltage range and the Power Module being used**

Frame size	Maximum permissible motor cable lengths (shielded/unshielded) in m (ft)						
	FSA	FSB	FSC	FSD	FSE	FSF	FSG
<b>PM240-2 Power Module with integrated braking chopper</b>							
<b>Without optional power components</b>							
• 200 V versions without integrated line filter	50/100 (164/328)	50/100 (164/328)	50/100 (164/328)	200/300 (656/984)	200/300 (656/984)	300/450 (984/1476)	–
• 200 V versions with integrated line filter	50/100 (164/328)	50/100 (164/328)	50/100 (164/328)	–	–	–	–
• 400 V versions without integrated line filter	150/150 (492/492)	150/150 (492/492)	150/150 (492/492)	200/300 (656/984)	200/300 (656/984)	300/450 (984/1476)	300/450 (984/1476)
• 400 V versions with integrated line filter	50/100 (164/328)	100/100 <sup>1)</sup> (328/328) <sup>1)</sup>	150/150 <sup>1)</sup> (492/492) <sup>1)</sup>	200/300 (656/984)	200/300 (656/984)	300/450 (984/1476)	300/450 (984/1476)
• 690 V versions	–	–	–	200/300 (656/984)	200/300 (656/984)	300/450 (984/1476)	300/450 (984/1476)
<b>With optional output reactor</b>							
• At 200 ... 240 V 1 AC/3 AC	150/225 (492/738)	150/225 (492/738)	150/225 (492/738)	200/300 (656/984) <sup>2)</sup>	200/300 (656/984) <sup>2)</sup>	300/450 (984/1476) <sup>2)</sup>	–
• At 380 ... 415 V 3 AC	150/225 (492/738)	150/225 (492/738)	150/225 (492/738)	200/300 (656/984) <sup>2)</sup>	200/300 (656/984) <sup>2)</sup>	300/450 (984/1476) <sup>2)</sup>	300/450 (984/1476) <sup>2)</sup>
• At 440 ... 480 V 3 AC	100/150 (328/492)	100/150 (328/492)	100/150 (328/492)	200/300 (656/984) <sup>2)</sup>	200/300 (656/984) <sup>2)</sup>	300/450 (984/1476) <sup>2)</sup>	300/450 (984/1476) <sup>2)</sup>
• At 500 ... 690 V 3 AC	–	–	–	350/525 (1148/1723)	350/525 (1148/1723)	525/800 (1723/2625)	525/800 (1723/2625)
<b>With optional sine-wave filter</b>							
• At 380 ... 480 V 3 AC	200/300 (656/984)	200/300 (656/984)	200/300 (656/984)	–	–	–	–
<b>With optional dv/dt filter plus VPL</b>							
• At 380 ... 480 V 3 AC	–	–	–	30 kW: 350/525 (1148/1723)	450/650 (1476/2133) <sup>3)</sup>	450/650 (1476/2133) <sup>3)</sup>	–
• At 500 ... 690 V 3 AC	–	–	–	37 kW: 450/650 (1476/2133) <sup>3)</sup>	350/525 (1148/1723)	450/650 (1476/2133) <sup>3)</sup>	450/650 (1476/2133) <sup>3)</sup>
<b>With integrated line filter</b> According to EN 55011 to comply with radio interference emissions according to EN 61800-3 EMC Category C2							
• At 200 ... 240 V 1 AC/3 AC	50/- (164/-)	50/- (164/-)	50/- (164/-)	–	–	–	–
• At 380 ... 480 V 3 AC	50/- (164/-)	100/- (328/-) <sup>4)</sup>	150/- (492/-) <sup>4)</sup>	150/- (492/-)	150/- (492/-)	150/- (492/-)	150 /- (492/-) (Category C2) 300 /- (984/-) (Category C3 <sup>5)</sup> )
• At 500 ... 690 V 3 AC	–	–	–	100/- (328/-)	100/- (328/-)	150 /- (492/-) (Category C3)	300 /- (984/-) (Category C3 <sup>5)</sup> )
<b>With optional, external line filter class B</b> According to EN 55011 to comply with conducted radio interference emissions according to EN 61800-3 EMC Category C1 <sup>6)</sup> , together with unfiltered Power Module							
• At 380 ... 480 V 3 AC	50/- (164/-)	50/- (164/-)	50/- (164/-)	–	–	–	–
<b>With optional, external line filter class B</b> According to EN 55011 to comply with conducted radio interference emissions according to EN 61800-3 EMC Category C2 <sup>6)</sup> , together with unfiltered Power Module							
• At 380 ... 480 V 3 AC	150/- (492/-) <sup>4)</sup>	100/- (328/-) <sup>4)</sup>	100/- (328/-) <sup>4)</sup>	–	–	–	–
<b>With optional, external line filter class B</b> According to EN 55011 and optional output reactor to comply with radio interference emissions according to EN 61800-3 EMC Category C2 <sup>6)</sup> , together with unfiltered Power Module							
• At 380 ... 415 V 3 AC	150/- (492/-)	150/- (492/-)	150/- (492/-)	–	–	–	–
• At 440 ... 480 V 3 AC	100/- (328/-)	100/- (328/-)	100/- (328/-)	–	–	–	–

Footnotes see page 9/42.

## SINAMICS G120 standard converters

0.37 kW to 250 kW (0.5 hp to 400 hp)

### Power Modules

#### Integration

**Maximum permissible cable lengths from the motor to the converter when using output reactors, sine-wave filters, dv/dt filters plus VPL or filters depending on the voltage range and the Power Module being used** (continued)

Frame size	Maximum permissible motor cable lengths (shielded/unshielded) in m (ft)						
	FSA	FSB	FSC	FSD	FSE	FSF	FSG
<b>PM250 Power Module with line-commutated energy recovery</b>							
<b>Without optional power components</b>	–	–	25/100 (82/328)	50/100 (164/328) <sup>7)</sup>	50/100 (164/328) <sup>7)</sup>	50/100 (164/328) <sup>7)</sup>	–
<b>With optional output reactor</b>							
• At 380 ... 400 V 3 AC	–	–	150/225 (492/738)	200/300 (656/984)	200/300 (656/984)	200/300 (656/984)	–
• At 401 ... 480 V 3 AC	–	–	100/150 (328/492)	200/300 (656/984)	200/300 (656/984)	200/300 (656/984)	–
<b>With optional sine-wave filter</b>							
• At 380 ... 480 V 3 AC	–	–	200/300 (656/984)	200/300 (656/984)	200/300 (656/984)	200/300 (656/984)	–

#### Selection and ordering data

To ensure that a suitable Power Module is selected, the following currents should be used for applications:

- Rated output current for applications with low overload (LO)
- Base-load current for applications with high overload (HO)

With reference to the rated output current, the modules support at least 2-pole to 6-pole low-voltage motors, e.g. the SIMOTICS 1LE1 motor series. The rated power is merely a guide value. For a description of the overload performance, please refer to the general technical specifications of the Power Modules.

#### PM240-2 Power Modules standard variant

Rated power <sup>8)</sup>		Rated output current $I_N$ <sup>9)</sup> A	Power based on the base-load current <sup>10)</sup>		Base-load current $I_H$ <sup>10)</sup> A	Frame size	PM240-2 Power Module standard variant without integrated line filter Article No.	PM240-2 Power Module standard variant with integrated line filter class A Article No.
kW	hp		kW	hp				
<b>200 ... 240 V 1 AC/3 AC</b>								
0.55	0.75	3.2	0.37	0.5	2.3	FSA	6SL3210-1PB13-0UL0	6SL3210-1PB13-0AL0
0.75	1	4.2	0.55	0.75	3.2	FSA	6SL3210-1PB13-8UL0	6SL3210-1PB13-8AL0
1.1	1.5	6	0.75	1	4.2	FSB	6SL3210-1PB15-5UL0	6SL3210-1PB15-5AL0
1.5	2	7.4	1.1	1.5	6	FSB	6SL3210-1PB17-4UL0	6SL3210-1PB17-4AL0
2.2	3	10.4	1.5	2	7.4	FSB	6SL3210-1PB21-0UL0	6SL3210-1PB21-0AL0
3	4	13.6	2.2	3	10.4	FSC	6SL3210-1PB21-4UL0	6SL3210-1PB21-4AL0
4	5	17.5	3	4	13.6	FSC	6SL3210-1PB21-8UL0	6SL3210-1PB21-8AL0
<b>200 ... 240 V 3 AC</b>								
5.5	7.5	22	4	5	17.5	FSC	6SL3210-1PC22-2UL0	6SL3210-1PC22-2AL0
7.5	10	28	5.5	7.5	22	FSC	6SL3210-1PC22-8UL0	6SL3210-1PC22-8AL0
11	15	42	7.5	10	35	FSD	6SL3210-1PC24-2UL0	–
15	20	54	11	15	42	FSD	6SL3210-1PC25-4UL0	–
18.5	25	68	15	20	54	FSD	6SL3210-1PC26-8UL0	–
22	30	80	18.5	25	68	FSE	6SL3210-1PC28-0UL0	–
30	40	104	22	30	80	FSE	6SL3210-1PC31-1UL0	–
37	50	130	30	40	104	FSF	6SL3210-1PC31-3UL0	–
45	60	154	37	50	130	FSF	6SL3210-1PC31-6UL0	–
55	75	178	45	60	154	FSF	6SL3210-1PC31-8UL0	–

<sup>1)</sup> The values apply with low-capacitance CY cables – the max. permissible motor cable length is 50 m (164 ft) (shielded) and 100 m (328 ft) (unshielded) as standard.

<sup>2)</sup> For frame sizes FSD to FSG the maximum permissible cable lengths are not increased with an output reactor. By means of the output reactor, the loading of the motor windings is reduced by lower rates of voltage rise (dv/dt). By means of two output reactors connected in series, the maximum permissible cable lengths for frame sizes FSD and FSE are increased to 350 m (1148 ft) (shielded) and 525 m (1723 ft) (unshielded), and for frame sizes FSF and FSG to 525 m (1723 ft) (shielded) and 800 m (2625 ft) (unshielded).

<sup>3)</sup> Maximum overvoltage at the motor terminals <1350 V with cable lengths up to 450 m (1476 ft) shielded or 650 m (2133 ft) unshielded – maximum overvoltage at the motor terminals <1500 V with cable lengths up to 525 m (1723 ft) shielded or 800 m (2625 ft) unshielded.

<sup>4)</sup> The values apply with low-capacitance CY cables – the max. permissible motor cable length is 50 m (164 ft) (shielded) as standard.

<sup>5)</sup> The 690 V versions of the PM240-2 Power Modules frame size FSG are only available with an integrated Category C3 filter. To operate the converter also within TN systems with grounded outer conductor, you must remove the grounding screw.

<sup>6)</sup> More information is available on the internet at [www.siemens.com/sinamics-g120/documentation](http://www.siemens.com/sinamics-g120/documentation)

<sup>7)</sup> Max. motor cable length 25 m (82 ft) (shielded) for Power Modules with integrated line filter to maintain the limit values acc. to EN 61800-3 Category C2.

<sup>8)</sup> Rated power based on the rated output current  $I_N$ . The rated output current  $I_N$  is based on the duty cycle for low overload (LO).

<sup>9)</sup> The rated output current  $I_N$  is based on the duty cycle for low overload (LO). These current values are valid for 200 V, 400 V or 690 V and are specified on the rating plate of the Power Module.

<sup>10)</sup> The base-load current  $I_H$  is based on the duty cycle for high overload (HO).

# SINAMICS G120 standard converters

0.37 kW to 250 kW (0.5 hp to 400 hp)

Power Modules

## Selection and ordering data

Rated power <sup>1)</sup>		Rated output current $I_N$ <sup>2)</sup> A	Power based on the base-load current <sup>3)</sup>		Base-load current $I_H$ <sup>3)</sup> A	Frame size	PM240-2 Power Module standard variant without integrated line filter	PM240-2 Power Module standard variant with integrated line filter Class A
kW	hp		kW	hp			Article No.	Article No.
<b>380 ... 480 V 3 AC <sup>4)</sup></b>								
0.55	0.75	1.7	0.37	0.5	1.3	FSA	6SL3210-1PE11-8UL1	6SL3210-1PE11-8AL1
0.75	1	2.2	0.55	0.75	1.7	FSA	6SL3210-1PE12-3UL1	6SL3210-1PE12-3AL1
1.1	1.5	3.1	0.75	1	2.2	FSA	6SL3210-1PE13-2UL1	6SL3210-1PE13-2AL1
1.5	2	4.1	1.1	1.5	3.1	FSA	6SL3210-1PE14-3UL1	6SL3210-1PE14-3AL1
2.2	3	5.9	1.5	2	4.1	FSA	6SL3210-1PE16-1UL1	6SL3210-1PE16-1AL1
3	4	7.7	2.2	3	5.9	FSA	6SL3210-1PE18-0UL1	6SL3210-1PE18-0AL1
4	5	10.2	3	4	7.7	FSB	6SL3210-1PE21-1UL0	6SL3210-1PE21-1AL0
5.5	7.5	13.2	4	5	10.2	FSB	6SL3210-1PE21-4UL0	6SL3210-1PE21-4AL0
7.5	10	18	5.5	7.5	13.2	FSB	6SL3210-1PE21-8UL0	6SL3210-1PE21-8AL0
11	15	26	7.5	10	18	FSC	6SL3210-1PE22-7UL0	6SL3210-1PE22-7AL0
15	20	32	11	15	26	FSC	6SL3210-1PE23-3UL0	6SL3210-1PE23-3AL0
18.5	25	38	15	20	32	FSD	6SL3210-1PE23-8UL0	6SL3210-1PE23-8AL0
22	30	45	18.5	25	38	FSD	6SL3210-1PE24-5UL0	6SL3210-1PE24-5AL0
30	40	60	22	30	45	FSD	6SL3210-1PE26-0UL0	6SL3210-1PE26-0AL0
37	50	75	30	40	60	FSD	6SL3210-1PE27-5UL0	6SL3210-1PE27-5AL0
45	60	90	37	50	75	FSE	6SL3210-1PE28-8UL0	6SL3210-1PE28-8AL0
55	75	110	45	60	90	FSE	6SL3210-1PE31-1UL0	6SL3210-1PE31-1AL0
75	100	145	55	75	110	FSF	6SL3210-1PE31-5UL0	6SL3210-1PE31-5AL0
90	125	178	75	100	145	FSF	6SL3210-1PE31-8UL0	6SL3210-1PE31-8AL0
110	150	205	90	125	178	FSF	6SL3210-1PE32-1UL0	6SL3210-1PE32-1AL0
132	200	250	110	150	205	FSF	6SL3210-1PE32-5UL0	6SL3210-1PE32-5AL0
<b>500 ... 690 V 3 AC</b>								
11	10	14	7.5	7.5	11	FSD	6SL3210-1PH21-4UL0	6SL3210-1PH21-4AL0
15	15	19	11	10	14	FSD	6SL3210-1PH22-0UL0	6SL3210-1PH22-0AL0
18.5	20	23	15	15	19	FSD	6SL3210-1PH22-3UL0	6SL3210-1PH22-3AL0
22	25	27	18.5	20	23	FSD	6SL3210-1PH22-7UL0	6SL3210-1PH22-7AL0
30	30	35	22	25	27	FSD	6SL3210-1PH23-5UL0	6SL3210-1PH23-5AL0
37	40	42	30	30	35	FSD	6SL3210-1PH24-2UL0	6SL3210-1PH24-2AL0
45	50	52	37	40	42	FSE	6SL3210-1PH25-2UL0	6SL3210-1PH25-2AL0
55	60	62	45	50	52	FSE	6SL3210-1PH26-2UL0	6SL3210-1PH26-2AL0
75	75	80	55	60	62	FSF	6SL3210-1PH28-0UL0	6SL3210-1PH28-0AL0
90	100	100	75	75	80	FSF	6SL3210-1PH31-0UL0	6SL3210-1PH31-0AL0
110	100	115	90	100	100	FSF	6SL3210-1PH31-2UL0	6SL3210-1PH31-2AL0
132	125	142	110	100	115	FSF	6SL3210-1PH31-4UL0	6SL3210-1PH31-4AL0
<b>380 ... 480 V 3 AC <sup>4)</sup></b>								
160	250	302	132	200	250	FSG	6SL3210-1PE33-0CL0	6SL3210-1PE33-0AL0
200	300	370	160	250	302	FSG	6SL3210-1PE33-7CL0	6SL3210-1PE33-7AL0
250	400	477	200	300	370	FSG	6SL3210-1PE34-8CL0	6SL3210-1PE34-8AL0
<b>500 ... 690 V 3 AC</b>								
160	150	171	132	150	142	FSG <sup>5)</sup>	6SL3210-1PH31-7CL0	–
200	200	208	160	150	171	FSG <sup>5)</sup>	6SL3210-1PH32-1CL0	–
250	250	250	200	200	208	FSG <sup>5)</sup>	6SL3210-1PH32-5CL0	–

- 1) Rated power based on the rated output current  $I_N$ . The rated output current  $I_N$  is based on the duty cycle for low overload (LO).
- 2) The rated output current  $I_N$  is based on the duty cycle for low overload (LO). These current values are valid for 200 V, 400 V or 690 V and are specified on the rating plate of the Power Module.
- 3) The base-load current  $I_H$  is based on the duty cycle for high overload (HO).

- 4) SIPLUS components for extreme requirements are available. More information is available on the internet at [www.siemens.com/siplus-drives](http://www.siemens.com/siplus-drives)
- 5) The 690 V versions of the PM240-2 Power Modules frame size FSG are only available with an integrated Category C3 filter. To operate the converter also within TN systems with grounded outer conductor, you must remove the grounding screw. If the grounding screw is removed, the EMC property according to Category C3 is no longer given.

**SINAMICS G120 standard converters**

0.37 kW to 250 kW (0.5 hp to 400 hp)

**Power Modules****Selection and ordering data****PM250 Power Modules**

Rated power <sup>1)</sup>		Rated output current $I_N$ <sup>2)</sup> A	Power based on the base-load current <sup>3)</sup>		Base-load current $I_H$ <sup>3)</sup> A	Frame size	PM250 Power Module without integrated line filter	PM250 Power Module with integrated line filter class <b>A</b>
kW	hp		kW	hp			Article No.	Article No.
<b>380 ... 480 V 3 AC</b>								
<b>7.5</b>	10	18	<b>5.5</b>	7.5	13.2	FSC	–	<b>6SL3225-0BE25-5AA1</b>
<b>11</b>	15	25	<b>7.5</b>	10	19	FSC	–	<b>6SL3225-0BE27-5AA1</b>
<b>15</b>	20	32	<b>11</b>	15	26	FSC	–	<b>6SL3225-0BE31-1AA1</b>
<b>18.5</b>	25	38	<b>15</b>	20	32	FSD	<b>6SL3225-0BE31-5UA0</b>	<b>6SL3225-0BE31-5AA0</b>
<b>22</b>	30	45	<b>18.5</b>	25	38	FSD	<b>6SL3225-0BE31-8UA0</b>	<b>6SL3225-0BE31-8AA0</b>
<b>30</b>	40	60	<b>22</b>	30	45	FSD	<b>6SL3225-0BE32-2UA0</b>	<b>6SL3225-0BE32-2AA0</b>
<b>37</b>	50	75	<b>30</b>	40	60	FSE	<b>6SL3225-0BE33-0UA0</b>	<b>6SL3225-0BE33-0AA0</b>
<b>45</b>	60	90	<b>37</b>	50	75	FSE	<b>6SL3225-0BE33-7UA0</b>	<b>6SL3225-0BE33-7AA0</b>
<b>55</b>	75	110	<b>45</b>	60	90	FSF	<b>6SL3225-0BE34-5UA0</b>	<b>6SL3225-0BE34-5AA0</b>
<b>75</b>	100	145	<b>55</b>	75	110	FSF	<b>6SL3225-0BE35-5UA0</b>	<b>6SL3225-0BE35-5AA0</b>
<b>90</b>	125	178	<b>75</b>	100	145	FSF	<b>6SL3225-0BE37-5UA0</b>	<b>6SL3225-0BE37-5AA0</b>

<sup>1)</sup> Rated power based on the rated output current  $I_N$ . The rated output current  $I_N$  is based on the duty cycle for low overload (LO).

<sup>2)</sup> The rated output current  $I_N$  is based on the duty cycle for low overload (LO). These current values are valid for 400 V and are specified on the rating plate of the Power Module.

<sup>3)</sup> The base-load current  $I_H$  is based on the duty cycle for high overload (HO).

## Technical specifications

### General technical specifications

Power Modules	PM240-2	PM250
<b>System operating voltage</b>	FSA ... FSC: 200 ... 240 V 1 AC/3 AC ±10 % 380 ... 480 V 3 AC ±10 % FSD ... FSG: 200 ... 240 V 3 AC ±10 % (in operation -20 % < 1 min) 380 ... 480 V 3 AC ±10 % (in operation -20 % < 1 min) 500 ... 690 V 3 AC ±10 % (in operation -20 % < 1 min)	380 ... 480 V 3 AC ±10 %
<b>Line supply requirements</b> <b>Short-circuit power ratio <math>R_{SC}</math></b>	200 V: >25 With $R_{SC} > 50$ it is advisable for FSA to FSC to install a line reactor, or alternatively, to select a Power Module with the next-higher power rating. 400 V: >25 With $R_{SC} > 100$ it is advisable for FSA to FSC to install a line reactor, or alternatively, to select a Power Module with the next-higher power rating. 690 V: No restriction	>100
<b>Input frequency</b>	47 ... 63 Hz	
<b>Output frequency</b>		
• Control mode V/f	0 ... 550 Hz	
• Control mode Vector	0 ... 240 Hz	
<b>Pulse frequency</b>	200 V: 4 kHz 400 V: ≤90 kW: 4 kHz; >90 kW: 2 kHz 690 V: 2 kHz For higher pulse frequencies, <a href="#">see derating data</a>	4 kHz For higher pulse frequencies, <a href="#">see derating data</a>
<b>Power factor <math>\lambda</math></b>	FSA ... FSC: 0.7 ... 0.85 FSD ... FSG: - 200 V: >0.95 - 400 V and 690 V: >0.9	0.9
<b>Offset factor <math>\cos \varphi</math></b>	FSA ... FSC: >0.96 FSD ... FSG: 0.98 ... 0.99	0.95 capacitive
<b>Converter efficiency</b> According to IEC 61800-9-2	200 V: >96.2 ... 97.1 % 400 V: >96.0 ... 98.0 % 690 V: >97.3 ... 98.2 %	96.5 ... 97.6 % <sup>1)</sup>
<b>Efficiency class</b> According to IEC 61800-9-2	IE2	IE2 <sup>1)</sup>
<b>Output voltage, max.</b> as % of input voltage	95 %	87 %
<b>Overload capability</b>		
• Low overload (LO) <u>Note:</u> No reduction in base-load current $I_L$ for use of overload.	1.5 × base-load current $I_L$ (i.e. 150 % overload) for 3 s <b>plus</b> 1.1 × base-load current $I_L$ (i.e. 110 % overload) for 57 s within a cycle time of 300 s	1.5 × base-load current $I_L$ (i.e. 150 % overload) for 3 s <b>plus</b> 1.1 × base-load current $I_L$ (i.e. 110 % overload) for 57 s within a cycle time of 300 s
• High overload (HO) <u>Note:</u> No reduction in base-load current $I_H$ for use of overload.	2 × base-load current $I_H$ (i.e. 200 % overload) for 3 s <b>plus</b> 1.5 × base-load current $I_H$ (i.e. 150 % overload) for 57 s within a cycle time of 300 s	2 × base-load current $I_H$ (i.e. 200 % overload) for 3 s <b>plus</b> 1.5 × base-load current $I_H$ (i.e. 150 % overload) for 57 s within a cycle time of 300 s

## SINAMICS G120 standard converters

0.37 kW to 250 kW (0.5 hp to 400 hp)

### Power Modules

#### Technical specifications

Power Modules	PM240-2	PM250
<b>Possible braking methods</b>	DC braking Compound braking Dynamic braking with integrated braking chopper	Energy recovery in generator operation (max. with rated power based on high overload (HO))
<b>Degree of protection</b>	IP20 (standard)	IP20
<b>Operating temperature</b>		
• Low overload (LO)	Frame sizes FSA ... FSC: -10 ... +40 °C (14 ... 104 °F) without derating >40 ... 60 °C (>104 ... 140 °F) <a href="#">see derating characteristics</a>	0 ... 40 °C (32 ... 104 °F) without derating >40 ... 60 °C (>104 ... 140 °F) <a href="#">see derating characteristics</a>
• High overload (HO)	Frame sizes FSD ... FSG: -20 ... +40 °C (-4 ... +104 °F) without derating >40 ... 60 °C (>104 ... 140 °F) <a href="#">see derating characteristics</a>	0 ... 50 °C (32 ... 122 °F) without derating >50 ... 60 °C (>122 ... 140 °F) <a href="#">see derating characteristics</a>
<b>Relative humidity</b>	< 95 % RH, condensation not permissible	
<b>Cooling</b>	Internal air cooling, power units with increased air cooling by built-in fans	Internal air cooling, power units with increased air cooling by built-in fans
<b>Installation altitude</b>	Up to 1000 m (3281 ft) above sea level without derating, > 1000 m (3281 ft) <a href="#">see derating characteristics</a>	Up to 1000 m (3281 ft) above sea level without derating, > 1000 m (3281 ft) <a href="#">see derating characteristics</a>
<b>Protection functions</b>	<ul style="list-style-type: none"> <li>• Undervoltage</li> <li>• Overvoltage</li> <li>• Overload</li> <li>• Ground fault</li> <li>• Short-circuit</li> <li>• Stall protection</li> <li>• Motor blocking protection</li> <li>• Motor overtemperature</li> <li>• Converter overtemperature</li> <li>• Parameter locking</li> </ul>	
<b>Short-Circuit Current Rating SCCR</b> according to UL ( <a href="#">Short-Circuit Current Rating</a> ) <sup>1)</sup>	200 V: 100 kA 400 V: 100 kA 690 V: 100 kA	FSC: 40 kA FSD ... FSF: 42 kA
<b>Compliance with standards</b>	CE, UKCA, cULus, RCM, SEMI F47, RoHS, EAC KC (only with internal or external line filters Category C2) For frame size FSD ... FSG also: WEEE (Waste Electrical & Electronic Equipment)	CE, UKCA, UL, cUL, RCM, SEMI F47, RoHS, EAC KC (only with internal or external line filters Category C2)
<b>CE marking, according to</b>	Low-Voltage Directive 2014/35/EU Ecodesign requirements of the EU Directive 2019/1781 <sup>2)</sup> EMC Directive 2014/30/EU	

<sup>1)</sup> Applies to industrial control panel installations to NEC Article 409 or UL 508A.

<sup>2)</sup> The SINAMICS G120 frequency converters fall under the eco-design requirements of the EU Directive 2019/1781; however, the SINAMICS G120 frequency converters with PM250 Power Modules are considered to be frequency converters with regenerative feedback functionality. Therefore, no efficiency requirements apply in this case.



## Technical specifications

### PM240-2 Power Modules standard variant

Line voltage 200 ... 240 V 1 AC/3 AC		PM240-2 Power Modules standard variant				
Without integrated line filter		6SL3210-1PB13-0UULO	6SL3210-1PB13-8UULO	6SL3210-1PB15-5UULO	6SL3210-1PB17-4UULO	6SL3210-1PB21-0UULO
With integrated line filter class A		6SL3210-1PB13-0AL0	6SL3210-1PB13-8AL0	6SL3210-1PB15-5AL0	6SL3210-1PB17-4AL0	6SL3210-1PB21-0AL0
<b>Output current</b> at 50 Hz 230 V 1 AC						
• Rated current $I_N^{1)}$	A	3.2	4.2	6	7.4	10.4
• Base-load current $I_L^{1)}$	A	3.2	4.2	6	7.4	10.4
• Base-load current $I_H^{2)}$	A	2.3	3.2	4.2	6	7.4
• Maximum current $I_{max}$	A	4.6	6	8.3	11.1	15.6
<b>Rated power</b>						
• Based on $I_L$	kW (hp)	0.55 (0.75)	0.75 (1)	1.1 (1.5)	1.5 (2)	2.2 (3)
• Based on $I_H$	kW (hp)	0.37 (0.50)	0.55 (0.75)	0.75 (1)	1.1 (1.5)	1.5 (2)
<b>Rated pulse frequency</b>						
	kHz	4	4	4	4	4
<b>Efficiency <math>\eta</math></b> According to IEC 61800-9-2						
	%	>96.2	>96.4	>96.7	>96.4	>96.3
<b>Power loss <sup>3)</sup></b> According to IEC 61800-9-2 At rated current						
	kW	0.037	0.046	0.061	0.082	0.118
<b>Cooling air requirement</b>						
	m <sup>3</sup> /s (ft <sup>3</sup> /s)	0.005 (0.18)	0.005 (0.18)	0.0092 (0.325)	0.0092 (0.325)	0.0092 (0.325)
<b>Sound pressure level</b> $L_{pA}$ (1 m)						
	dB	<50	<50	<62	<62	<62
<b>Input current <sup>4)</sup></b>						
• Rated input current 1 AC/3 AC	A	7.5/4.2	9.6/5.5	13.5/7.8	18.1/9.7	24/13.6
• Based on $I_H$ 1 AC/3 AC	A	6.6/3	8.4/4.2	11.8/5.5	15.8/7.8	20.9/9.7
<b>Line supply connection</b> U1/L1, V1/L2, W1/L3						
• Conductor cross-section	mm <sup>2</sup>	1.5 ... 2.5	1.5 ... 2.5	1.5 ... 6	1.5 ... 6	1.5 ... 6
<b>Motor connection</b> U2, V2, W2						
• Conductor cross-section	mm <sup>2</sup>	1.5 ... 2.5	1.5 ... 2.5	1.5 ... 6	1.5 ... 6	1.5 ... 6
<b>PE connection</b>						
		Included in terminal connector	Included in terminal connector	Included in terminal connector	Included in terminal connector	Included in terminal connector
<b>Motor cable length, max.</b>						
• Shielded	m (ft)	50 (164)	50 (164)	50 (164)	50 (164)	50 (164)
• Unshielded	m (ft)	100 (328)	100 (328)	100 (328)	100 (328)	100 (328)
<b>Degree of protection</b>						
		IP20	IP20	IP20	IP20	IP20
<b>Dimensions</b>						
• Width	mm (in)	73 (2.87)	73 (2.87)	100 (3.94)	100 (3.94)	100 (3.94)
• Height	mm (in)	196 (7.72)	196 (7.72)	292 (11.5)	292 (11.5)	292 (11.5)
• Depth						
- Without operator panel	mm (in)	165 (6.50)	165 (6.50)	165 (6.50)	165 (6.50)	165 (6.50)
- With operator panel, max.	mm (in)	238 (9.37)	238 (9.37)	238 (9.37)	238 (9.37)	238 (9.37)
<b>Frame size</b>						
		FSA	FSA	FSB	FSB	FSB
<b>Weight, approx.</b>						
• Without integrated line filter	kg (lb)	1.4 (3.09)	1.4 (3.09)	2.8 (6.17)	2.8 (6.17)	2.8 (6.17)
• With integrated line filter	kg (lb)	1.6 (3.53)	1.6 (3.53)	3.1 (6.84)	3.1 (6.84)	3.1 (6.84)

<sup>1)</sup> The rated output current  $I_N$  and the base-load current  $I_L$  are based on the duty cycle for low overload (LO).

<sup>2)</sup> The base-load current  $I_H$  is based on the duty cycle for high overload (HO).

<sup>3)</sup> Typical values. You can find more information on the internet at: <https://support.industry.siemens.com/cs/document/94059311>

<sup>4)</sup> The input current depends on the motor load and line impedance. The input currents apply for a load at rated power (based on  $I_N$ ) for a line impedance corresponding to  $u_K = 1\%$ . The current values are specified on the rating plate of the Power Module.

## SINAMICS G120 standard converters

0.37 kW to 250 kW (0.5 hp to 400 hp)

### Power Modules

#### Technical specifications

Line voltage 200 ... 240 V 1 AC/3 AC		PM240-2 Power Modules standard variant	
Without integrated line filter		6SL3210-1PB21-4UL0	6SL3210-1PB21-8UL0
With integrated line filter class A		6SL3210-1PB21-4AL0	6SL3210-1PB21-8AL0
<b>Output current</b> at 50 Hz 230 V 1 AC			
• Rated current $I_N^{1)}$	A	13.6	17.5
• Base-load current $I_L^{1)}$	A	13.6	17.5
• Base-load current $I_H^{2)}$	A	10.4	13.6
• Maximum current $I_{max}$	A	20.8	27.2
<b>Rated power</b>			
• Based on $I_L$	kW (hp)	3 (4)	4 (5)
• Based on $I_H$	kW (hp)	2.2 (3)	3 (4)
<b>Rated pulse frequency</b>		kHz	4
<b>Efficiency <math>\eta</math></b> According to IEC 61800-9-2		%	>96.7
<b>Power loss <sup>3)</sup></b> According to IEC 61800-9-2 At rated current		kW	0.137
<b>Cooling air requirement</b>		$m^3/s$ ( $ft^3/s$ )	0.0185 (0.65)
<b>Sound pressure level</b> $L_{pA}$ (1 m)		dB	<65
<b>Input current <sup>4)</sup></b>			
• Rated input current 1 AC/3 AC	A	35.9/17.7	43/22.8
• Based on $I_H$ 1 AC/3 AC	A	31.3/13.6	37.5/17.7
<b>Line supply connection</b> U1/L1, V1/L2, W1/L3		Terminal connector	Terminal connector
• Conductor cross-section	mm <sup>2</sup>	6 ... 16	6 ... 16
<b>Motor connection</b> U2, V2, W2		Terminal connector	Terminal connector
• Conductor cross-section	mm <sup>2</sup>	6 ... 16	6 ... 16
<b>PE connection</b>		Included in terminal connector	Included in terminal connector
<b>Motor cable length, max.</b>			
• Shielded	m (ft)	50 (164)	50 (164)
• Unshielded	m (ft)	100 (328)	100 (328)
<b>Degree of protection</b>		IP20	IP20
<b>Dimensions</b>			
• Width	mm (in)	140 (5.51)	140 (5.51)
• Height	mm (in)	355 (13.98)	355 (13.98)
• Depth			
- Without operator panel	mm (in)	165 (6.50)	165 (6.50)
- With operator panel, max.	mm (in)	238 (9.37)	238 (9.37)
<b>Frame size</b>		FSC	FSC
<b>Weight, approx.</b>			
• Without integrated line filter	kg (lb)	5 (11)	5 (11)
• With integrated line filter	kg (lb)	5.2 (11.5)	5.2 (11.5)

<sup>1)</sup> The rated output current  $I_N$  and the base-load current  $I_L$  are based on the duty cycle for low overload (LO).

<sup>2)</sup> The base-load current  $I_H$  is based on the duty cycle for high overload (HO).

<sup>3)</sup> Typical values. You can find more information on the internet at: <https://support.industry.siemens.com/cs/document/94059311>

<sup>4)</sup> The input current depends on the motor load and line impedance. The input currents apply for a load at rated power (based on  $I_N$ ) for a line impedance corresponding to  $u_K = 1\%$ . The current values are specified on the rating plate of the Power Module.

# SINAMICS G120 standard converters

0.37 kW to 250 kW (0.5 hp to 400 hp)

## Power Modules

### Technical specifications

Line voltage 200 ... 240 V 3 AC		PM240-2 Power Modules standard variant				
		6SL3210-1PC22-2UL0	6SL3210-1PC22-8UL0	6SL3210-1PC24-2UL0	6SL3210-1PC25-4UL0	6SL3210-1PC26-8UL0
Without integrated line filter						
With integrated line filter class A		6SL3210-1PC22-2AL0	6SL3210-1PC22-8AL0	–	–	–
<b>Output current</b> at 50 Hz 230 V 3 AC						
• Rated current $I_N^{1)}$	A	22	28	42	54	68
• Base-load current $I_L^{1)}$	A	22	28	42	54	68
• Base-load current $I_H^{2)}$	A	17.5	22	35	42	54
• Maximum current $I_{max}$	A	35	44	70	84	108
<b>Rated power</b>						
• Based on $I_L$	kW (hp)	5.5 (7.5)	7.5 (10)	11 (15)	15 (20)	18.5 (25)
• Based on $I_H$	kW (hp)	4 (5)	5.5 (7.5)	7.5 (10)	11 (15)	15 (20)
<b>Rated pulse frequency</b>						
	kHz	4	4	4	4	4
<b>Efficiency <math>\eta</math></b> According to IEC 61800-9-2						
	%	>97.0	>96.9	>96.7	>96.5	>96.3
<b>Power loss <sup>3)</sup></b> According to IEC 61800-9-2 At rated current						
	kW	0.217	0.282	0.463	0.626	0.843
<b>Cooling air requirement</b>						
	m <sup>3</sup> /s (ft <sup>3</sup> /s)	0.0185 (0.65)	0.0185 (0.65)	0.055 (1.94)	0.055 (1.94)	0.055 (1.94)
<b>Sound pressure level</b> $L_{pA}$ (1 m)						
	dB	<65	<65	45 ... 65 <sup>4)</sup>	45 ... 65 <sup>4)</sup>	45 ... 65 <sup>4)</sup>
<b>Input current <sup>5)</sup></b>						
• Rated input current	A	28.6	36.4	40	51	64
• Based on $I_H$	A	22.8	28.6	36	43	56
<b>Line supply connection</b> U1/L1, V1/L2, W1/L3						
• Conductor cross-section	mm <sup>2</sup>	6 ... 16	6 ... 16	10 ... 35	10 ... 35	10 ... 35
<b>Motor connection</b> U2, V2, W2						
• Conductor cross-section	mm <sup>2</sup>	6 ... 16	6 ... 16	10 ... 35	10 ... 35	10 ... 35
<b>PE connection</b>						
		Included in terminal connector	Included in terminal connector	Screw terminals	Screw terminals	Screw terminals
<b>Motor cable length, max.</b>						
• Shielded	m (ft)	50 (164)	50 (164)	200 (656)	200 (656)	200 (656)
• Unshielded	m (ft)	100 (328)	100 (328)	300 (984)	300 (984)	300 (984)
<b>Degree of protection</b>						
		IP20	IP20	IP20	IP20	IP20
<b>Dimensions</b>						
• Width	mm (in)	140 (5.51)	140 (5.51)	200 (7.87)	200 (7.87)	200 (7.87)
• Height	mm (in)	355 (13.98)	355 (13.98)	472 (18.58)	472 (18.58)	472 (18.58)
• Depth						
- Without operator panel	mm (in)	165 (6.50)	165 (6.50)	237 (9.33)	237 (9.33)	237 (9.33)
- With operator panel, max.	mm (in)	238 (9.37)	238 (9.37)	268 (10.55)	268 (10.55)	268 (10.55)
<b>Frame size</b>						
		FSC	FSC	FSD	FSD	FSD
<b>Weight, approx.</b>						
• Without integrated line filter	kg (lb)	5 (11)	5 (11)	17 (37.5)	17 (37.5)	17 (37.5)
• With integrated line filter	kg (lb)	5.2 (11.5)	5.2 (11.5)	–	–	–

<sup>1)</sup> The rated output current  $I_N$  and the base-load current  $I_L$  are based on the duty cycle for low overload (LO).

<sup>2)</sup> The base-load current  $I_H$  is based on the duty cycle for high overload (HO).

<sup>3)</sup> Typical values. You can find more information on the internet at: <https://support.industry.siemens.com/cs/document/94059311>

<sup>4)</sup> Values dependent on ambient temperature and utilization.

<sup>5)</sup> The input current depends on the motor load and line impedance. The input currents apply for a load at rated power (based on  $I_N$ ) for a line impedance corresponding to  $u_K = 1\%$ . The current values are specified on the rating plate of the Power Module.

# SINAMICS G120 standard converters

0.37 kW to 250 kW (0.5 hp to 400 hp)

## Power Modules

### Technical specifications

Line voltage 200 ... 240 V 3 AC		PM240-2 Power Modules standard variant				
		6SL3210-1PC28-0U00	6SL3210-1PC31-1U00	6SL3210-1PC31-3U00	6SL3210-1PC31-6U00	6SL3210-1PC31-8U00
Without integrated line filter						
With integrated line filter class A		–	–	–	–	–
<b>Output current</b>						
at 50 Hz 230 V 3 AC						
• Rated current $I_N^{1)}$	A	80	104	130	154	178
• Base-load current $I_L^{1)}$	A	80	104	130	154	178
• Base-load current $I_H^{2)}$	A	68	80	104	130	154
• Maximum current $I_{max}$	A	136	160	208	260	308
<b>Rated power</b>						
• Based on $I_L$	kW (hp)	22 (30)	30 (40)	37 (50)	45 (60)	55 (75)
• Based on $I_H$	kW (hp)	18.5 (25)	22 (30)	30 (40)	37 (50)	45 (60)
<b>Rated pulse frequency</b>	kHz	4	4	4	4	4
<b>Efficiency <math>\eta</math></b>	%	>96.5	>96.2	>96.7	>96.5	>96.4
According to IEC 61800-9-2						
<b>Power loss <sup>3)</sup></b>	kW	0.937	1.31	1.45	1.81	2.20
According to IEC 61800-9-2 At rated current						
<b>Cooling air requirement</b>	m <sup>3</sup> /s (ft <sup>3</sup> /s)	0.083 (2.93)	0.083 (2.93)	0.153 (5.40)	0.153 (5.40)	0.153 (5.40)
<b>Sound pressure level</b>	dB	44 ... 62 <sup>4)</sup>	44 ... 62 <sup>4)</sup>	56 ... 68 <sup>4)</sup>	56 ... 68 <sup>4)</sup>	56 ... 68 <sup>4)</sup>
$L_{pA}$ (1 m)						
<b>Input current <sup>5)</sup></b>						
• Rated input current	A	76	98	126	149	172
• Based on $I_H$	A	71	83	110	138	164
<b>Line supply connection</b>						
U1/L1, V1/L2, W1/L3						
• Conductor cross-section	mm <sup>2</sup>	25 ... 70	25 ... 70	35 ... 2 × 120	35 ... 2 × 120	35 ... 2 × 120
<b>Motor connection</b>						
U2, V2, W2						
• Conductor cross-section	mm <sup>2</sup>	25 ... 70	25 ... 70	35 ... 2 × 120	35 ... 2 × 120	35 ... 2 × 120
<b>PE connection</b>						
Screw terminals						
<b>Motor cable length, max.</b>						
• Shielded	m (ft)	200 (656)	200 (656)	300 (984)	300 (984)	300 (984)
• Unshielded	m (ft)	300 (984)	300 (984)	450 (1476)	450 (1476)	450 (1476)
<b>Degree of protection</b>						
IP20						
<b>Dimensions</b>						
• Width	mm (in)	275 (10.83)	275 (10.83)	305 (12.01)	305 (12.01)	305 (12.01)
• Height	mm (in)	551 (21.69)	551 (21.69)	708 (27.87)	708 (27.87)	708 (27.87)
• Depth						
- Without operator panel	mm (in)	237 (9.33)	237 (9.33)	357 (14.06)	357 (14.06)	357 (14.06)
- With operator panel, max.	mm (in)	268 (10.55)	268 (10.55)	388 (15.28)	388 (15.28)	388 (15.28)
<b>Frame size</b>						
FSE						
<b>Weight, approx.</b>						
• Without integrated line filter	kg (lb)	26 (57.3)	26 (57.3)	57 (126)	57 (126)	57 (126)
• With integrated line filter	kg (lb)	–	–	–	–	–

<sup>1)</sup> The rated output current  $I_N$  and the base-load current  $I_L$  are based on the duty cycle for low overload (LO).

<sup>2)</sup> The base-load current  $I_H$  is based on the duty cycle for high overload (HO).

<sup>3)</sup> Typical values. You can find more information on the internet at: <https://support.industry.siemens.com/cs/document/94059311>

<sup>4)</sup> Values dependent on ambient temperature and utilization.

<sup>5)</sup> The input current depends on the motor load and line impedance. The input currents apply for a load at rated power (based on  $I_N$ ) for a line impedance corresponding to  $u_K = 1\%$ . The current values are specified on the rating plate of the Power Module.

## Technical specifications

Line voltage 380 ... 480 V 3 AC		PM240-2 Power Modules standard variant					
		6SL3210-1PE11-8UL1	6SL3210-1PE12-3UL1	6SL3210-1PE13-2UL1	6SL3210-1PE14-3UL1	6SL3210-1PE16-1UL1	6SL3210-1PE18-0UL1
Without integrated line filter							
With integrated line filter class A		6SL3210-1PE11-8AL1	6SL3210-1PE12-3AL1	6SL3210-1PE13-2AL1	6SL3210-1PE14-3AL1	6SL3210-1PE16-1AL1	6SL3210-1PE18-0AL1
<b>Output current</b> at 50 Hz 400 V 3 AC							
• Rated current $I_N^{1)}$	A	1.7	2.2	3.1	4.1	5.9	7.7
• Base-load current $I_L^{1)}$	A	1.7	2.2	3.1	4.1	5.9	7.7
• Base-load current $I_H^{2)}$	A	1.3	1.7	2.2	3.1	4.1	5.9
• Maximum current $I_{max}$	A	2.6	3.4	4.7	6.2	8.9	11.8
<b>Rated power</b>							
• Based on $I_L$	kW (hp)	0.55 (0.75)	0.75 (1)	1.1 (1.5)	1.5 (2)	2.2 (3)	3 (4)
• Based on $I_H$	kW (hp)	0.37 (0.50)	0.55 (0.75)	0.75 (1)	1.1 (1.5)	1.5 (2)	2.2 (3)
<b>Rated pulse frequency</b>		kHz	4	4	4	4	4
<b>Efficiency <math>\eta</math></b> According to IEC 61800-9-2		%	>96.0	>96.7	>97.1	>97.3	>97.3
<b>Power loss <sup>3)</sup></b> According to IEC 61800-9-2 At rated current		kW	0.032	0.037	0.047	0.057	0.080
<b>Cooling air requirement</b>		$m^3/s$ ( $ft^3/s$ )	0.005 (0.18)	0.005 (0.18)	0.005 (0.18)	0.005 (0.18)	0.005 (0.18)
<b>Sound pressure level</b> $L_{pA}$ (1 m)		dB	<50	<50	<50	<57	<57
<b>Input current <sup>4)</sup></b>							
• Rated input current	A	2.3	2.9	4.1	5.5	7.7	10.1
• Based on $I_H$	A	2	2.6	3.3	4.7	6.1	8.8
<b>Line supply connection</b> U1/L1, V1/L2, W1/L3		Terminal connector	Terminal connector	Terminal connector	Terminal connector	Terminal connector	Terminal connector
• Conductor cross-section	$mm^2$	1 ... 2.5	1 ... 2.5	1 ... 2.5	1 ... 2.5	1 ... 2.5	1 ... 2.5
<b>Motor connection</b> U2, V2, W2		Terminal connector	Terminal connector	Terminal connector	Terminal connector	Terminal connector	Terminal connector
• Conductor cross-section	$mm^2$	1 ... 2.5	1 ... 2.5	1 ... 2.5	1 ... 2.5	1 ... 2.5	1 ... 2.5
<b>PE connection</b>		Included in terminal connector	Included in terminal connector	Included in terminal connector	Included in terminal connector	Included in terminal connector	Included in terminal connector
<b>Motor cable length, max.</b>							
• Without filter, shielded/unshielded	m (ft)	150/150 (492/492)	150/150 (492/492)	150/150 (492/492)	150/150 (492/492)	150/150 (492/492)	150/150 (492/492)
• With integrated filter class A, shielded/unshielded	m (ft)	50/100 (164/328)	50/100 (164/328)	50/100 (164/328)	50/100 (164/328)	50/100 (164/328)	50/100 (164/328)
<b>Degree of protection</b>		IP20	IP20	IP20	IP20	IP20	IP20
<b>Dimensions</b>							
• Width	mm (in)	73 (2.87)	73 (2.87)	73 (2.87)	73 (2.87)	73 (2.87)	73 (2.87)
• Height	mm (in)	196 (7.72)	196 (7.72)	196 (7.72)	196 (7.72)	196 (7.72)	196 (7.72)
• Depth							
- Without operator panel	mm (in)	165 (6.50)	165 (6.50)	165 (6.50)	165 (6.50)	165 (6.50)	165 (6.50)
- With operator panel, max.	mm (in)	238 (9.37)	238 (9.37)	238 (9.37)	238 (9.37)	238 (9.37)	238 (9.37)
<b>Frame size</b>		FSA	FSA	FSA	FSA	FSA	FSA
<b>Weight, approx.</b>							
• Without integrated line filter	kg (lb)	1.3 (2.87)	1.3 (2.87)	1.3 (2.87)	1.4 (3.09)	1.4 (3.09)	1.4 (3.09)
• With integrated line filter	kg (lb)	1.5 (3.31)	1.5 (3.31)	1.5 (3.31)	1.6 (3.53)	1.6 (3.53)	1.6 (3.53)

<sup>1)</sup> The rated output current  $I_N$  and the base-load current  $I_L$  are based on the duty cycle for low overload (LO).

<sup>2)</sup> The base-load current  $I_H$  is based on the duty cycle for high overload (HO).

<sup>3)</sup> Typical values. You can find more information on the internet at: <https://support.industry.siemens.com/cs/document/94059311>

<sup>4)</sup> The input current depends on the motor load and line impedance. The input currents apply for a load at rated power (based on  $I_N$ ) for a line impedance corresponding to  $u_K = 1\%$ . The current values are specified on the rating plate of the Power Module.

# SINAMICS G120 standard converters

0.37 kW to 250 kW (0.5 hp to 400 hp)

## Power Modules

### Technical specifications

Line voltage 380 ... 480 V 3 AC		PM240-2 Power Modules standard variant				
Without integrated line filter		6SL3210-1PE21-1UL0	6SL3210-1PE21-4UL0	6SL3210-1PE21-8UL0	6SL3210-1PE22-7UL0	6SL3210-1PE23-3UL0
With integrated line filter class A		6SL3210-1PE21-1AL0	6SL3210-1PE21-4AL0	6SL3210-1PE21-8AL0	6SL3210-1PE22-7AL0	6SL3210-1PE23-3AL0
<b>Output current</b> at 50 Hz 400 V 3 AC						
• Rated current $I_N^{1)}$	A	10.2	13.2	18	26	32
• Base-load current $I_L^{1)}$	A	10.2	13.2	18	26	32
• Base-load current $I_H^{2)}$	A	7.7	10.2	13.2	18	26
• Maximum current $I_{max}$	A	15.4	20.4	27	39	52
<b>Rated power</b>						
• Based on $I_L$	kW (hp)	4 (5)	5.5 (7.5)	7.5 (10)	11 (15)	15 (20)
• Based on $I_H$	kW (hp)	3 (4)	4 (5)	5.5 (7.5)	7.5 (10)	11 (15)
<b>Rated pulse frequency</b>						
	kHz	4	4	4	4	4
<b>Efficiency <math>\eta</math></b> According to IEC 61800-9-2						
	%	>97.4	>97.6	>97.7	>97.8	>97.9
<b>Power loss <sup>3)</sup></b> According to IEC 61800-9-2 At rated current						
	kW	0.135	0.175	0.229	0.313	0.365
<b>Cooling air requirement</b>						
	m <sup>3</sup> /s (ft <sup>3</sup> /s)	0.0092 (0.325)	0.0092 (0.325)	0.0092 (0.325)	0.0185 (0.65)	0.0185 (0.65)
<b>Sound pressure level</b> $L_{pA}$ (1 m)						
	dB	<62	<62	<62	<65	<65
<b>Input current <sup>4)</sup></b>						
• Rated input current	A	13.3	17.2	22.2	32.6	39.9
• Based on $I_H$	A	11.6	15.3	19.8	27	36
<b>Line supply connection</b> U1/L1, V1/L2, W1/L3						
• Conductor cross-section	mm <sup>2</sup>	1.5 ... 6	1.5 ... 6	1.5 ... 6	6 ... 16	6 ... 16
<b>Motor connection</b> U2, V2, W2						
• Conductor cross-section	mm <sup>2</sup>	1.5 ... 6	1.5 ... 6	1.5 ... 6	6 ... 16	6 ... 16
<b>PE connection</b>						
		Included in terminal connector	Included in terminal connector	Included in terminal connector	Included in terminal connector	Included in terminal connector
<b>Motor cable length, max.</b>						
• Without filter, shielded/unshielded	m (ft)	150/150 (492/492)	150/150 (492/492)	150/150 (492/492)	150/150 (492/492)	150/150 (492/492)
• With integrated filter class A, shielded/unshielded	m (ft)	100/100 (328/328) <sup>5)</sup>	100/100 (328/328) <sup>5)</sup>	100/100 (328/328) <sup>5)</sup>	150/150 (492/492) <sup>5)</sup>	150/150 (492/492) <sup>5)</sup>
<b>Degree of protection</b>						
		IP20	IP20	IP20	IP20	IP20
<b>Dimensions</b>						
• Width	mm (in)	100 (3.94)	100 (3.94)	100 (3.94)	140 (5.51)	140 (5.51)
• Height	mm (in)	292 (11.5)	292 (11.5)	292 (11.5)	355 (13.98)	355 (13.98)
• Depth						
- Without operator panel	mm (in)	165 (6.50)	165 (6.50)	165 (6.50)	165 (6.50)	165 (6.50)
- With operator panel, max.	mm (in)	238 (9.37)	238 (9.37)	238 (9.37)	238 (9.37)	238 (9.37)
<b>Frame size</b>						
		FSB	FSB	FSB	FSC	FSC
<b>Weight, approx.</b>						
• Without integrated line filter	kg (lb)	2.9 (6.39)	2.9 (6.39)	3 (6.62)	4.7 (10.4)	4.8 (10.6)
• With integrated line filter	kg (lb)	3.1 (6.84)	3.1 (6.84)	3.2 (7.06)	5.3 (11.7)	5.4 (11.9)

<sup>1)</sup> The rated output current  $I_N$  and the base-load current  $I_L$  are based on the duty cycle for low overload (LO).

<sup>2)</sup> The base-load current  $I_H$  is based on the duty cycle for high overload (HO).

<sup>3)</sup> Typical values. You can find more information on the internet at: <https://support.industry.siemens.com/cs/document/94059311>

<sup>4)</sup> The input current depends on the motor load and line impedance. The input currents apply for a load at rated power (based on  $I_N$ ) for a line impedance corresponding to  $u_K = 1\%$ . The current values are specified on the rating plate of the Power Module.

<sup>5)</sup> The values apply with low-capacitance CY cables – the max. permissible motor cable length is 50 m (164 ft) (shielded) and 100 m (328 ft) (unshielded) as standard.

## Technical specifications

Line voltage 380 ... 480 V 3 AC		PM240-2 Power Modules standard variant					
		6SL3210-1PE23-8ULO	6SL3210-1PE24-5ULO	6SL3210-1PE26-0ULO	6SL3210-1PE27-5ULO	6SL3210-1PE28-8ULO	6SL3210-1PE31-1ULO
Without integrated line filter							
With integrated line filter class A		6SL3210-1PE23-8ALO	6SL3210-1PE24-5ALO	6SL3210-1PE26-0ALO	6SL3210-1PE27-5ALO	6SL3210-1PE28-8ALO	6SL3210-1PE31-1ALO
<b>Output current</b> at 50 Hz 400 V 3 AC							
• Rated current $I_N^{1)}$	A	38	45	60	75	90	110
• Base-load current $I_L^{1)}$	A	38	45	60	75	90	110
• Base-load current $I_H^{2)}$	A	32	38	45	60	75	90
• Maximum current $I_{max}$	A	64	76	90	120	150	180
<b>Rated power</b>							
• Based on $I_L$	kW (hp)	18.5 (25)	22 (30)	30 (40)	37 (50)	45 (60)	55 (75)
• Based on $I_H$	kW (hp)	15 (20)	18.5 (25)	22 (30)	30 (40)	37 (50)	45 (60)
<b>Rated pulse frequency</b>		kHz	4	4	4	4	4
<b>Efficiency <math>\eta</math></b> According to IEC 61800-9-2		%	>97.2	>97.2	>97.5	>97.3	>97.4
<b>Power loss <sup>3)</sup></b> According to IEC 61800-9-2 At rated current							
• Without integrated line filter	kW	0.584	0.713	0.848	1.12	1.31	1.69
• With integrated line filter	kW	0.587	0.716	0.854	1.13	1.32	1.70
<b>Cooling air requirement</b>		$m^3/s$ (ft <sup>3</sup> /s)	0.055 (1.94)	0.055 (1.94)	0.055 (1.94)	0.055 (1.94)	0.083 (2.93)
<b>Sound pressure level</b> $L_{pA}$ (1 m)		dB	45 ... 65 <sup>4)</sup>	45 ... 65 <sup>4)</sup>	45 ... 65 <sup>4)</sup>	45 ... 65 <sup>4)</sup>	44 ... 62 <sup>4)</sup>
<b>Input current <sup>5)</sup></b>							
• Rated input current	A	36	42	57	70	86	104
• Based on $I_H$	A	33	38	47	62	78	94
<b>Line supply connection</b> U1/L1, V1/L2, W1/L3							
• Conductor cross-section	mm <sup>2</sup>	10 ... 35	10 ... 35	10 ... 35	10 ... 35	25 ... 70	25 ... 70
<b>Motor connection</b> U2, V2, W2							
• Conductor cross-section	mm <sup>2</sup>	10 ... 35	10 ... 35	10 ... 35	10 ... 35	25 ... 70	25 ... 70
<b>PE connection</b>							
			Screw terminals	Screw terminals	Screw terminals	Screw terminals	Screw terminals
<b>Motor cable length, max.</b>							
• Shielded	m (ft)	200 (656)	200 (656)	200 (656)	200 (656)	200 (656)	200 (656)
• Unshielded	m (ft)	300 (984)	300 (984)	300 (984)	300 (984)	300 (984)	300 (984)
<b>Degree of protection</b>			IP20	IP20	IP20	IP20	IP20
<b>Dimensions</b>							
• Width	mm (in)	200 (7.87)	200 (7.87)	200 (7.87)	200 (7.87)	275 (10.83)	275 (10.83)
• Height	mm (in)	472 (18.58)	472 (18.58)	472 (18.58)	472 (18.58)	551 (21.69)	551 (21.69)
• Depth							
- Without operator panel	mm (in)	237 (9.33)	237 (9.33)	237 (9.33)	237 (9.33)	237 (9.33)	237 (9.33)
- With operator panel, max.	mm (in)	268 (10.55)	268 (10.55)	268 (10.55)	268 (10.55)	268 (10.55)	268 (10.55)
<b>Frame size</b>			FSD	FSD	FSD	FSE	FSE
<b>Weight, approx.</b>							
• Without integrated line filter	kg (lb)	16 (35.3)	16 (35.3)	17 (37.5)	17 (37.5)	26 (57.3)	26 (57.3)
• With integrated line filter	kg (lb)	17.5 (38.6)	17.5 (38.6)	18.5 (40.8)	18.5 (40.8)	28 (61.7)	28 (61.7)

<sup>1)</sup> The rated output current  $I_N$  and the base-load current  $I_L$  are based on the duty cycle for low overload (LO).

<sup>2)</sup> The base-load current  $I_H$  is based on the duty cycle for high overload (HO).

<sup>3)</sup> Typical values. You can find more information on the internet at:  
<https://support.industry.siemens.com/cs/document/94059311>

<sup>4)</sup> Values dependent on ambient temperature and utilization.

<sup>5)</sup> The input current depends on the motor load and line impedance. The input currents apply for a load at rated power (based on  $I_N$ ) for a line impedance corresponding to  $u_K = 1\%$ . The current values are specified on the rating plate of the Power Module.

# SINAMICS G120 standard converters

0.37 kW to 250 kW (0.5 hp to 400 hp)

## Power Modules

### Technical specifications

Line voltage 380 ... 480 V 3 AC		PM240-2 Power Modules standard variant			
Without integrated line filter		6SL3210-1PE31-5UL0	6SL3210-1PE31-8UL0	6SL3210-1PE32-1UL0	6SL3210-1PE32-5UL0
With integrated line filter class A		6SL3210-1PE31-5AL0	6SL3210-1PE31-8AL0	6SL3210-1PE32-1AL0	6SL3210-1PE32-5AL0
<b>Output current</b> at 50 Hz 400 V 3 AC					
• Rated current $I_N^{1)}$	A	145	178	205	250
• Base-load current $I_L^{1)}$	A	145	178	205	250
• Base-load current $I_H^{2)}$	A	110	145	178	205
• Maximum current $I_{max}$	A	220	290	356	410
<b>Rated power</b>					
• Based on $I_L$	kW (hp)	75 (100)	90 (125)	110 (150)	132 (200)
• Based on $I_H$	kW (hp)	55 (75)	75 (100)	90 (125)	110 (150)
<b>Rated pulse frequency</b>		kHz	2	2	2
<b>Efficiency <math>\eta</math></b> According to IEC 61800-9-2		%	>97.6	>97.4	>97.9
<b>Power loss <sup>3)</sup></b> According to IEC 61800-9-2 At rated current					
• Without integrated line filter	kW	1.97	2.56	2.37	3.10
• With integrated line filter	kW	1.98	2.58	2.39	3.14
<b>Cooling air requirement</b>		$m^3/s$ ( $ft^3/s$ )	0.153 (5.40)	0.153 (5.40)	0.153 (5.40)
<b>Sound pressure level</b> $L_{pA}$ (1 m)		dB	56 ... 68 <sup>4)</sup>	56 ... 68 <sup>4)</sup>	56 ... 68 <sup>4)</sup>
<b>Input current <sup>5)</sup></b>					
• Rated input current	A	140	172	198	242
• Based on $I_H$	A	117	154	189	218
<b>Line supply connection</b> U1/L1, V1/L2, W1/L3			M10 screw stud	M10 screw stud	M10 screw stud
• Conductor cross-section	$mm^2$	35 ... 2 × 120	35 ... 2 × 120	35 ... 2 × 120	35 ... 2 × 120
<b>Motor connection</b> U2, V2, W2			M10 screw stud	M10 screw stud	M10 screw stud
• Conductor cross-section	$mm^2$	35 ... 2 × 120	35 ... 2 × 120	35 ... 2 × 120	35 ... 2 × 120
<b>PE connection</b>			M10 screw stud	M10 screw stud	M10 screw stud
<b>Motor cable length, max.</b>					
• Shielded	m (ft)	300 (984)	300 (984)	300 (984)	300 (984)
• Unshielded	m (ft)	450 (1476)	450 (1476)	450 (1476)	450 (1476)
<b>Degree of protection</b>			IP20	IP20	IP20
<b>Dimensions</b>					
• Width	mm (in)	305 (12.01)	305 (12.01)	305 (12.01)	305 (12.01)
• Height	mm (in)	708 (27.87)	708 (27.87)	708 (27.87)	708 (27.87)
• Depth					
- Without operator panel	mm (in)	357 (14.06)	357 (14.06)	357 (14.06)	357 (14.06)
- With operator panel, max.	mm (in)	388 (15.28)	388 (15.28)	388 (15.28)	388 (15.28)
<b>Frame size</b>			FSF	FSF	FSF
<b>Weight, approx.</b>					
• Without integrated line filter	kg (lb)	57 (126)	57 (126)	61 (135)	61 (135)
• With integrated line filter	kg (lb)	63 (139)	63 (139)	65 (143)	65 (143)

<sup>1)</sup> The rated output current  $I_N$  and the base-load current  $I_L$  are based on the duty cycle for low overload (LO).

<sup>2)</sup> The base-load current  $I_H$  is based on the duty cycle for high overload (HO).

<sup>3)</sup> Typical values. You can find more information on the internet at:  
<https://support.industry.siemens.com/cs/document/94059311>

<sup>4)</sup> Values dependent on ambient temperature and utilization.

<sup>5)</sup> The input current depends on the motor load and line impedance. The input currents apply for a load at rated power (based on  $I_N$ ) for a line impedance corresponding to  $u_K = 1\%$ . The current values are specified on the rating plate of the Power Module.



# SINAMICS G120 standard converters

0.37 kW to 250 kW (0.5 hp to 400 hp)

## Power Modules

### Technical specifications

Line voltage 380 ... 480 V 3 AC		PM240-2 Power Modules standard variant		
With integrated line filter Category C2		6SL3210-1PE33-0AL0	6SL3210-1PE33-7AL0	6SL3210-1PE34-8AL0
With integrated line filter Category C3		6SL3210-1PE33-0CLO	6SL3210-1PE33-7CLO	6SL3210-1PE34-8CLO
<b>Output current</b> at 50 Hz 400 V 3 AC				
• Rated current $I_N^{1)}$	A	302	370	477
• Base-load current $I_L^{1)}$	A	302	370	477
• Base-load current $I_H^{2)}$	A	250	302	370
• Maximum current $I_{max}$	A	500	604	740
<b>Rated power</b>				
• Based on $I_L$	kW (hp)	160 (250)	200 (300)	250 (400)
• Based on $I_H$	kW (hp)	132 (200)	160 (250)	200 (300)
<b>Rated pulse frequency</b>		kHz	2	2
<b>Efficiency <math>\eta</math></b> According to IEC 61800-9-2		%	>97.9	>97.8
<b>Power loss <sup>3)</sup></b> According to IEC 61800-9-2 At rated current		kW	3.66	4.61
<b>Cooling air requirement</b>		$m^3/s$ (ft <sup>3</sup> /s)	0.21 (7.42)	0.21 (7.42)
<b>Sound pressure level</b> $L_{pA}$ (1 m)		dB	<74.7	<74.7
<b>Input current <sup>4)</sup></b>				
• Rated input current	A	300	365	470
• Based on $I_H$	A	275	330	400
<b>Line supply connection</b> U1/L1, V1/L2, W1/L3		M10 screw stud	M10 screw stud	M10 screw stud
• Conductor cross-section	mm <sup>2</sup>	35 ... 2 × 185	35 ... 2 × 185	35 ... 2 × 185
<b>Motor connection</b> U2, V2, W2		M10 screw stud	M10 screw stud	M10 screw stud
• Conductor cross-section	mm <sup>2</sup>	35 ... 2 × 185	35 ... 2 × 185	35 ... 2 × 185
<b>PE connection</b>		M10 screw stud	M10 screw stud	M10 screw stud
<b>Motor cable length, max.</b>				
• Shielded	m (ft)	300 (984)	300 (984)	300 (984)
• Unshielded	m (ft)	450 (1476)	450 (1476)	450 (1476)
<b>Degree of protection</b>		IP20	IP20	IP20
<b>Dimensions</b>				
• Width	mm (in)	305 (12.01)	305 (12.01)	305 (12.01)
• Height	mm (in)	1000 (39.37)	1000 (39.37)	1000 (39.37)
• Depth				
- Without operator panel	mm (in)	357 (14.06)	357 (14.06)	357 (14.06)
- With operator panel	mm (in)	388 (15.28)	388 (15.28)	388 (15.28)
<b>Frame size</b>		FSG	FSG	FSG
<b>Weight, approx.</b>				
• With integrated line filter Category C2	kg (lb)	107 (236)	114 (251)	122 (269)
• With integrated line filter Category C3	kg (lb)	105 (231)	113 (249)	120 (265)

<sup>1)</sup> The rated output current  $I_N$  and the base-load current  $I_L$  are based on the duty cycle for low overload (LO).

<sup>2)</sup> The base-load current  $I_H$  is based on the duty cycle for high overload (HO).

<sup>3)</sup> Typical values. You can find more information on the internet at: <https://support.industry.siemens.com/cs/document/94059311>

<sup>4)</sup> The input current depends on the motor load and line impedance. The input currents apply for a load at rated power (based on  $I_N$ ) for a line impedance corresponding to  $u_K = 1\%$ . The current values are specified on the rating plate of the Power Module.

# SINAMICS G120 standard converters

0.37 kW to 250 kW (0.5 hp to 400 hp)

## Power Modules

### Technical specifications

Line voltage 500 ... 690 V 3 AC		PM240-2 Power Modules standard variant					
		6SL3210-1PH21-4UL0	6SL3210-1PH22-0UL0	6SL3210-1PH22-3UL0	6SL3210-1PH22-7UL0	6SL3210-1PH23-5UL0	6SL3210-1PH24-2UL0
Without integrated line filter							
With integrated line filter class A		6SL3210-1PH21-4AL0	6SL3210-1PH22-0AL0	6SL3210-1PH22-3AL0	6SL3210-1PH22-7AL0	6SL3210-1PH23-5AL0	6SL3210-1PH24-2AL0
<b>Output current</b> at 50 Hz 690 V 3 AC							
• Rated current $I_N^{1)}$	A	14	19	23	27	35	42
• Base-load current $I_L^{1)}$	A	14	19	23	27	35	42
• Base-load current $I_H^{2)}$	A	11	14	19	23	27	35
• Maximum current $I_{max}$	A	22	29	38	46	54	70
<b>Rated power</b>							
• Based on $I_L$	kW (hp)	11 (10)	15 (15)	18.5 (20)	22 (25)	30 (30)	37 (40)
• Based on $I_H$	kW (hp)	7.5 (7.5)	11 (10)	15 (15)	18.5 (20)	22 (25)	30 (30)
<b>Rated pulse frequency</b>		kHz	2	2	2	2	2
<b>Efficiency <math>\eta</math></b> According to IEC 61800-9-2		%	>97.3	>97.5	>97.6	>97.6	>97.6
<b>Power loss <sup>3)</sup></b> According to IEC 61800-9-2 At rated current							
• Without integrated line filter	kW	0.359	0.452	0.533	0.614	0.797	0.971
• With integrated line filter	kW	0.360	0.453	0.535	0.617	0.802	0.980
<b>Cooling air requirement</b>		m <sup>3</sup> /s (ft <sup>3</sup> /s)	0.055 (1.94)	0.055 (1.94)	0.055 (1.94)	0.055 (1.94)	0.055 (1.94)
<b>Sound pressure level</b> $L_{pA}$ (1 m)		dB	45 ... 65 <sup>4)</sup>	45 ... 65 <sup>4)</sup>	45 ... 65 <sup>4)</sup>	45 ... 65 <sup>4)</sup>	45 ... 65 <sup>4)</sup>
<b>Input current <sup>5)</sup></b>							
• Rated input current	A	14	18	22	25	33	40
• Based on $I_H$	A	11	14	20	24	28	36
<b>Line supply connection</b> U1/L1, V1/L2, W1/L3							
• Conductor cross-section	mm <sup>2</sup>	10 ... 35	10 ... 35	10 ... 35	10 ... 35	10 ... 35	10 ... 35
<b>Motor connection</b> U2, V2, W2							
• Conductor cross-section	mm <sup>2</sup>	10 ... 35	10 ... 35	10 ... 35	10 ... 35	10 ... 35	10 ... 35
<b>PE connection</b>							
• Motor cable length, max.		Screw terminals	Screw terminals	Screw terminals	Screw terminals	Screw terminals	Screw terminals
• Shielded	m (ft)	200 (656)	200 (656)	200 (656)	200 (656)	200 (656)	200 (656)
• Unshielded	m (ft)	300 (984)	300 (984)	300 (984)	300 (984)	300 (984)	300 (984)
<b>Degree of protection</b>							
		IP20	IP20	IP20	IP20	IP20	IP20
<b>Dimensions</b>							
• Width	mm (in)	200 (7.87)	200 (7.87)	200 (7.87)	200 (7.87)	200 (7.87)	200 (7.87)
• Height	mm (in)	472 (18.58)	472 (18.58)	472 (18.58)	472 (18.58)	472 (18.58)	472 (18.58)
• Depth							
• Without operator panel	mm (in)	237 (9.33)	237 (9.33)	237 (9.33)	237 (9.33)	237 (9.33)	237 (9.33)
• With operator panel, max.	mm (in)	268 (10.55)	268 (10.55)	268 (10.55)	268 (10.55)	268 (10.55)	268 (10.55)
<b>Frame size</b>							
		FSD	FSD	FSD	FSD	FSD	FSD
<b>Weight, approx.</b>							
• Without integrated line filter	kg (lb)	17 (37.5)	17 (37.5)	17 (37.5)	17 (37.5)	17 (37.5)	17 (37.5)
• With integrated line filter	kg (lb)	18.5 (40.8)	18.5 (40.8)	18.5 (40.8)	18.5 (40.8)	18.5 (40.8)	18.5 (40.8)

<sup>1)</sup> The rated output current  $I_N$  and the base-load current  $I_L$  are based on the duty cycle for low overload (LO).

<sup>2)</sup> The base-load current  $I_H$  is based on the duty cycle for high overload (HO).

<sup>3)</sup> Typical values. You can find more information on the internet at:  
<https://support.industry.siemens.com/cs/document/94059311>

<sup>4)</sup> Values dependent on ambient temperature and utilization.

<sup>5)</sup> The input current depends on the motor load and line impedance. The input currents apply for a load at rated power (based on  $I_N$ ) for a line impedance corresponding to  $u_K = 1\%$ . The current values are specified on the rating plate of the Power Module.

## Technical specifications

Line voltage 500 ... 690 V 3 AC		PM240-2 Power Modules standard variant					
		6SL3210-1PH25-2UL0	6SL3210-1PH26-2UL0	6SL3210-1PH28-0UL0	6SL3210-1PH31-0UL0	6SL3210-1PH31-2UL0	6SL3210-1PH31-4UL0
Without integrated line filter							
With integrated line filter class A		6SL3210-1PH25-2AL0	6SL3210-1PH26-2AL0	6SL3210-1PH28-0AL0	6SL3210-1PH31-0AL0	6SL3210-1PH31-2AL0	6SL3210-1PH31-4AL0
<b>Output current</b> at 50 Hz 690 V 3 AC							
• Rated current $I_N^{1)}$	A	52	62	80	100	115	142
• Base-load current $I_L^{1)}$	A	52	62	80	100	115	142
• Base-load current $I_H^{2)}$	A	42	52	62	80	100	115
• Maximum current $I_{max}$	A	84	104	124	160	200	230
<b>Rated power</b>							
• Based on $I_L$	kW (hp)	45 (50)	55 (60)	75 (75)	90 (100)	110 (100)	132 (125)
• Based on $I_H$	kW (hp)	37 (40)	45 (50)	55 (60)	75 (75)	90 (100)	110 (100)
<b>Rated pulse frequency</b>		kHz	2	2	2	2	2
<b>Efficiency <math>\eta</math></b> According to IEC 61800-9-2		%	>97.8	>97.8	>98.2	>98.1	>98.2
<b>Power loss <sup>3)</sup></b> According to IEC 61800-9-2 At rated current							
• Without integrated line filter	kW	1.11	1.35	1.41	1.80	2.02	2.59
• With integrated line filter	kW	1.12	1.36	1.41	1.82	2.04	2.62
<b>Cooling air requirement</b>		m <sup>3</sup> /s (ft <sup>3</sup> /s)	0.083 (2.93)	0.083 (2.93)	0.153 (5.40)	0.153 (5.40)	0.153 (5.40)
<b>Sound pressure level</b> $L_{pA}$ (1 m)		dB	44 ... 62 <sup>4)</sup>	44 ... 62 <sup>4)</sup>	56 ... 68 <sup>4)</sup>	56 ... 68 <sup>4)</sup>	56 ... 68 <sup>4)</sup>
<b>Input current <sup>5)</sup></b>							
• Rated input current	A	50	59	78	97	111	137
• Based on $I_H$	A	44	54	66	85	106	122
<b>Line supply connection</b> U1/L1, V1/L2, W1/L3							
• Conductor cross-section	mm <sup>2</sup>	25 ... 70	25 ... 70	35 ... 2 x 120	35 ... 2 x 120	35 ... 2 x 120	35 ... 2 x 120
<b>Motor connection</b> U2, V2, W2							
• Conductor cross-section	mm <sup>2</sup>	25 ... 70	25 ... 70	35 ... 2 x 120	35 ... 2 x 120	35 ... 2 x 120	35 ... 2 x 120
<b>PE connection</b>							
• Motor cable length, max.		Screw terminals	Screw terminals	M10 screw stud	M10 screw stud	M10 screw stud	M10 screw stud
• Shielded	m (ft)	200 (656)	200 (656)	300 (984)	300 (984)	300 (984)	300 (984)
• Unshielded	m (ft)	300 (984)	300 (984)	450 (1476)	450 (1476)	450 (1476)	450 (1476)
<b>Degree of protection</b>							
		IP20	IP20	IP20	IP20	IP20	IP20
<b>Dimensions</b>							
• Width	mm (in)	275 (10.83)	275 (10.83)	305 (12.01)	305 (12.01)	305 (12.01)	305 (12.01)
• Height	mm (in)	551 (21.69)	551 (21.69)	708 (27.87)	708 (27.87)	708 (27.87)	708 (27.87)
• Depth							
- Without operator panel	mm (in)	237 (9.33)	237 (9.33)	357 (14.06)	357 (14.06)	357 (14.06)	357 (14.06)
- With operator panel, max.	mm (in)	268 (10.55)	268 (10.55)	388 (15.28)	388 (15.28)	388 (15.28)	388 (15.28)
<b>Frame size</b>							
		FSE	FSE	FSF	FSF	FSF	FSF
<b>Weight, approx.</b>							
• Without integrated line filter	kg (lb)	26 (57.3)	26 (57.3)	60 (132)	60 (132)	60 (132)	60 (132)
• With integrated line filter	kg (lb)	28 (61.7)	28 (61.7)	64 (141)	64 (141)	64 (141)	64 (141)

<sup>1)</sup> The rated output current  $I_N$  and the base-load current  $I_L$  are based on the duty cycle for low overload (LO).

<sup>2)</sup> The base-load current  $I_H$  is based on the duty cycle for high overload (HO).

<sup>3)</sup> Typical values. You can find more information on the internet at: <https://support.industry.siemens.com/cs/document/94059311>

<sup>4)</sup> Values dependent on ambient temperature and utilization.

<sup>5)</sup> The input current depends on the motor load and line impedance. The input currents apply for a load at rated power (based on  $I_N$ ) for a line impedance corresponding to  $u_k = 1\%$ . The current values are specified on the rating plate of the Power Module.

## SINAMICS G120 standard converters

0.37 kW to 250 kW (0.5 hp to 400 hp)

### Power Modules

#### Technical specifications

Line voltage 500 ... 690 V 3 AC With integrated line filter Category C3		PM240-2 Power Modules standard variant		
		6SL3210-1PH31-7CLO	6SL3210-1PH32-1CLO	6SL3210-1PH32-5CLO
<b>Output current</b> at 50 Hz 690 V 3 AC				
• Rated current $I_N^{1)}$	A	171	208	250
• Base-load current $I_L^{1)}$	A	171	208	250
• Base-load current $I_H^{2)}$	A	144	171	208
• Maximum current $I_{max}$	A	288	342	416
<b>Rated power</b>				
• Based on $I_L$	kW (hp)	160 (150)	200 (200)	250 (250)
• Based on $I_H$	kW (hp)	132 (150)	160 (150)	200 (200)
<b>Rated pulse frequency</b>	kHz	2	2	2
<b>Efficiency <math>\eta</math></b> According to IEC 61800-9-2	%	>98.2	>98.2	>98.1
<b>Power loss <sup>3)</sup></b> According to IEC 61800-9-2 At rated current	kW	2.93	3.70	4.63
<b>Cooling air requirement</b>	m <sup>3</sup> /s (ft <sup>3</sup> /s)	0.21 (7.42)	0.21 (7.42)	0.21 (7.42)
<b>Sound pressure level</b> $L_{pA}$ (1 m)	dB	<74.7	<74.7	<74.7
<b>Input current <sup>4)</sup></b>				
• Rated input current	A	170	205	250
• Based on $I_H$	A	160	185	225
<b>Line supply connection</b> U1/L1, V1/L2, W1/L3				
• Conductor cross-section	mm <sup>2</sup>	35 ... 2 × 185	35 ... 2 × 185	35 ... 2 × 185
<b>Motor connection</b> U2, V2, W2				
• Conductor cross-section	mm <sup>2</sup>	35 ... 2 × 185	35 ... 2 × 185	35 ... 2 × 185
<b>PE connection</b>				
		M10 screw stud	M10 screw stud	M10 screw stud
<b>Motor cable length, max.</b>				
• Shielded	m (ft)	300 (984)	300 (984)	300 (984)
• Unshielded	m (ft)	450 (1476)	450 (1476)	450 (1476)
<b>Degree of protection</b>				
		IP20	IP20	IP20
<b>Dimensions</b>				
• Width	mm (in)	305 (12.01)	305 (12.01)	305 (12.01)
• Height	mm (in)	1000 (39.37)	1000 (39.37)	1000 (39.37)
• Depth				
- Without operator panel	mm (in)	357 (14.06)	357 (14.06)	357 (14.06)
- With operator panel	mm (in)	388 (15.28)	388 (15.28)	388 (15.28)
<b>Frame size</b>				
		FSG	FSG	FSG
<b>Weight, approx.</b>				
	kg (lb)	114 (251)	114 (251)	114 (251)

<sup>1)</sup> The rated output current  $I_N$  and the base-load current  $I_L$  are based on the duty cycle for low overload (LO).

<sup>2)</sup> The base-load current  $I_H$  is based on the duty cycle for high overload (HO).

<sup>3)</sup> Typical values. You can find more information on the internet at:  
<https://support.industry.siemens.com/cs/document/94059311>

<sup>4)</sup> The input current depends on the motor load and line impedance. The input currents apply for a load at rated power (based on  $I_N$ ) for a line impedance corresponding to  $u_K = 1\%$ . The current values are specified on the rating plate of the Power Module.

# SINAMICS G120 standard converters

0.37 kW to 250 kW (0.5 hp to 400 hp)

## Power Modules

### Technical specifications

#### PM250 Power Modules

Line voltage 380 ... 480 V 3 AC		PM250 Power Modules		
With integrated line filter		6SL3225-0BE25-5AA1	6SL3225-0BE27-5AA1	6SL3225-0BE31-1AA1
<b>Output current</b> at 50 Hz 400 V 3 AC				
• Rated current $I_N^{1)}$	A	18	25	32
• Base-load current $I_L^{1)}$	A	18	25	32
• Base-load current $I_H^{2)}$	A	13.2	19	26
• Maximum current $I_{max}$	A	26.4	38	52
<b>Rated power</b>				
• Based on $I_L$	kW (hp)	7.5 (10)	11 (15)	15 (20)
• Based on $I_H$	kW (hp)	5.5 (7.5)	7.5 (10)	11 (15)
<b>Rated pulse frequency</b>	kHz	4	4	4
<b>Efficiency <math>\eta</math></b>	%	97.0	96.5	97.4
<b>Power loss <sup>3)</sup></b> At rated current	kW	0.298	0.488	0.472
<b>Cooling air requirement</b>	m <sup>3</sup> /s (ft <sup>3</sup> /s)	0.038 (1.34)	0.038 (1.34)	0.038 (1.34)
<b>Sound pressure level</b> $L_{pA}$ (1 m)	dB	<60	<60	<60
<b>Input current <sup>4)</sup></b>				
• Rated input current	A	18	25	32
• Based on $I_H$	A	13.2	19	26
<b>Line supply connection</b> U1/L1, V1/L2, W1/L3				
• Conductor cross-section	mm <sup>2</sup>	2.5 ... 10	2.5 ... 10	2.5 ... 10
<b>Motor connection</b> U2, V2, W2				
• Conductor cross-section	mm <sup>2</sup>	2.5 ... 10	2.5 ... 10	2.5 ... 10
<b>PE connection</b>				
		On housing with M5 screw	On housing with M5 screw	On housing with M5 screw
<b>Motor cable length, max.</b>				
• Shielded	m (ft)	25 (82)	25 (82)	25 (82)
• Unshielded	m (ft)	100 (328)	100 (328)	100 (328)
<b>Degree of protection</b>				
		IP20	IP20	IP20
<b>Dimensions</b>				
• Width	mm (in)	189 (7.44)	189 (7.44)	189 (7.44)
• Height	mm (in)	334 (13.15)	334 (13.15)	334 (13.15)
• Depth				
- Without operator panel	mm (in)	185 (7.28)	185 (7.28)	185 (7.28)
- With operator panel, max.	mm (in)	258 (10.16)	258 (10.16)	258 (10.16)
<b>Frame size</b>				
		FSC	FSC	FSC
<b>Weight, approx.</b>	kg (lb)	7.5 (16.5)	7.5 (16.5)	7.5 (16.5)

<sup>1)</sup> The rated output current  $I_N$  and the base-load current  $I_L$  are based on the duty cycle for low overload (LO).

<sup>2)</sup> The base-load current  $I_H$  is based on the duty cycle for high overload (HO).

<sup>3)</sup> Typical values. You can find more information on the internet at:  
<https://support.industry.siemens.com/cs/document/94059311>

<sup>4)</sup> The input current depends on the motor load and line impedance. The input currents apply for a load at rated power (based on  $I_N$ ) for a line impedance corresponding to  $u_K = 1\%$ . The rated input currents apply for a load at rated power (based on  $I_N$ ) – these current values are specified on the rating plate.

# SINAMICS G120 standard converters

0.37 kW to 250 kW (0.5 hp to 400 hp)

## Power Modules

### Technical specifications

Line voltage 380 ... 480 V 3 AC		PM250 Power Modules		
Without integrated line filter		6SL3225-0BE31-5UA0	6SL3225-0BE31-8UA0	6SL3225-0BE32-2UA0
With integrated line filter		6SL3225-0BE31-5AA0	6SL3225-0BE31-8AA0	6SL3225-0BE32-2AA0
<b>Output current</b> at 50 Hz 400 V 3 AC				
• Rated current $I_N^{1)}$	A	38	45	60
• Base-load current $I_L^{1)}$	A	38	45	60
• Base-load current $I_H^{2)}$	A	32	38	45
• Maximum current $I_{max}$	A	64	76	90
<b>Rated power</b>				
• Based on $I_L$	kW (hp)	18.5 (25)	22 (30)	30 (40)
• Based on $I_H$	kW (hp)	15 (20)	18.5 (25)	22 (30)
<b>Rated pulse frequency</b>		kHz	4	4
<b>Efficiency <math>\eta</math></b>		%	>97.3	>97.3
<b>Power loss <sup>3)</sup></b> At rated current		kW	0.577	0.692
<b>Cooling air requirement</b>		m <sup>3</sup> /s (ft <sup>3</sup> /s)	0.022 (0.78)	0.022 (0.78)
<b>Sound pressure level</b> $L_{pA}$ (1 m)		dB	<60	<61
<b>Input current <sup>4)</sup></b>				
• Rated input current	A	36	42	56
• Based on $I_H$	A	30	36	42
<b>Line supply connection</b> U1/L1, V1/L2, W1/L3		M6 screw studs		
• Conductor cross-section	mm <sup>2</sup>	10 ... 35	10 ... 35	10 ... 35
<b>Motor connection</b> U2, V2, W2		M6 screw studs		
• Conductor cross-section	mm <sup>2</sup>	10 ... 35	10 ... 35	10 ... 35
<b>PE connection</b>		On housing with M6 screw		
<b>Motor cable length <sup>5)</sup>, max.</b>				
• Shielded	m (ft)	50 (164)	50 (164)	50 (164)
• Unshielded	m (ft)	100 (328)	100 (328)	100 (328)
<b>Degree of protection</b>		IP20	IP20	IP20
<b>Dimensions</b>				
• Width	mm (in)	275 (10.83)	275 (10.83)	275 (10.83)
• Height				
- Without integrated line filter	mm (in)	419 (16.50)	419 (16.50)	419 (16.50)
- With integrated line filter	mm (in)	512 (20.16)	512 (20.16)	512 (20.16)
• Depth				
- Without operator panel	mm (in)	204 (8.03)	204 (8.03)	204 (8.03)
- With operator panel, max.	mm (in)	268 (10.55)	268 (10.55)	268 (10.55)
<b>Frame size</b>		FSD	FSD	FSD
<b>Weight, approx.</b>				
• Without integrated line filter	kg (lb)	13 (28.7)	13 (28.7)	13 (28.7)
• With integrated line filter	kg (lb)	15 (33.1)	15 (33.1)	16 (35.3)

<sup>1)</sup> The rated output current  $I_N$  and the base-load current  $I_L$  are based on the duty cycle for low overload (LO).

<sup>2)</sup> The base-load current  $I_H$  is based on the duty cycle for high overload (HO).

<sup>3)</sup> Typical values. You can find more information on the internet at:  
<https://support.industry.siemens.com/cs/document/94059311>

<sup>4)</sup> The input current depends on the motor load and line impedance and applies for a line impedance corresponding to  $u_K = 1\%$ . The rated input currents apply for a load at rated power (based on  $I_N$ ) – these current values are specified on the rating plate.

<sup>5)</sup> Max. motor cable length 25 m (82 ft) (shielded) for PM250 Power Modules with integrated line filter to maintain the limit values of EN 61800-3 Category C2.

## Technical specifications

Line voltage 380 ... 480 V 3 AC		PM250 Power Modules				
Without integrated line filter		6SL3225-0BE33-0UA0	6SL3225-0BE33-7UA0	6SL3225-0BE34-5UA0	6SL3225-0BE35-5UA0	6SL3225-0BE37-5UA0
With integrated line filter		6SL3225-0BE33-0AA0	6SL3225-0BE33-7AA0	6SL3225-0BE34-5AA0	6SL3225-0BE35-5AA0	6SL3225-0BE37-5AA0
<b>Output current</b> at 50 Hz 400 V 3 AC						
• Rated current $I_N^{1)}$	A	75	90	110	145	178
• Base-load current $I_L^{1)}$	A	75	90	110	145	178
• Base-load current $I_H^{2)}$	A	60	75	90	110	145
• Maximum current $I_{max}$	A	120	150	180	220	290
<b>Rated power</b>						
• Based on $I_L$	kW (hp)	37 (50)	45 (60)	55 (75)	75 (100)	90 (125)
• Based on $I_H$	kW (hp)	30 (40)	37 (50)	45 (60)	55 (75)	75 (100)
<b>Rated pulse frequency</b>	kHz	4	4	4	4	4
<b>Efficiency <math>\eta</math></b>	%	>97.6	>97.6	>97.4	>97.3	>97.4
<b>Power loss <sup>3)</sup></b> At rated current	kW	1.008	1.216	1.608	2.230	2.639
<b>Cooling air requirement</b>	m <sup>3</sup> /s (ft <sup>3</sup> /s)	0.022 (0.78)	0.039 (1.38)	0.094 (3.32)	0.094 (3.32)	0.117 (4.13)
<b>Sound pressure level</b> $L_{pA}$ (1 m)	dB	<60	<62	<60	<60	<65
<b>Input current <sup>4)</sup></b>						
• Rated input current	A	70	84	102	135	166
• Based on $I_H$	A	56	70	84	102	135
<b>Line supply connection</b> U1/L1, V1/L2, W1/L3						
• Conductor cross-section, max.	mm <sup>2</sup>	10 ... 50	10 ... 50	25 ... 120	25 ... 120	25 ... 120
<b>Motor connection</b> U2, V2, W2						
• Conductor cross-section, max.	mm <sup>2</sup>	10 ... 50	10 ... 50	25 ... 120	25 ... 120	25 ... 120
<b>PE connection</b>						
		On housing with M6 screw	On housing with M6 screw	On housing with M8 screw	On housing with M8 screw	On housing with M8 screw
<b>Motor cable length <sup>5)</sup>, max.</b>						
• Shielded	m (ft)	50 (164)	50 (164)	50 (164)	50 (164)	50 (164)
• Unshielded	m (ft)	100 (328)	100 (328)	100 (328)	100 (328)	100 (328)
<b>Degree of protection</b>						
		IP20	IP20	IP20	IP20	IP20
<b>Dimensions</b>						
• Width	mm (in)	275 (10.83)	275 (10.83)	350 (13.78)	350 (13.78)	350 (13.78)
• Height						
- Without integrated line filter	mm (in)	499 (19.65)	499 (19.65)	634 (24.96)	634 (24.96)	634 (24.96)
- With integrated line filter	mm (in)	635 (25.0)	635 (25.0)	934 (36.77)	934 (36.77)	934 (36.77)
• Depth						
- Without operator panel	mm (in)	204 (8.03)	204 (8.03)	316 (12.44)	316 (12.44)	316 (12.44)
- With operator panel, max.	mm (in)	268 (10.55)	268 (10.55)	380 (14.96)	380 (14.96)	380 (14.96)
<b>Frame size</b>						
		FSE	FSE	FSF	FSF	FSF
<b>Weight, approx.</b>						
• Without integrated line filter	kg (lb)	14 (30.9)	14 (30.9)	35 (77.2)	35 (77.2)	35 (77.2)
• With integrated line filter	kg (lb)	21 (46.3)	21 (46.3)	51 (112.5)	51 (112.5)	51 (112.5)

<sup>1)</sup> The rated output current  $I_N$  and the base-load current  $I_L$  are based on the duty cycle for low overload (LO).

<sup>2)</sup> The base-load current  $I_H$  is based on the duty cycle for high overload (HO).

<sup>3)</sup> Typical values. You can find more information on the internet at:  
<https://support.industry.siemens.com/cs/document/94059311>

<sup>4)</sup> The input current depends on the motor load and line impedance and applies for a line impedance corresponding to  $u_K = 1\%$ . The rated input currents apply for a load at rated power (based on  $I_N$ ) – these current values are specified on the rating plate.

<sup>5)</sup> Max. motor cable length 25 m (82 ft) (shielded) for PM250 Power Modules with integrated line filter to maintain the limit values of EN 61800-3 Category C2.

## SINAMICS G120 standard converters

0.37 kW to 250 kW (0.5 hp to 400 hp)

### Power Modules

#### Characteristic curves

##### Derating data, PM240-2 Power Modules

###### Pulse frequency

Rated power <sup>1)</sup> at 50 Hz 200 V 1 AC/3 AC		Rated output current in A for a pulse frequency of							
kW	hp	2 kHz	4 kHz	6 kHz	8 kHz	10 kHz	12 kHz	14 kHz	16 kHz
0.55	0.75	3.2	3.2	2.7	2.2	1.9	1.6	1.4	1.3
0.75	1	4.2	4.2	3.6	2.9	2.5	2.1	1.9	1.7
1.1	1.5	6	6	5.1	4.2	3.6	2.3	2.7	2.4
1.5	2	7.4	7.4	6.3	5.2	4.4	3.7	3.3	3
2.2	3	10.4	10.4	8.8	7.3	6.2	5.2	4.7	4.2
3	4	13.6	13.6	11.6	9.5	8.2	6.8	6.1	5.4
4	5	17.5	17.5	14.9	12.3	10.5	8.8	7.9	7
5.5	7.5	22	22	18.7	15.4	13.2	11	9.9	8.8
7.5	10	28	28	23.8	19.6	16.8	14	12.6	11.2
11	15	42	42	35.7	29.4	25.2	21	18.9	16.8
15	20	54	54	45.9	37.8	32.4	27	24.3	21.6
18.5	25	68	68	57.8	47.6	40.8	34	30.6	27.2
22	30	80	80	68	56	48	40	36	32
30	40	104	104	88.4	72.8	62.4	52	46.8	41.6
37	50	130	130	110.5	91	–	–	–	–
45	60	154	154	130.9	107.8	–	–	–	–
55	75	178	178	151.3	124.6	–	–	–	–

Rated power <sup>1)</sup> at 50 Hz 400 V 3 AC		Rated output current in A for a pulse frequency of							
kW	hp	2 kHz	4 kHz	6 kHz	8 kHz	10 kHz	12 kHz	14 kHz	16 kHz
0.55	0.75	1.7	1.7	1.4	1.2	1	0.9	0.8	0.7
0.75	1	2.2	2.2	1.9	1.5	1.3	1.1	1	0.9
1.1	1.5	3.1	3.1	2.6	2.2	1.9	1.6	1.4	1.2
1.5	2	4.1	4.1	3.5	2.9	2.5	2.1	1.8	1.6
2.2	3	5.9	5.9	5	4.1	3.5	3	2.7	2.4
3	4	7.7	7.7	6.5	5.4	4.6	3.9	3.5	3.1
4	5	10.2	10.2	8.7	7.1	6.1	5.1	4.6	4.1
5.5	7.5	13.2	13.2	11.2	9.2	7.9	6.6	5.9	5.3
7.5	10	18	18	15.3	12.6	10.8	9	8.1	7.2
11	15	26	26	22.1	18.2	15.6	13	11.7	10.4
15	20	32	32	27.2	22.4	19.2	16	14.4	12.8
18.5	25	38	38	32.3	26.6	22.8	19	17.1	15.2
22	30	45	45	38.3	31.5	27	22.5	20.3	18
30	40	60	60	51	42	36	30	27	24
37	50	75	75	63.8	52.5	45	37.5	33.8	30
45	60	90	90	76.5	63	54	45	40.5	36
55	75	110	110	93.5	77	–	–	–	–
75	100	145	145	123.3	101.5	–	–	–	–
90	125	178	178	151.3	124.6	–	–	–	–
110	150	205	143.5	102.5	82	–	–	–	–
132	200	250	175	125	100	–	–	–	–
160	250	302	211.4	151	120.8	–	–	–	–
200	300	370	259	185	148	–	–	–	–
250	400	477	333.9	238.5	190.8	–	–	–	–

<sup>1)</sup> Rated power based on the rated output current  $I_N$ . The rated output current  $I_N$  is based on the duty cycle for low overload (LO).



## Characteristic curves

### Derating data, PM240-2 Power Modules (continued)

Rated power <sup>1)</sup> at 50 Hz 690 V 3 AC		Rated output current in A for a pulse frequency of							
kW	hp	2 kHz	4 kHz	6 kHz	8 kHz	10 kHz	12 kHz	14 kHz	16 kHz
11	10	14	8.4	–	–	–	–	–	–
15	15	19	11.4	–	–	–	–	–	–
18.5	20	23	13.8	–	–	–	–	–	–
22	25	27	16.2	–	–	–	–	–	–
30	30	35	21	–	–	–	–	–	–
37	40	42	25.2	–	–	–	–	–	–
45	50	52	31.2	–	–	–	–	–	–
55	60	62	37.2	–	–	–	–	–	–
75	75	80	48	–	–	–	–	–	–
90	100	100	60	–	–	–	–	–	–
110	100	115	69	–	–	–	–	–	–
132	125	142	85.2	–	–	–	–	–	–
160	150	171	102.6	–	–	–	–	–	–
200	200	208	124.8	–	–	–	–	–	–
250	250	250	150	–	–	–	–	–	–

The permissible motor cable length depends on the cable type and the pulse frequency.

### Ambient temperature

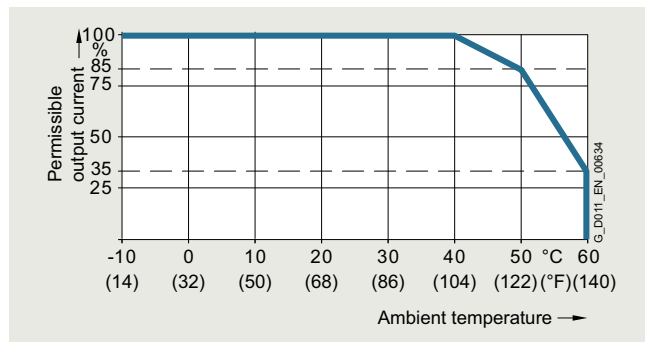

Permissible output current as a function of ambient temperature for low overload (LO) for PM240-2 Power Modules  
FSA to FSC at 200 V and 400 V  
FSD to FSF at 690 V  
FSG at 400 V

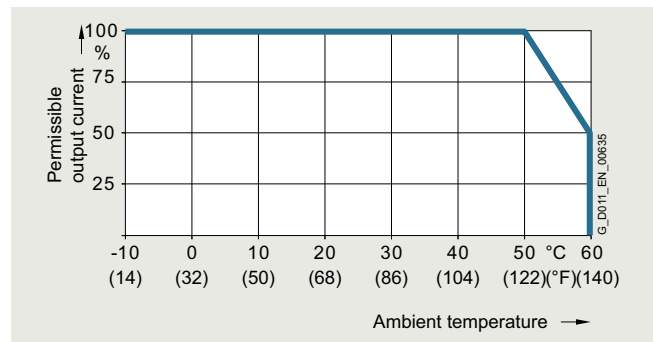

Permissible output current as a function of ambient temperature for high overload (HO) for PM240-2 Power Modules  
FSA to FSC at 200 V and 400 V  
FSD to FSF at 690 V  
FSG at 400 V and 690 V

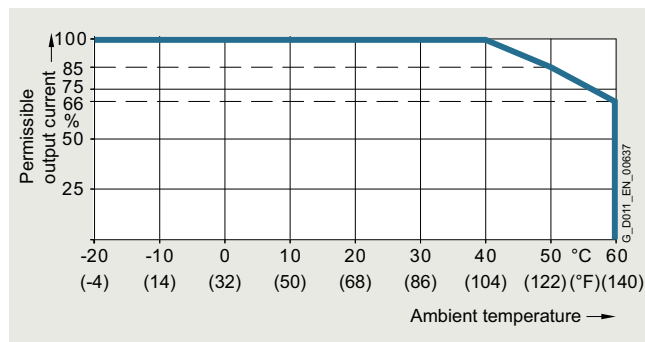

Permissible output current as a function of ambient temperature for low overload (LO) for PM240-2 Power Modules  
FSD to FSF at 200 V and 400 V

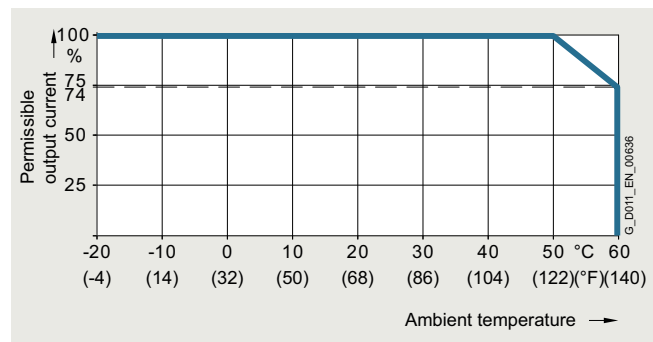

Permissible output current as a function of ambient temperature for high overload (HO) for PM240-2 Power Modules  
FSD to FSF at 200 V and 400 V

The operating temperature ranges of the Control Units should be taken into account. [The temperature ranges are specified in the section Technical specifications under Control Units.](#)

<sup>1)</sup> Rated power based on the rated output current  $I_N$ . The rated output current  $I_N$  is based on the duty cycle for low overload (LO).

## SINAMICS G120 standard converters

0.37 kW to 250 kW (0.5 hp to 400 hp)

### Power Modules

#### Characteristic curves

##### Derating data, PM240-2 Power Modules (continued)

###### Installation altitude

Permissible line supplies as a function of the installation altitude

- Installation altitude up to 2000 m (6562 ft) above sea level
  - Connection to every supply system permitted for the converter
- Installation altitudes between 2000 m (6562 ft) and 4000 m (13124 ft) above sea level
  - Connection only to a TN system with grounded neutral point
  - TN systems with grounded line conductor are not permitted
  - The TN line system with grounded neutral point can also be supplied using an isolation transformer
  - The phase against phase voltage does not have to be reduced

The connected motors, power elements and components must be considered separately.

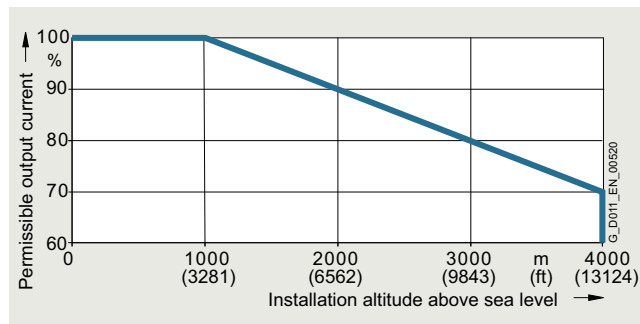

Permissible output current as a function of the installation altitude for PM240-2 Power Modules at 40 °C for low overload (LO)

###### System operating voltage

The rated output current is constant within the respective supply voltage range.

More information on the derating data of the PM240-2 Power Modules is available in the Hardware Installation Manual on the internet at:

[www.siemens.com/sinamics-g120/documentation](http://www.siemens.com/sinamics-g120/documentation)

## Characteristic curves

### Derating data, PM250 Power Modules

#### Pulse frequency

Rated power at 400 V 3 AC		Rated output current in A for a pulse frequency of						
kW	hp	4 kHz	6 kHz	8 kHz	10 kHz	12 kHz	14 kHz	16 kHz
7.5	10	18	12.5	11.9	10.6	9.2	7.9	6.6
11	15	25	18.1	17.1	15.2	13.3	11.4	9.5
15	20	32	24.7	23.4	20.8	18.2	15.6	13
18.5	25	38	32	27	23	19	17	15
22	30	45	38	32	27	23	20	18
30	40	60	51	42	36	30	27	24
37	50	75	64	53	45	38	34	30
45	60	90	77	63	54	45	41	36
55	75	110	94	77	–	–	–	–
75	100	145	123	102	–	–	–	–
90	125	178	151	125	–	–	–	–

#### Ambient temperature

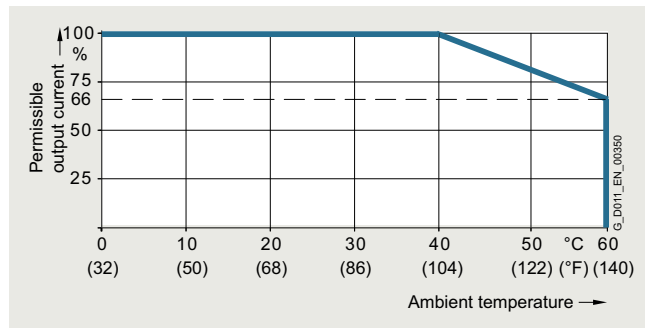

Permissible output current as a function of ambient temperature for low overload (LO) for PM250 Power Modules, frame sizes FSC to FSF

The operating temperature ranges of the Control Units should be taken into account. The temperature ranges are specified in the section [Technical specifications under Control Units](#).

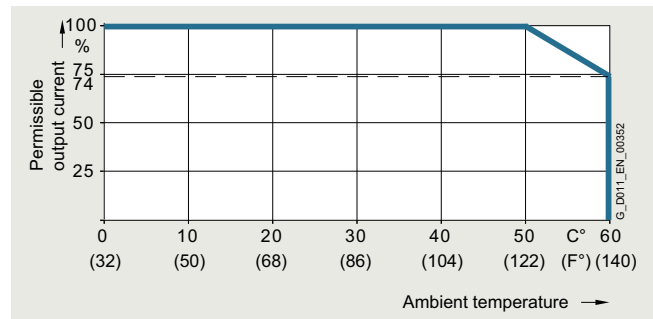

Permissible output current as a function of ambient temperature for high overload (HO) for PM250 Power Modules, frame sizes FSC to FSF

# SINAMICS G120 standard converters

0.37 kW to 250 kW (0.5 hp to 400 hp)

## Power Modules

### Characteristic curves

#### Derating data, PM250 Power Modules (continued)

##### Installation altitude

Permissible line supplies as a function of the installation altitude

- Installation altitude up to 2000 m (6562 ft) above sea level
  - Connection to every supply system permitted for the converter
- Installation altitudes between 2000 m (6562 ft) and 4000 m (13124 ft) above sea level
  - Connection only to a TN system with grounded neutral point
  - TN systems with grounded line conductor are not permitted
  - The TN line system with grounded neutral point can also be supplied using an isolation transformer
  - The phase against phase voltage does not have to be reduced

The connected motors, power elements and components must be considered separately.

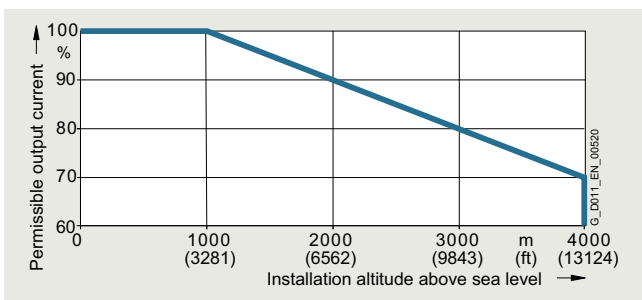

Permissible output current as a function of the installation altitude for PM250 Power Modules, frame sizes FSC to FSF

##### System operating voltage

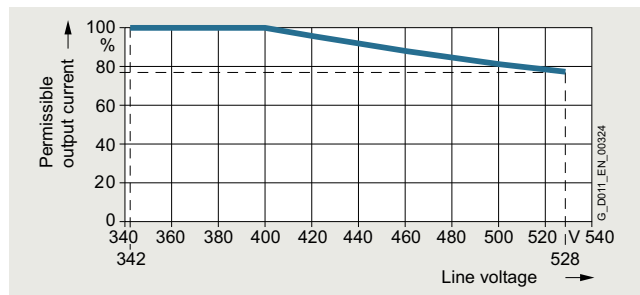

Permissible output current as a function of the line voltage for PM250 Power Modules, frame sizes FSC to FSF

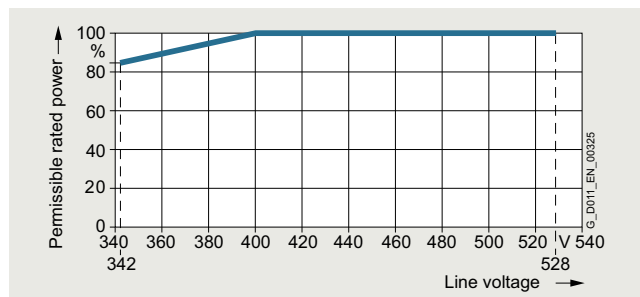

Permissible rated power as a function of the line voltage for PM250 Power Modules, frame sizes FSC to FSF

More information on the derating data of the PM250 Power Modules is available in the Hardware Installation Manual on the internet at:

[www.siemens.com/sinamics-g120/documentation](http://www.siemens.com/sinamics-g120/documentation)

## Dimensional drawings

### PM240-2 Power Modules, standard variant

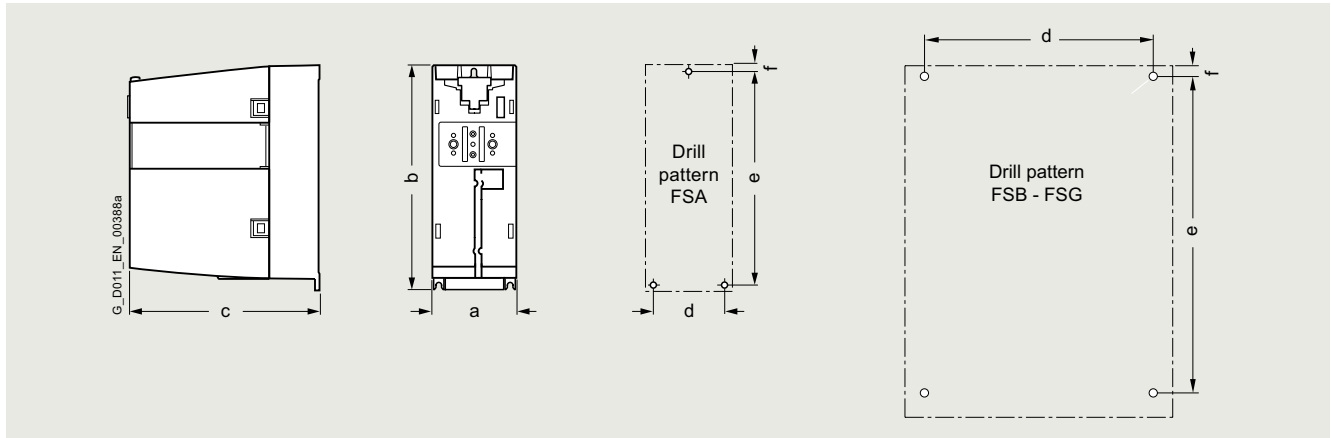

Principle dimension drawing and drill pattern for PM240-2 Power Modules, standard variant, with/without integrated line filter

Frame size	Dimensions in mm (inches)			Drilling dimensions in mm (inches)			Cooling clearance <sup>2)</sup> in mm (inches)			Mounting With bolts
	a (width)	b (height)	c (depth) <sup>1)</sup>	d	e	f	top	bottom	front	
<b>PM240-2 Power Modules, standard variant, with/without integrated line filter</b>										
FSA	73 (2.87)	196 (7.72)	165 (6.5)	62.3 (2.45)	186 (7.32)	6 (0.24)	80 (3.15)	100 (3.94)	0 (0)	3 × M4
FSB	100 (3.94)	292 (11.5)	165 (6.5)	80 (3.15)	281 (11.06)	6 (0.24)	80 (3.15)	100 (3.94)	0 (0)	4 × M4
FSC	140 (5.51)	355 (13.98)	165 (6.5)	120 (4.72)	343 (13.5)	6 (0.24)	80 (3.15)	100 (3.94)	0 (0)	4 × M5
FSD	200 (7.87)	472 (18.58)	237 (9.33)	170 (6.69)	430 (16.93)	7 (0.28)	300 (11.81)	350 (13.78)	100 (3.94)	4 × M5
FSE	275 (10.83)	551 (21.69)	237 (9.33)	230 (9.06)	509 (20.04)	8.5 (0.33)	300 (11.81)	350 (13.78)	100 (3.94)	4 × M6
FSF	305 (12.01)	708 (27.87)	357 (14.06)	270 (10.63)	680 (26.77)	13 (0.51)	300 (11.81)	350 (13.78)	100 (3.94)	4 × M8
FSG	305 (12.01)	1000 (39.37)	357 (14.06)	265 (10.43)	970.5 (38.21)	15 (0.59)	300 (11.81)	350 (13.78)	100 (3.94)	4 × M10

<sup>1)</sup> Increased depth:

- When the CU230P-2 Control Unit is plugged on, the depth increases by
  - 58 mm (2.28 in) for frame sizes FSA to FSC
  - 16 mm (0.63 in) for PM240-2, frame sizes FSD to FSG
- When the CU240E-2 Control Unit is plugged on, the depth increases by
  - 41 mm (1.61 in) for frame sizes FSA to FSC
  - 0 mm (0 in) for PM240-2, frame sizes FSD to FSG
- When the CU250S-2 Control Unit is plugged in, the depth increases by
  - 62 mm (2.44 in) for frame sizes FSA to FSC
  - 19 mm (0.75 in) for PM240-2, frame sizes FSD to FSG
- When the IOP-2/BOP-2 is plugged on, the depth increases by a further 11 mm (0.43 in)

<sup>2)</sup> The Power Modules can be mounted side by side. A side clearance of 1 mm (0.04 in) is recommended for tolerance-related reasons.

## SINAMICS G120 standard converters

0.37 kW to 250 kW (0.5 hp to 400 hp)

### Power Modules

#### Dimensional drawings

##### PM250 Power Modules – IP20 degree of protection

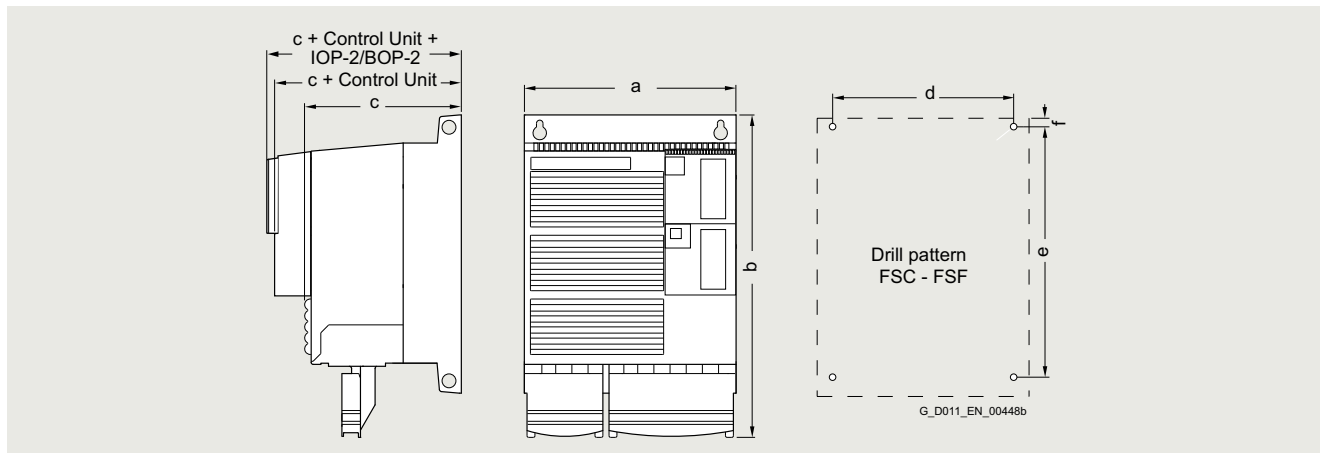

Principle dimension drawing and drill pattern for PM250 Power Modules, IP20 degree of protection, with/without integrated line filter class A

Frame size	Dimensions in mm (inches)			Drilling dimensions in mm (inches)			Cooling clearance in mm (inches)			Mounting
	a (width)	b (height)	c (depth) <sup>1)</sup>	d	e	f	top/bottom	side	front	
<b>PM250 Power Modules, IP20 degree of protection, with/without integrated line filter class A</b>										
FSC	189 (7.44)	334 (13.15)	185 (7.28)	167 (6.57)	323 (12.72)	6 (0.24)	125 (4.92)	50 (1.97) <sup>2)</sup>	0 (0)	4 × M5
FSD	275 (10.83)	419/512 (16.5/20.16)	204 (8.03)	235 (9.25)	325/419 (12.8/16.5)	11 (0.43)	300 (11.81)	0 (0)	0 (0)	4 × M8
FSE	275 (10.83)	499/635 (19.65/25)	204 (8.03)	235 (9.25)	405/541 (15.94/21.3)	11 (0.43)	300 (11.81)	0 (0)	0 (0)	4 × M8
FSF	350 (13.78)	634/934 (24.96/36.77)	316 (12.44)	300 (11.81)	598/899 (23.54/35.39)	11 (0.43)	350 (13.78)	0 (0)	0 (0)	4 × M8

<sup>1)</sup> Increased depth:

- When the CU230P-2 Control Unit is plugged on, the depth increases by
  - 58 mm (2.28 in) for frame size FSC
  - 49 mm (1.93 in) for frame sizes FSD to FSF
- When the CU240E-2 Control Unit is plugged on, the depth increases by
  - 40 mm (1.57 in) for frame size FSC
  - 31 mm (1.22 in) for frame sizes FSD to FSF
- When the CU250S-2 Control Unit is plugged in, the depth increases by
  - 61 mm (2.4 in) for frame size FSC
  - 52 mm (2.05 in) for frame sizes FSD to FSF
- When the IOP-2/BOP-2 is plugged on, the depth increases by a further 12 mm (0.47 in)

<sup>2)</sup> Up to 40 °C (104 °F) without any lateral clearance.

## SINAMICS G120 standard converters

0.37 kW to 250 kW (0.5 hp to 400 hp)

Line-side components > Line filters

### Overview

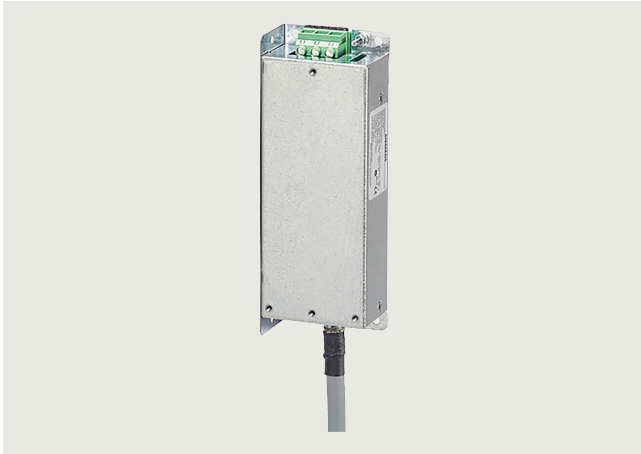

Line filters for PM240-2 Power Modules, frame size FSA

With one of the additional line filters, the Power Module reaches a higher radio interference class.

### Integration

PM250 Power Modules, frame size FSC, are available only with integrated line filter class A. To achieve class B, these Power Modules must be additionally fitted with a base filter class B.

#### Line filters that are optionally available depending on the Power Module used

	Frame size						
	FSA	FSB	FSC	FSD	FSE	FSF	FSG
<b>PM240-2 Power Module with integrated braking chopper</b>							
• 200 V versions	✓	✓	✓	✓ <sup>1)</sup>	✓ <sup>1)</sup>	✓ <sup>1)</sup>	–
• 400 V versions	✓	✓	✓	✓	✓	✓	✓
• 690 V versions	–	–	–	✓	✓	✓	✓
<b>Line-side components</b>							
Line filter class A	<b>F</b>	<b>F</b>	<b>F</b>	<b>F</b> <sup>1)</sup>	<b>F</b> <sup>1)</sup>	<b>F</b> <sup>1)</sup>	–
Line filter class B (only for 400 V versions)	<b>U</b>	<b>U</b>	<b>U</b>	–	–	–	–
Line filters of Category C2 or C3 (for 400 V versions frame size FSG)	–	–	–	–	–	–	<b>I</b> <sup>2)</sup>
Line filters of Category C3 (for 690 V versions frame size FSG)	–	–	–	–	–	–	<b>I</b> <sup>2)</sup>
<b>PM250 Power Module with line-commutated energy recovery</b>							
• 400 V versions	–	–	✓	✓	✓	✓	–
<b>Line-side components</b>							
Line filter class A	–	–	<b>I</b>	<b>F</b>	<b>F</b>	<b>F</b>	–
Line filter class B	–	–	<b>U</b>	–	–	–	–

U = Base component

S = Lateral mounting

I = Integrated

F = Power Modules available with and without integrated filter class A

– = Not possible

<sup>1)</sup> PM240-2 200 V versions, frame sizes FSD to FSF are only available without integrated line filter.

<sup>2)</sup> The PM240-2 Power Modules frame size FSG with an integrated Category C3 filter can also be operated on TN systems with a grounded line conductor. To do so, the grounding screw must be removed. Then Category C3 can no longer be adhered to.

**SINAMICS G120 standard converters**

0.37 kW to 250 kW (0.5 hp to 400 hp)

Line-side components &gt; Line filters

**Selection and ordering data**

Rated power		<b>PM240-2 Power Module</b>		<b>Line filter class B according to EN 55011</b>
kW	hp	Standard variant	Frame size	Article No.
<b>380 ... 480 V 3 AC</b>				
0.55	0.75	1PE11-8UL1	FSA	<b>6SL3203-0BE17-7BA0</b>
0.75	1	1PE12-3UL1		
1.1	1.5	1PE13-2UL1		
1.5	2	1PE14-3UL1		
2.2	3	1PE16-1UL1		
3	4	1PE18-0UL1		
4	5	1PE21-1UL0	FSB	<b>6SL3203-0BE21-8BA0</b>
5.5	7.5	1PE21-4UL0		
7.5	10	1PE21-8UL0		
11	15	1PE22-7UL0	FSC	<b>6SL3203-0BE23-8BA0</b>
15	20	1PE23-3UL0		
Rated power		<b>PM250 Power Module</b>		<b>Line filter class B according to EN 55011</b>
kW	hp	Standard variant	Frame size	Article No.
<b>380 ... 480 V 3 AC</b>				
7.5	10	0BE25-5AA1	FSC	<b>6SL3203-0BD23-8SA0</b>
11	15	0BE27-5AA1		
15	20	0BE31-1AA1		



## SINAMICS G120 standard converters

0.37 kW to 250 kW (0.5 hp to 400 hp)

Line-side components > Line filters

### Technical specifications

Line voltage 380 ... 480 V 3 AC		Line filter class B		
		6SL3203-OBE17-7BA0	6SL3203-OBE21-8BA0	6SL3203-OBE23-8BA0
<b>Rated current</b>	A	11.4	23.5	49.4
<b>Pulse frequency</b>	kHz	4 ... 16	4 ... 16	4 ... 16
<b>Line supply connection</b> L1, L2, L3		Screw terminals	Screw terminals	Screw terminals
• Conductor cross-section	mm <sup>2</sup>	1 ... 2.5	2.5 ... 6	6 ... 16
<b>Load connection</b> U, V, W		Shielded cable	Shielded cable	Shielded cable
• Cable cross-section	mm <sup>2</sup>	1.5	4	10
• Length	m (ft)	0.45 (1.48)	0.5 (1.64)	0.54 (1.77)
<b>PE connection</b>		On housing via M5 screw stud	On housing via M5 screw stud	On housing via M6 screw studs
• Conductor cross-section	mm <sup>2</sup>	1 ... 2.5	2.5 ... 6	6 ... 16
<b>Degree of protection</b>		IP20	IP20	IP20
<b>Dimensions</b>				
• Width	mm (in)	73 (2.87)	100 (3.94)	140 (5.51)
• Height	mm (in)	202 (7.95)	297 (11.7)	359 (14.1)
• Depth	mm (in)	65 (2.56)	85 (3.35)	95 (3.74)
<b>Possible as base component</b>		Yes	Yes	Yes
<b>Weight, approx.</b>	kg (lb)	1.75 (3.86)	4 (8.82)	7.3 (16.1)
<b>Suitable for PM240-2 Power Module standard variant 380 ... 480 V 3 AC</b>	Type	6SL3210-1PE11-8UL1 6SL3210-1PE12-3UL1 6SL3210-1PE13-2UL1 6SL3210-1PE14-3UL1 6SL3210-1PE16-1UL1 6SL3210-1PE18-0UL1	6SL3210-1PE21-1UL0 6SL3210-1PE21-4UL0 6SL3210-1PE21-8UL0	6SL3210-1PE22-7UL0 6SL3210-1PE23-3UL0
• Frame size		FSA	FSB	FSC

Line voltage 380 ... 480 V 3 AC		Line filter class B		
		6SL3203-0BD23-8SA0		
<b>Rated current</b>	A	39.4		
<b>Line supply connection</b> L1, L2, L3		Screw-type terminals		
• Conductor cross-section	mm <sup>2</sup>	4		
<b>Load connection</b> U, V, W		Shielded cable		
• Conductor cross-section	mm <sup>2</sup>	3 × 4		
• Length	m (ft)	0.4 (1.31)		
<b>PE connection</b>		On housing via M4 screw stud		
<b>Degree of protection</b>		IP20		
<b>Dimensions</b>				
• Width	mm (in)	190 (7.48)		
• Height	mm (in)	362 (14.25)		
• Depth	mm (in)	55 (2.17)		
<b>Possible as base component</b>		Yes		
<b>Weight, approx.</b>	kg (lb)	2.3 (5.07)		
<b>Suitable for PM250 Power Module</b>	Type	6SL3225-0BE25-5AA1 6SL3225-0BE27-5AA1 6SL3225-0BE31-1AA1		
• Frame size		FSC		

## SINAMICS G120 standard converters

0.37 kW to 250 kW (0.5 hp to 400 hp)

### Line-side components > Line Harmonics Filter

#### Overview

Using a Line Harmonics Filter (only for PM240-2 Power Modules, frame sizes FSD to FSG) makes for a substantial reduction in unwanted harmonics. In this way, a THD(I) value less than 5 % can be achieved and observance of the limit values according to IEC 61000-3-12, IEC 61000-2-2 and IEEE 519 is possible independently of the line impedance.

A line reactor is not required for a Line Harmonics Filter.

The permissible line voltage is 380 V to 415 V 3 AC.

For Line Harmonics Filters for higher line voltages up to 480 V see: [www.schaffner.com](http://www.schaffner.com)

#### Integration

##### Line Harmonics Filters that are optionally available depending on the Power Module used

	Frame size						
	FSA	FSB	FSC	FSD	FSE	FSF	FSG
<b>PM240-2 Power Module with integrated braking chopper</b>							
• 200 V versions	✓	✓	✓	✓	✓	✓	–
• 400 V versions	✓	✓	✓	✓	✓	✓	✓
• 690 V versions	–	–	–	✓	✓	✓	✓
<b>Line-side components</b>							
Line Harmonics Filters (only for 400 V versions)	–	–	–	S	S	S	S

S = Lateral mounting

– = Not possible

## SINAMICS G120 standard converters

0.37 kW to 250 kW (0.5 hp to 400 hp)

Line-side components > Line Harmonics Filter

### Selection and ordering data

Rated power		PM240-2 Power Module Standard variant		Line Harmonics Filters
kW	hp	Type 6SL3210-...	Frame size	(The prefix "UAC:" is part of a Siemens internal order code, which does not belong to the product number of the original equipment manufacturer Schaffner EMV AG) Article No.
<b>380 ... 480 V 3 AC</b>				
18.5	25	1PE23-8 . L0	FSD	<b>UAC:FN344019113E2FAJRX</b>
22	30	1PE24-5 . L0		<b>UAC:FN344022115E2FAJRX</b>
30	40	1PE26-0 . L0		<b>UAC:FN344030115E2FAJRX</b>
37	50	1PE27-5 . L0		<b>UAC:FN344037115E2FAJRX</b>
45	60	1PE28-8 . L0	FSE	<b>UAC:FN344045115E2FAJRX</b>
55	75	1PE31-1 . L0		<b>UAC:FN344055115E2FAJRX</b>
75	100	1PE31-5 . L0	FSF	<b>UAC:FN344075116E2FAJRX</b>
90	125	1PE31-8 . L0		<b>UAC:FN344090116E2FAJRX</b>
110	150	1PE32-1 . L0		<b>UAC:FN3440110118E2FAJRX</b>
132	200	1PE32-5 . L0		<b>UAC:FN3440132118E2FAJXX</b>
160 <sup>1)</sup>	250	1PE33-0 . L0	FSG	<b>UAC:FN3440160118E2FAJXX</b>
200 <sup>1)</sup>	300	1PE33-7 . L0		<b>UAC:FN3440200118E2FAJXX</b>
250 <sup>1) 2)</sup>	400	1PE34-8 . L0		<b>UAC:FN3440132118E2FAJXX</b>

#### Note:

The permissible line voltage is 380 V to 415 V 3 AC. For Line Harmonics Filters for higher line voltages up to 480 V see: [www.schaffner.com](http://www.schaffner.com)

<sup>1)</sup> 160 kW to 250 kW Power Modules with Line Harmonics Filters can only be operated with Vector control. U/f control is not permitted.

<sup>2)</sup> Two Line Harmonics Filters must be ordered for 250 kW, which must be connected in parallel.

## SINAMICS G120 standard converters

0.37 kW to 250 kW (0.5 hp to 400 hp)

### Line-side components > Line Harmonics Filter

#### Technical specifications

Line voltage 380 ... 480 V 3 AC <sup>1)</sup>		Line Harmonics Filters			
		UAC: FN344019113E2FAJRX	UAC: FN344022115E2FAJRX	UAC: FN344030115E2FAJRX	UAC: FN344037115E2FAJRX
<b>Rated current</b>	A	28.2	32.5	44.4	54.8
<b>Line supply connection</b> L1, L2, L3		Threaded screw M6	Threaded screw M8	Threaded screw M8	Threaded screw M8
<b>Load connection</b> L1', L2', L3'		Threaded screw M6	Threaded screw M8	Threaded screw M8	Threaded screw M8
<b>PE connection</b>		Threaded bolt M8	Threaded bolt M8	Threaded bolt M8	Threaded bolt M8
<b>Degree of protection</b>		IP20	IP20	IP20	IP20
<b>Dimensions</b>					
• Width	mm (in)	260 (10.24)	290 (11.42)	290 (11.42)	290 (11.42)
• Height	mm (in)	560 (22.05)	705 (27.76)	705 (27.76)	705 (27.76)
• Depth	mm (in)	252 (9.92)	319 (12.56)	319 (12.56)	319 (12.56)
<b>Possible as base component</b>		No	No	No	No
<b>Weight, approx.</b>	kg (lb)	37 (81.6)	53 (117)	55 (121)	66 (146)
<b>Suitable for PM240-2 Power Module standard variant 380 ... 480 V 3 AC</b>	Type	6SL3210-1PE23-8 . L0	6SL3210-1PE24-5 . L0	6SL3210-1PE26-0 . L0	6SL3210-1PE27-5 . L0
• Frame size		FSD	FSD	FSD	FSD

Line voltage 380 ... 480 V 3 AC <sup>1)</sup>		Line Harmonics Filters			
		UAC: FN344045115E2FAJRX	UAC: FN344055115E2FAJRX	UAC: FN344075116E2FAJRX	UAC: FN344090116E2FAJRX
<b>Rated current</b>	A	66.7	81.6	111	134
<b>Line supply connection</b> L1, L2, L3		Threaded screw M8	Threaded screw M8	Threaded screw M8	Threaded screw M8
<b>Load connection</b> L1', L2', L3'		Threaded screw M8	Threaded screw M8	Threaded screw M8	Threaded screw M8
<b>PE connection</b>		Threaded bolt M8	Threaded bolt M8	Threaded bolt M10	Threaded bolt M10
<b>Degree of protection</b>		IP20	IP20	IP20	IP20
<b>Dimensions</b>					
• Width	mm (in)	290 (11.42)	290 (11.42)	353 (13.90)	353 (13.90)
• Height	mm (in)	705 (27.76)	705 (27.76)	960 (37.80)	960 (37.80)
• Depth	mm (in)	319 (12.56)	319 (12.56)	386 (15.20)	386 (15.20)
<b>Possible as base component</b>		No	No	No	No
<b>Weight, approx.</b>	kg (lb)	73 (161)	75 (165)	126 (278)	147 (324)
<b>Suitable for PM240-2 Power Module standard variant 380 ... 480 V 3 AC</b>	Type	6SL3210-1PE28-8 . L0	6SL3210-1PE31-1 . L0	6SL3210-1PE31-5 . L0	6SL3210-1PE31-8 . L0
• Frame size		FSE	FSE	FSF	FSF

<sup>1)</sup> The permissible line voltage amounts to 380 V to 415 V 3 AC.  
For Line Harmonics Filters for higher line voltages up to 480 V see:  
[www.schaffner.com](http://www.schaffner.com)

## SINAMICS G120 standard converters

0.37 kW to 250 kW (0.5 hp to 400 hp)

### Line-side components > Line Harmonics Filter

#### Technical specifications

Line voltage 380 ... 480 V 3 AC <sup>1)</sup>		Line Harmonics Filters			
		UAC: FN3440110118E2FAJRX	UAC: FN3440132118E2FAJXX	UAC: FN3440160118E2FAJXX	UAC: FN3440200118E2FAJXX
<b>Rated current</b>	A	164	197	240	300
<b>Line supply connection</b> L1, L2, L3		Threaded screw M10	Threaded screw M10	Threaded screw M10	Threaded screw M10
<b>Load connection</b> L1', L2', L3'		Threaded screw M10	Threaded screw M10	Threaded screw M10	Threaded screw M10
<b>PE connection</b>		Threaded bolt M10	Threaded bolt M10	Threaded bolt M10	Threaded bolt M10
<b>Degree of protection</b>		IP20	IP20	IP20	IP20
<b>Dimensions</b>					
• Width	mm (in)	462 (18.19)	462 (18.19)	462 (18.19)	462 (18.19)
• Height	mm (in)	1150 (45.28)	1150 (45.28)	1150 (45.28)	1150 (45.28)
• Depth	mm (in)	456 (17.95)	456 (17.95)	456 (17.95)	456 (17.95)
<b>Possible as base component</b>		No	No	No	No
<b>Weight, approx.</b>	kg (lb)	175 (386)	194 (428)	219 (483)	267 (589)
<b>Suitable for PM240-2 Power Module standard variant 380 ... 480 V 3 AC</b>	Type	6SL3210-1PE32-1 . L0	6SL3210-1PE32-5 . L0 6SL3210-1PE34-8 . L0 (for 250 kW (FSG) two Line Harmonics Filters must be connected in parallel)	6SL3210-1PE33-0 . L0	6SL3210-1PE33-7 . L0
• Frame size		FSF	FSF/FSG	FSG	FSG

<sup>1)</sup> The permissible line voltage amounts to 380 V to 415 V 3 AC.  
For Line Harmonics Filters for higher line voltages up to 480 V see:  
[www.schaffner.com](http://www.schaffner.com)

## SINAMICS G120 standard converters

0.37 kW to 250 kW (0.5 hp to 400 hp)

### Line-side components > Line reactors

#### Overview

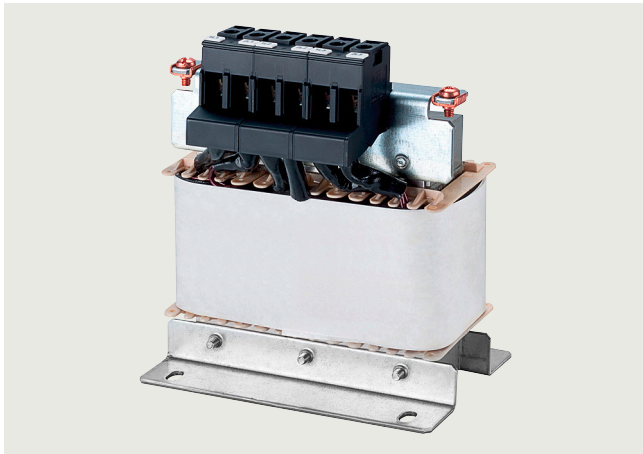

Line reactor for PM240-2 Power Modules, frame size FSA

Line reactors smooth the current drawn by the converter and thus reduce harmonic components in the line current. Through the reduction of the current harmonics, the thermal load on the power components in the rectifier and in the DC link capacitors is reduced as well as the harmonic effects on the supply. The use of a line reactor increases the service life of the converter.

A line reactor is not required and must not be used in conjunction with a PM250 Power Module.

#### Integration

A DC link reactor is integrated in the PM240-2 Power Modules, frame sizes FSD to FSG, and therefore no line reactor is required.

#### Line reactors that are optionally available depending on the Power Module used

	Frame size						
	FSA	FSB	FSC	FSD	FSE	FSF	FSG
<b>PM240-2 Power Module with integrated braking chopper</b>							
• 200 V versions	✓	✓	✓	✓	✓	✓	–
• 400 V versions	✓	✓	✓	✓	✓	✓	✓
• 690 V versions	–	–	–	✓	✓	✓	✓
<b>Line-side components</b>							
Line reactors (only for 3 AC versions <sup>1)</sup> )	S <sup>2)</sup>	S <sup>2)</sup>	S <sup>2)</sup>	I	I	I	I

S = Lateral mounting

I = Integrated

– = Not possible

<sup>1)</sup> With the appropriate wiring, the line reactors for 200 V 3 AC can be used for the 200 V versions for 200 V 1 AC. More information can be found on the internet at:  
<https://support.industry.siemens.com/cs/document/109486005>  
<https://support.industry.siemens.com/cs/document/109482011>

<sup>2)</sup> For frame sizes FSA to FSC, for lines with  $u_k < 1\%$ , it is recommended that you use a line reactor or the next more powerful Power Module. More information can be found on the internet at:  
<https://support.industry.siemens.com/cs/document/109482011>

## SINAMICS G120 standard converters

0.37 kW to 250 kW (0.5 hp to 400 hp)

Line-side components > Line reactors

### Selection and ordering data

Rated power		PM240-2 Power Module	Line reactor
kW	hp	Standard variant	Article No.
		Type 6SL3210-...	
		Frame size	
<b>200 ... 240 V 3 AC <sup>1)</sup></b>			
0.55	0.75	1PB13-0 . L0	<b>6SL3203-OCE13-2AA0</b>
0.75	1	1PB13-8 . L0	
1.1	1.5	1PB15-5 . L0	<b>6SL3203-OCE21-0AA0</b>
1.5	2	1PB17-4 . L0	
2.2	3	1PB21-0 . L0	<b>6SL3203-OCE21-8AA0</b>
3	4	1PB21-4 . L0	
4	5	1PB21-8 . L0	<b>6SL3203-OCE23-8AA0</b>
5.5	7.5	1PC22-2 . L0	
7.5	10	1PC22-8 . L0	
<b>380 ... 480 V 3 AC</b>			
0.55	0.75	1PE11-8 . L1	<b>6SL3203-OCE13-2AA0</b>
0.75	1	1PE12-3 . L1	
1.1	1.5	1PE13-2 . L1	<b>6SL3203-OCE21-0AA0</b>
1.5	2	1PE14-3 . L1	
2.2	3	1PE16-1 . L1	<b>6SL3203-OCE21-8AA0</b>
3	4	1PE18-0 . L1	
4	5	1PE21-1 . L0	<b>6SL3203-OCE21-8AA0</b>
5.5	7.5	1PE21-4 . L0	
7.5	10	1PE21-8 . L0	<b>6SL3203-OCE23-8AA0</b>
11	15	1PE22-7 . L0	
15	20	1PE23-3 . L0	

<sup>1)</sup> With the appropriate wiring, the line reactors for 200 V 3 AC can be used for the 200 V versions for 200 V 1 AC. More information can be found on the internet at:  
<https://support.industry.siemens.com/cs/document/109486005>  
<https://support.industry.siemens.com/cs/document/109482011>

## SINAMICS G120 standard converters

0.37 kW to 250 kW (0.5 hp to 400 hp)

### Line-side components > Line reactors

#### Technical specifications

Line voltage 200 ... 240 V 3 AC <sup>1)</sup> or 380 ... 480 V 3 AC		Line reactor			
		6SL3203-OCE13-2AA0	6SL3203-OCE21-0AA0	6SL3203-OCE21-8AA0	6SL3203-OCE23-8AA0
<b>Rated current</b>	A	4	11.3	22.3	47
<b>Power loss</b> at 50/60 Hz	W	23/26	36/40	53/59	88/97
<b>Line supply/load connection</b> 1L1, 1L2, 1L3 2L1, 2L2, 2L3		Screw terminals	Screw terminals	Screw terminals	Screw terminals
• Conductor cross-section	mm <sup>2</sup>	4	4	10	16
<b>PE connection</b>		M4 × 8; U washer; spring lock washer	M4 × 8; U washer; spring lock washer	M5 × 10; U washer; spring lock washer	M5 × 10; U washer; spring lock washer
<b>Degree of protection</b>		IP20	IP20	IP20	IP20
<b>Dimensions</b>					
• Width	mm (in)	125 (4.92)	125 (4.92)	125 (4.92)	190 (7.48)
• Height	mm (in)	120 (4.72)	140 (5.51)	145 (5.71)	220 (8.66)
• Depth	mm (in)	71 (2.8)	71 (2.8)	91 (3.58)	91 (3.58)
<b>Weight, approx.</b>	kg (lb)	1.1 (2.43)	2.1 (4.63)	2.95 (6.5)	7.8 (17.2)
<b>Suitable for PM240-2 Power Module standard variant 200 ... 240 V 3 AC <sup>1)</sup></b>	Type	6SL3210-1PB13-0 . L0 6SL3210-1PB13-8 . L0	6SL3210-1PB15-5 . L0 6SL3210-1PB17-4 . L0 6SL3210-1PB21-0 . L0	6SL3210-1PB21-4 . L0 6SL3210-1PB21-8 . L0	6SL3210-1PC22-2 . L0 6SL3210-1PC22-8 . L0
• Frame size		FSA	FSB	FSC	FSC
<b>Suitable for PM240-2 Power Module standard variant 380 ... 480 V 3 AC</b>	Type	6SL3210-1PE11-8 . L1 6SL3210-1PE12-3 . L1 6SL3210-1PE13-2 . L1	6SL3210-1PE14-3 . L1 6SL3210-1PE16-1 . L1 6SL3210-1PE18-0 . L1	6SL3210-1PE21-1 . L0 6SL3210-1PE21-4 . L0 6SL3210-1PE21-8 . L0	6SL3210-1PE22-7 . L0 6SL3210-1PE23-3 . L0
• Frame size		FSA	FSA	FSB	FSC

<sup>1)</sup> With the appropriate wiring, the line reactors for 200 V 3 AC can be used for the 200 V versions for 200 V 1 AC. Further information can be found on the internet at:  
<https://support.industry.siemens.com/cs/document/109486005>  
<https://support.industry.siemens.com/cs/document/109482011>



## SINAMICS G120 standard converters

0.37 kW to 250 kW (0.5 hp to 400 hp)

### Line-side components > Recommended line-side overcurrent protection devices

#### Selection and ordering data

##### Recommended line-side overcurrent protection devices for PM240-2 Power Modules

Overcurrent protection devices are absolutely necessary for the operation of the converters. The following tables list recommendations for fuses.

- Siemens fuses of type 3NA3 and 3NE1 for use in the area of validity of IEC
- UL-listed fuses Class J or Siemens 3NE1 fuses for use in the USA and Canada

Recommendations on further overcurrent protection devices are available at:

<https://support.industry.siemens.com/cs/document/109486009>

The Short-Circuit Current Rating (SCCR) according to UL for industrial control panel installations to NEC Article 409 or UL 508A/508C or UL 61800-5-1 is as follows for Class J fuses for

- PM240-2 Power Modules for SINAMICS G120: 100 kA

SCCR and ICC values for combination with further overcurrent protection devices are available at:

<https://support.industry.siemens.com/cs/document/109486009>

Notes for installations in Canada:

The converters are intended for line supply systems with overvoltage category III. Additional information is available in the technical documentation on the internet at:

[www.siemens.com/sinamics-g120/documentation](http://www.siemens.com/sinamics-g120/documentation)

Additional information about the listed Siemens fuses is available in Catalog LV 10 as well as in the Industry Mall.

Rated power <sup>1)</sup>		PM240-2 Power Module Standard variant		IEC-compliant Fuse		UL/cUL-compliant Fuse type Rated voltage 600 V AC	
kW	hp	Type 6SL3210-...	Frame size	Current A	Article No.	Class	Current A
<b>200 ... 240 V 1 AC/3 AC</b>							
0.55	0.75	1PB13-0 . LO	FSA	16	<b>3NA3805</b>	J	15
0.75	1	1PB13-8 . LO	FSA	16	<b>3NA3805</b>	J	15
1.1	1.5	1PB15-5 . LO	FSB	32	<b>3NA3812</b>	J	35
1.5	2	1PB17-4 . LO	FSB	32	<b>3NA3812</b>	J	35
2.2	3	1PB21-0 . LO	FSB	32	<b>3NA3812</b>	J	35
3	4	1PB21-4 . LO	FSC	50	<b>3NA3820</b>	J	50
4	5	1PB21-8 . LO	FSC	50	<b>3NA3820</b>	J	50
<b>200 ... 240 V 3 AC</b>							
5.5	7.5	1PC22-2 . LO	FSC	50	<b>3NA3820</b>	J	50
7.5	10	1PC22-8 . LO	FSC	50	<b>3NA3820</b>	J	50
11	15	1PC24-2UL0	FSD	63	<b>3NA3822</b>	J	60
15	20	1PC25-4UL0	FSD	80	<b>3NA3824</b>	J	70
18.5	25	1PC26-8UL0	FSD	100	<b>3NA3830</b>	J	90
22	30	1PC28-0UL0	FSE	100	<b>3NA3830</b>	J	100
30	40	1PC31-1UL0	FSE	160	<b>3NA3836</b>	J	150
37	50	1PC31-3UL0	FSF	200	<b>3NA3140</b>	J	175
45	60	1PC31-6UL0	FSF	200	<b>3NA3140</b>	J	200
55	75	1PC31-8UL0	FSF	224	<b>3NA3142</b>	J	250

<sup>1)</sup> Rated power based on the rated output current  $I_N$ . The rated output current  $I_N$  is based on the duty cycle for low overload (LO).

## SINAMICS G120 standard converters

0.37 kW to 250 kW (0.5 hp to 400 hp)

Line-side components > Recommended line-side overcurrent protection devices

### Selection and ordering data

Rated power <sup>1)</sup>		PM240-2 Power Module		IEC-compliant		UL/cUL-compliant	
		Standard variant		Fuse		Fuse type	
		Type	Frame size	Current	Article No.	Rated voltage 600 V AC	Current
kW	hp	6SL3210-...		A		Class	A
<b>380 ... 480 V 3 AC</b>							
0.55	0.75	1PE11-8 . L1	FSA	10	<b>3NA3803</b>	J	10
0.75	1	1PE12-3 . L1	FSA	10	<b>3NA3803</b>	J	10
1.1	1.5	1PE13-2 . L1	FSA	16	<b>3NA3805</b>	J	15
1.5	2	1PE14-3 . L1	FSA	16	<b>3NA3805</b>	J	15
2.2	3	1PE16-1 . L1	FSA	16	<b>3NA3805</b>	J	15
3	4	1PE18-0 . L1	FSA	16	<b>3NA3805</b>	J	15
4	5	1PE21-1 . LO	FSB	32	<b>3NA3812</b>	J	35
5.5	7.5	1PE21-4 . LO	FSB	32	<b>3NA3812</b>	J	35
7.5	10	1PE21-8 . LO	FSB	32	<b>3NA3812</b>	J	35
11	15	1PE22-7 . LO	FSC	50	<b>3NA3820</b>	J	50
15	20	1PE23-3 . LO	FSC	50	<b>3NA3820</b>	J	50
18.5	25	1PE23-8 . LO	FSD	63	<b>3NA3822</b>	J	60
22	30	1PE24-5 . LO	FSD	80	<b>3NA3824</b>	J	70
30	40	1PE26-0 . LO	FSD	100	<b>3NA3830</b>	J	90
37	50	1PE27-5 . LO	FSD	100	<b>3NA3830</b>	J	100
45	60	1PE28-8 . LO	FSE	125	<b>3NA3832</b>	J	125
55	75	1PE31-1 . LO	FSE	160	<b>3NA3836</b>	J	150
75	100	1PE31-5 . LO	FSF	200	<b>3NA3140</b>	J	200
90	125	1PE31-8 . LO	FSF	224	<b>3NA3142</b>	J	250
110	150	1PE32-1 . LO	FSF	300	<b>3NA3250</b>	J	300
132	200	1PE32-5 . LO	FSF	315	<b>3NA3252</b>	J	350
160	250	1PE33-0 . LO	FSG	355	<b>3NA3254</b>	J	400
200	300	1PE33-7 . LO	FSG	400	<b>3NA3260</b>	J	500
250	400	1PE34-8 . LO	FSG	630	<b>3NA3372</b>	J	600
<b>500 ... 690 V 3 AC</b>							
11	10	1PH21-4 . LO	FSD	20	<b>3NA3807-6</b>	J	20
15	15	1PH22-0 . LO	FSD	25	<b>3NA3810-6</b>	J	25
18.5	20	1PH22-3 . LO	FSD	32	<b>3NA3812-6</b>	J	30
22	25	1PH22-7 . LO	FSD	40	<b>3NA3817-6KJ</b>	J	35
30	30	1PH23-5 . LO	FSD	50	<b>3NA3820-6KJ</b>	J	50
37	40	1PH24-2 . LO	FSD	63	<b>3NA3822-6</b>	J	60
45	50	1PH25-2 . LO	FSE	80	<b>3NA3824-6</b>	J	80
55	60	1PH26-2 . LO	FSE	80	<b>3NA3824-6</b>	J	80
75	75	1PH28-0 . LO	FSF	100	<b>3NA3830-6</b>	J	110
90	100	1PH31-0 . LO	FSF	125	<b>3NA3132-6</b>	J	150
110	100	1PH31-2 . LO	FSF	160	<b>3NA3136-6</b>	J	150
132	125	1PH31-4 . LO	FSF	200	<b>3NA3140-6</b>	J	200
				IEC and UL-compliant			
				Fuse		Fuse	
				Current	Article No.	Current	Article No.
				A		A	
160	150	1PH31-7CLO	FSG	250	<b>3NE1227-0</b>	250	<b>3NE1227-0</b>
200	200	1PH32-1CLO	FSG	315	<b>3NE1230-0</b>	315	<b>3NE1230-0</b>
250	250	1PH32-5CLO	FSG	355	<b>3NE1331-0</b>	355	<b>3NE1331-0</b>

<sup>1)</sup> Rated power based on the rated output current  $I_N$ . The rated output current  $I_N$  is based on the duty cycle for low overload (LO).

## SINAMICS G120 standard converters

0.37 kW to 250 kW (0.5 hp to 400 hp)

### Line-side components > Recommended line-side overcurrent protection devices

#### Selection and ordering data

##### Recommended line-side overcurrent protection devices for PM250 Power Modules

Overcurrent protection devices are absolutely necessary for the operation of the converters. The following tables list recommendations for fuses.

Siemens fuses of type 3NA3 and 3NE1 for use in the area of validity of IEC

UL-listed fuses Class J or Siemens 3NE1 fuses for use in the USA and Canada

Recommendations on further overcurrent protection devices are available at:

<https://support.industry.siemens.com/cs/document/109795389>

The Short-Circuit Current Rating (SCCR) according to UL for industrial control panel installations to NEC Article 409 or UL 508A/508C or UL 61800-5-1 is as follows for Class J fuses for

- PM250 Power Modules for SINAMICS G120: 65 kA

SCCR and ICC values for combination with further overcurrent protection devices are available at:

<https://support.industry.siemens.com/cs/document/109795389>

Notes for installations in Canada:

The converters are intended for line supply systems with over-voltage category III. Additional information is available in the technical documentation on the internet at:

[www.siemens.com/sinamics-g120/documentation](http://www.siemens.com/sinamics-g120/documentation)

Additional information about the listed Siemens fuses is available in Catalog LV 10 as well as in the Industry Mall.

Rated power <sup>1)</sup>		PM250 Power Module		IEC-compliant Fuse		UL/cUL-compliant Fuse type	
kW	hp	Type	Frame size	Current A	Type 3NA3 Article No.	Rated voltage 600 V AC Class	Current A
<b>380 ... 480 V 3 AC</b>							
7.5	10	OBE25-5AA1	FSC	50	<b>3NA3820</b>	J	50
11	15	OBE27-5AA1	FSC	50	<b>3NA3820</b>	J	50
15	20	OBE31-1AA1	FSC	50	<b>3NA3820</b>	J	50
18.5	25	OBE31-5 . A0	FSD	50	<b>3NA3820</b>	J	50
22	30	OBE31-8 . A0	FSD	63	<b>3NA3822</b>	J	63
30	40	OBE32-2 . A0	FSD	80	<b>3NA3824</b>	J	80
37	50	OBE33-0 . A0	FSE	100	<b>3NA3830</b>	J	100
45	60	OBE33-7 . A0	FSE	125	<b>3NA3832</b>	J	125
55	75	OBE34-5 . A0	FSF	160	<b>3NA3836</b>	J	160
75	100	OBE35-5 . A0	FSF	200	<b>3NA3140</b>	J	200
90	125	OBE37-5 . A0	FSF	250	<b>3NA3144</b>	J	250

<sup>1)</sup> Rated power based on the rated output current  $I_N$ . The rated output current  $I_N$  is based on the duty cycle for low overload (LO).

## SINAMICS G120 standard converters

0.37 kW to 250 kW (0.5 hp to 400 hp)

### DC link components > Braking resistors

#### Overview



Braking resistor for PM240-2 Power Modules, frame size FSD



Braking resistor for PM240-2 Power Modules, frame size FSG

Excess energy in the DC link is dissipated in the braking resistor. The braking resistors are intended for use with PM240-2 Power Modules which feature an integrated braking chopper, but cannot regenerate energy to the supply system. For regenerative operation, e.g. the braking of a rotating mass with high moment of inertia, a braking resistor must be connected to convert the resulting energy into heat.

The braking resistors can be installed laterally next to the PM240-2 Power Modules. The braking resistors for the Power Modules, frame sizes FSD to FSG, should be placed outside the control cabinet or outside the switchgear room so that the heat is dissipated away from the Power Modules. The level of air conditioning required is therefore reduced.

Every braking resistor has a temperature switch (UL-listed). The temperature switch should be evaluated to prevent consequential damage if the braking resistor overheats.

A PM250 Power Module is capable of line-commutated energy feedback. A braking resistor cannot be connected and is not necessary.

#### Note:

For the electromagnetically compatible connection of an optionally connectable braking resistor, the corresponding shield connection kit is to be ordered for frame sizes FSD to FSG.

For more information, see [shield connection kits in the section Supplementary system components](#).

9

#### Integration

##### Braking resistors that are optionally available depending on the Power Module used

	Frame size						
	FSA	FSB	FSC	FSD	FSE	FSF	FSG
<b>PM240-2 Power Module with integrated braking chopper</b>							
• 200 V versions	✓	✓	✓	✓	✓	✓	–
• 400 V versions	✓	✓	✓	✓	✓	✓	✓
• 690 V versions	–	–	–	✓	✓	✓	✓
<b>DC link components</b>							
Braking resistor	S	S	S	S	S	S	S

S = Lateral mounting

– = Not possible

## SINAMICS G120 standard converters

0.37 kW to 250 kW (0.5 hp to 400 hp)

DC link components > Braking resistors

### Selection and ordering data

Rated power		PM240-2 Power Module Standard variant		Braking resistor
kW	hp	Type 6SL3210-...	Frame size	(The prefix "JJY:" is part of a Siemens internal order code which does not belong to the product number of the original equipment manufacturer Heine Resistor GmbH) Article No.
<b>200 ... 240 V 1 AC/3 AC</b>				
0.55	0.75	1PB13-0 . L0	FSA	<b>JJY:023146720008</b>
0.75	1	1PB13-8 . L0		
1.1	1.5	1PB15-5 . L0	FSB	<b>JJY:023151720007</b>
1.5	2	1PB17-4 . L0		
2.2	3	1PB21-0 . L0		
3	4	1PB21-4 . L0	FSC	<b>JJY:023163720018</b>
4	5	1PB21-8 . L0		
<b>200 ... 240 V 3 AC</b>				
5.5	7.5	1PC22-2 . L0	FSC	<b>JJY:023433720001</b>
7.5	10	1PC22-8 . L0		
11	15	1PC24-2UL0	FSD	<b>JJY:023422620002</b>
15	20	1PC25-4UL0		
18.5	25	1PC26-8UL0		
22	30	1PC28-0UL0	FSE	<b>JJY:023423320001</b>
30	40	1PC31-1UL0		
37	50	1PC31-3UL0	FSF	<b>JJY:023434020003</b>
45	60	1PC31-6UL0		
55	75	1PC31-8UL0		
<b>380 ... 480 V 3 AC</b>				
0.55	0.75	1PE11-8 . L1	FSA	<b>6SL3201-0BE14-3AA0</b>
0.75	1	1PE12-3 . L1		
1.1	1.5	1PE13-2 . L1		
1.5	2	1PE14-3 . L1		
2.2	3	1PE16-1 . L1	FSA	<b>6SL3201-0BE21-0AA0</b>
3	4	1PE18-0 . L1		
4	5	1PE21-1 . L0	FSB	<b>6SL3201-0BE21-8AA0</b>
5.5	7.5	1PE21-4 . L0		
7.5	10	1PE21-8 . L0		
11	15	1PE22-7 . L0	FSC	<b>6SL3201-0BE23-8AA0</b>
15	20	1PE23-3 . L0		
18.5	25	1PE23-8 . L0	FSD	<b>JJY:023422620001</b>
22	30	1PE24-5 . L0		
30	40	1PE26-0 . L0	FSD	<b>JJY:023424020001</b>
37	50	1PE27-5 . L0		
45	60	1PE28-8 . L0	FSE	<b>JJY:023434020001</b>
55	75	1PE31-1 . L0		
75	100	1PE31-5 . L0	FSF	<b>JJY:023454020001</b>
90	125	1PE31-8 . L0		
110	150	1PE32-1 . L0	FSF	<b>JJY:023464020001</b>
132	200	1PE32-5 . L0		
160	250	1PE33-0 . L0	FSG	<b>6SL3000-1BE32-5AA0</b>
200	300	1PE33-7 . L0		
250	400	1PE34-8 . L0		

**SINAMICS G120 standard converters**

0.37 kW to 250 kW (0.5 hp to 400 hp)

DC link components &gt; Braking resistors

**Selection and ordering data**

Rated power		<b>PM240-2 Power Module</b>		<b>Braking resistor</b>
		<b>Standard variant</b>		(The prefix " <b>JJY:</b> " is part of a Siemens internal order code which does not belong to the product number of the original equipment manufacturer Heine Resistor GmbH)
kW	hp	Type 6SL3210-...	Frame size	Article No.
<b>500 ... 690 V 3 AC</b>				
11	10	1PH21-4 . LO	FSD	<b>JJY:023424020002</b>
15	15	1PH22-0 . LO		
18.5	20	1PH22-3 . LO		
22	25	1PH22-7 . LO		
30	30	1PH23-5 . LO		
37	40	1PH24-2 . LO		
45	50	1PH25-2 . LO	FSE	<b>JJY:023434020002</b>
55	60	1PH26-2 . LO		<b>JJY:023464020002</b>
75	75	1PH28-0 . LO	FSF	
90	100	1PH31-0 . LO		
110	100	1PH31-2 . LO		
132	125	1PH31-4 . LO		<b>6SL3000-1BH32-5AA0</b>
160	150	1PH31-7CLO	FSG	
200	200	1PH32-1CLO		
250	250	1PH32-5CLO		

## SINAMICS G120 standard converters

0.37 kW to 250 kW (0.5 hp to 400 hp)

DC link components > Braking resistors

### Technical specifications

Line voltage 200 ... 240 V 1 AC/3 AC		Braking resistor		
		JJY:023146720008	JJY:023151720007	JJY:023163720018
<b>Resistance</b>	Ω	200	68	37
<b>Rated power <math>P_{DB}</math></b> (Continuous braking power)	kW	0.0375	0.11	0.2
<b>Peak power <math>P_{max}</math></b> (load duration $t_a = 12$ s with period $t = 240$ s)	kW	0.75	2.2	4
<b>Power connection</b>		Cable	Cable	Cable
<b>Thermostatic switch</b>		Integrated	Integrated	Integrated
<b>Degree of protection</b>		IP20	IP20	IP20
<b>Dimensions</b>				
• Width	mm (in)	60 (2.36)	60 (2.36)	60 (2.36)
• Height	mm (in)	167 (6.57)	217 (8.54)	337 (13.27)
• Depth	mm (in)	30 (1.18)	30 (1.18)	30 (1.18)
<b>Weight, approx.</b>	kg (lb)	0.5 (1.10)	0.7 (1.54)	1.1 (2.43)
<b>Suitable for PM240-2 Power Module standard variant</b>	Type	6SL3210-1PB13-0 . L0 6SL3210-1PB13-8 . L0	6SL3210-1PB15-5 . L0 6SL3210-1PB17-4 . L0 6SL3210-1PB21-0 . L0	6SL3210-1PB21-4 . L0 6SL3210-1PB21-8 . L0
• Frame size		FSA	FSB	FSC

Line voltage 200 ... 240 V 3 AC		Braking resistor			
		JJY:023433720001	JJY:023422620002	JJY:023423320001	JJY:023434020003
<b>Resistance</b>	Ω	20	7.5	4.5	2.5
<b>Rated power <math>P_{DB}</math></b> (Continuous braking power)	kW	0.375	0.93	1.5	2.75
<b>Peak power <math>P_{max}</math></b> (load duration $t_a = 12$ s with period $t = 240$ s)	kW	7.5	18.5	30	55
<b>Power connection</b>		Cable	Cable	Cable	Cable
<b>Thermostatic switch</b>		Integrated	Integrated	Integrated	Integrated
<b>Degree of protection</b>		IP20	IP21	IP21	IP21
<b>Dimensions</b>					
• Width	mm (in)	337 (13.27)	220 (8.66)	220 (8.66)	350 (13.78)
• Height	mm (in)	120 (4.72)	470 (18.5)	560 (22.05)	630 (24.8)
• Depth	mm (in)	30 (1.18)	180 (7.09)	180 (7.09)	180 (7.09)
<b>Weight, approx.</b>	kg (lb)	2 (4.41)	7 (15.4)	8.5 (18.7)	13.5 (29.8)
<b>Suitable for PM240-2 Power Module standard variant</b>	Type	6SL3210-1PC22-2 . L0 6SL3210-1PC22-8 . L0	6SL3210-1PC24-2UL0 6SL3210-1PC25-4UL0 6SL3210-1PC26-8UL0	6SL3210-1PC28-0UL0 6SL3210-1PC31-1UL0	6SL3210-1PC31-3UL0 6SL3210-1PC31-6UL0 6SL3210-1PC31-8UL0
• Frame size		FSC	FSD	FSE	FSF

## SINAMICS G120 standard converters

0.37 kW to 250 kW (0.5 hp to 400 hp)

### DC link components > Braking resistors

#### Technical specifications

Line voltage 380 ... 480 V 3 AC		Braking resistor			
		6SL3201-0BE14-3AA0	6SL3201-0BE21-0AA0	6SL3201-0BE21-8AA0	6SL3201-0BE23-8AA0
<b>Resistance</b>	Ω	370	140	75	30
<b>Rated power <math>P_{DB}</math></b> (Continuous braking power)	kW	0.075	0.2	0.375	0.925
<b>Peak power <math>P_{max}</math></b> (load duration $t_a = 12$ s with period $t = 240$ s)	kW	1.5	4	7.5	18.5
<b>Power connection</b>		Terminal block	Terminal block	Terminal block	Terminal block
• Conductor cross-section	mm <sup>2</sup>	2.5	2.5	4	6
<b>Thermostatic switch</b>		NC contact	NC contact	NC contact	NC contact
• Contact load, max.		250 V AC/2.5 A	250 V AC/2.5 A	250 V AC/2.5 A	250 V AC/2.5 A
• Conductor cross-section	mm <sup>2</sup>	2.5	2.5	2.5	2.5
<b>PE connection</b>					
• Via terminal block		Yes	Yes	Yes	Yes
• PE connection on housing		M4 screw	M4 screw	M4 screw	M4 screw
<b>Degree of protection</b>		IP20	IP20	IP20	IP20
<b>Dimensions</b>					
• Width	mm (in)	105 (4.13)	105 (4.13)	175 (6.89)	250 (9.84)
• Height	mm (in)	295 (11.61)	345 (13.58)	345 (13.58)	490 (19.29)
• Depth	mm (in)	100 (3.94)	100 (3.94)	100 (3.94)	140 (5.51)
<b>Weight, approx.</b>	kg (lb)	1.48 (3.26)	1.8 (3.97)	2.73 (6.02)	6.2 (13.7)
<b>Suitable for PM240-2 Power Module standard variant</b>	Type	6SL3210-1PE11-8 . L1 6SL3210-1PE12-3 . L1 6SL3210-1PE13-2 . L1 6SL3210-1PE14-3 . L1	6SL3210-1PE16-1 . L1 6SL3210-1PE18-0 . L1	6SL3210-1PE21-1 . L0 6SL3210-1PE21-4 . L0 6SL3210-1PE21-8 . L0	6SL3210-1PE22-7 . L0 6SL3210-1PE23-3 . L0
• Frame size		FSA	FSA	FSB	FSC

Line voltage 380 ... 480 V 3 AC		Braking resistor				
		JJY:023422620001	JJY:023424020001	JJY:023434020001	JJY:023454020001 <sup>1)</sup>	JJY:023464020001 <sup>2)</sup>
<b>Resistance</b>	Ω	25	15	10	7.1	5
<b>Rated power <math>P_{DB}</math></b> (Continuous braking power)	kW	1.1	1.85	2.75	3.85	5.5
<b>Peak power <math>P_{max}</math></b> (load duration $t_a = 12$ s with period $t = 240$ s)	kW	22	37	55	77	110
<b>Power connection</b>		Cable	Cable	Cable	Cable	Cable
<b>Thermostatic switch</b>		Integrated	Integrated	Integrated	Integrated	Integrated
<b>Degree of protection</b>		IP21	IP21	IP21	IP21	IP21
<b>Dimensions</b>						
• Width	mm (in)	220 (8.66)	220 (8.66)	350 (13.78)	1)	2)
• Height	mm (in)	470 (18.5)	610 (24.02)	630 (24.8)	1)	2)
• Depth	mm (in)	180 (7.09)	180 (7.09)	180 (7.09)	1)	2)
<b>Weight, approx.</b>	kg (lb)	7 (15.4)	9.5 (20.9)	13.5 (29.8)	20.5 (45.2)	27 (59.5)
<b>Suitable for PM240-2 Power Module standard variant</b>	Type	6SL3210-1PE23-8 . L0 6SL3210-1PE24-5 . L0	6SL3210-1PE26-0 . L0 6SL3210-1PE27-5 . L0	6SL3210-1PE28-8 . L0 6SL3210-1PE31-1 . L0	6SL3210-1PE31-5 . L0 6SL3210-1PE31-8 . L0	6SL3210-1PE32-1 . L0 6SL3210-1PE32-5 . L0
• Frame size		FSD	FSD	FSE	FSF	FSF

<sup>1)</sup> This braking resistor consists of the two braking resistors, JJY:023422620001 and JJY:023434020001, which must be connected in parallel on the plant/system side.

<sup>2)</sup> This braking resistor consists of two JJY:023434020001 braking resistors, which must be connected in parallel on the plant/system side.



# SINAMICS G120 standard converters

0.37 kW to 250 kW (0.5 hp to 400 hp)

DC link components > Braking resistors

## Technical specifications

Line voltage 500 ... 690 V 3 AC		Braking resistor		
		JJY:023424020002	JJY:023434020002	JJY:023464020002 <sup>1)</sup>
Resistance	Ω	31	21	10.5
Rated power $P_{DB}$ (Continuous braking power)	kW	1.85	2.75	5.5
Peak power $P_{max}$ (load duration $t_a = 12$ s with period $t = 240$ s)	kW	37	55	110
Power connection		Cable	Cable	Cable
Thermostatic switch		Integrated	Integrated	Integrated
Degree of protection		IP21	IP21	IP21
Dimensions				
• Width	mm (in)	220 (8.66)	350 (13.78)	1)
• Height	mm (in)	610 (24.02)	630 (24.8)	1)
• Depth	mm (in)	180 (7.09)	180 (7.09)	1)
Weight, approx.	kg (lb)	9.5 (20.9)	13.5 (29.8)	27 (59.5)
Suitable for PM240-2 Power Module	Type	6SL3210-1PH21-4 . LO 6SL3210-1PH22-0 . LO 6SL3210-1PH22-3 . LO 6SL3210-1PH22-7 . LO 6SL3210-1PH23-5 . LO 6SL3210-1PH24-2 . LO	6SL3210-1PH25-2 . LO 6SL3210-1PH26-2 . LO	6SL3210-1PH28-0 . LO 6SL3210-1PH31-0 . LO 6SL3210-1PH31-2 . LO 6SL3210-1PH31-4 . LO
• Frame size		FSD	FSE	FSF

Line voltage 380 ... 480 V 3 AC or 500 ... 690 V 3 AC		Braking resistor	
		6SL3000-1BE32-5AA0	6SL3000-1BH32-5AA0
Resistance	Ω	2.2	4.9
Rated power $P_{DB}$ (Continuous braking power for operation with PM240-2)	kW	12.5	12.5
Peak power $P_{max}$ (load duration $t_a = 12$ s with period $t = 240$ s)	kW	250	250
Power connection		M10 screw stud	M10 screw stud
Thermostatic switch		NC contact	NC contact
• Contact load, max.		250 V AC/2.5 A	250 V AC/2.5 A
Degree of protection		IP20	IP20
Dimensions			
• Width	mm (in)	810 (31.89)	810 (31.89)
• Height	mm (in)	1325 (52.17)	1325 (52.17)
• Depth	mm (in)	485 (19.09)	485 (19.09)
Weight, approx.	kg (lb)	120 (265)	120 (265)
Suitable for PM240-2 Power Module	Type	400 V: 6SL3210-1PE33-0 . LO 6SL3210-1PE33-7 . LO 6SL3210-1PE34-8 . LO	690 V: 6SL3210-1PH31-7CLO 6SL3210-1PH32-1CLO 6SL3210-1PH32-5CLO
• Frame size		FSG	FSG

## Characteristic curves

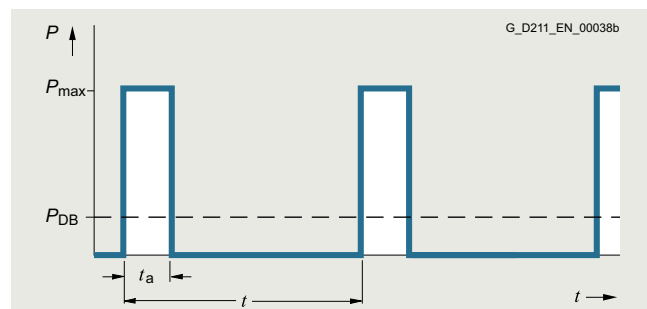

Load diagram for the braking resistors

$t_a = 12$  s  
 $t = 240$  s

<sup>1)</sup> This braking resistor consists of two JJY:023434020002 braking resistors, which must be connected in parallel on the plant/system side.

## SINAMICS G120 standard converters

0.37 kW to 250 kW (0.5 hp to 400 hp)

### Load-side power components > Output reactors

#### Overview

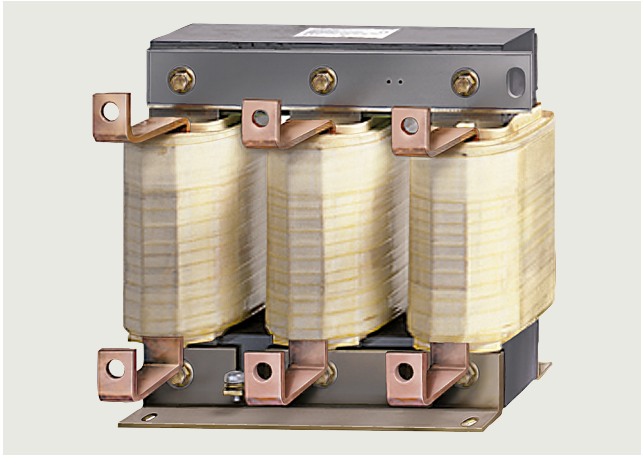

Output reactor for PM240-2 Power Modules, frame size FSG

Output reactors reduce the rate of voltage rise ( $dv/dt$ ) and the height of the current peaks, and enable longer motor cables to be connected.

Owing to the high rates of voltage rise of the fast-switching IGBTs, the capacitance of long motor cables reverses polarity very quickly with every switching operation in the inverter. As a result, the inverter is loaded with additional current peaks of substantial magnitude.

Output reactors reduce the magnitude of these additional peaks because the cable capacitance reverses polarity more slowly across the reactor inductance, thereby attenuating the amplitudes of the current peaks.

When using output reactors, the following should be observed:

- Max. permissible output frequency 150 Hz
- Max. permissible pulse frequency 4 kHz
- The output reactor must be installed as close as possible to the Power Module

#### Integration

**Output reactors that are optionally available depending on the Power Module used**

	Frame size						
	FSA	FSB	FSC	FSD	FSE	FSF	FSG
<b>PM240-2 Power Module with integrated braking chopper</b>							
• 200 V versions	✓	✓	✓	✓	✓	✓	–
• 400 V versions	✓	✓	✓	✓	✓	✓	✓
• 690 V versions	–	–	–	✓	✓	✓	✓
<b>Load-side power components</b>							
Output reactor	S	S	S	S	S	S	S
<b>PM250 Power Module with line-commutated energy recovery</b>							
• 400 V versions	–	–	✓	✓	✓	✓	–
<b>Load-side power components</b>							
Output reactor	–	–	U	S	S	S	–

U = Base component  
S = Lateral mounting  
– = Not possible

## SINAMICS G120 standard converters

0.37 kW to 250 kW (0.5 hp to 400 hp)

Load-side power components > Output reactors

### Selection and ordering data

Rated power		PM240-2 Power Module Standard variant		Output reactor (The prefix "JTA:" is part of a Siemens internal order code which does not belong to the product number of the original equipment manufacturer Mdexx Magnetronic Devices s. r. o.)
kW	hp	Type 6SL3210-...	Frame size	Article No.
<b>200 ... 240 V 1 AC/3 AC</b>				
0.55	0.75	1PB13-0 . L0	FSA	<b>6SL3202-0AE16-1CA0</b>
0.75	1	1PB13-8 . L0		
1.1	1.5	1PB15-5 . L0	FSB	<b>6SL3202-0AE16-1CA0</b>
1.5	2	1PB17-4 . L0	FSB	<b>6SL3202-0AE18-8CA0</b>
2.2	3	1PB21-0 . L0	FSB	<b>6SL3202-0AE21-8CA0</b>
3	4	1PB21-4 . L0	FSC	<b>6SL3202-0AE21-8CA0</b>
4	5	1PB21-8 . L0		
<b>200 ... 240 V 3 AC</b>				
5.5	7.5	1PC22-2 . L0	FSC	<b>6SL3202-0AE23-8CA0</b>
7.5	10	1PC22-8 . L0		
11	15	1PC24-2UL0	FSD	<b>6SE6400-3TC07-5ED0</b>
15	20	1PC25-4UL0		
18.5	25	1PC26-8UL0		
22	30	1PC28-0UL0	FSE	<b>6SE6400-3TC14-5FD0</b>
30	40	1PC31-1UL0		
37	50	1PC31-3UL0	FSF	<b>6SE6400-3TC14-5FD0</b>
45	60	1PC31-6UL0		
55	75	1PC31-8UL0		
<b>380 ... 480 V 3 AC</b>				
0.55	0.75	1PE11-8 . L1	FSA	<b>6SL3202-0AE16-1CA0</b>
0.75	1	1PE12-3 . L1		
1.1	1.5	1PE13-2 . L1		
1.5	2	1PE14-3 . L1		
2.2	3	1PE16-1 . L1		
3	4	1PE18-0 . L1	FSA	<b>6SL3202-0AE18-8CA0</b>
4	5	1PE21-1 . L0	FSB	<b>6SL3202-0AE21-8CA0</b>
5.5	7.5	1PE21-4 . L0		
7.5	10	1PE21-8 . L0		
11	15	1PE22-7 . L0	FSC	<b>6SL3202-0AE23-8CA0</b>
15	20	1PE23-3 . L0		
18.5	25	1PE23-8 . L0	FSD	<b>6SE6400-3TC07-5ED0</b>
22	30	1PE24-5 . L0		
30	40	1PE26-0 . L0		
37	50	1PE27-5 . L0		
45	60	1PE28-8 . L0	FSE	<b>6SE6400-3TC14-5FD0</b>
55	75	1PE31-1 . L0		
75	100	1PE31-5 . L0	FSF	<b>6SE6400-3TC14-5FD0</b>
90	125	1PE31-8 . L0		
110	150	1PE32-1 . L0	FSF	<b>6SL3000-2BE32-1AA0</b>
132	200	1PE32-5 . L0	FSF	<b>6SL3000-2BE32-6AA0</b>
160	250	1PE33-0 . L0	FSG	<b>6SL3000-2BE33-2AA0</b>
200	300	1PE33-7 . L0	FSG	<b>6SL3000-2BE33-8AA0</b>
250	400	1PE34-8 . L0	FSG	<b>6SL3000-2BE35-0AA0</b>

**SINAMICS G120 standard converters**

0.37 kW to 250 kW (0.5 hp to 400 hp)

Load-side power components &gt; Output reactors

**Selection and ordering data**

Rated power		<b>PM240-2 Power Module</b> Standard variant		<b>Output reactor</b> (The prefix "JTA:" is part of a Siemens internal order code which does not belong to the product number of the original equipment manufacturer Mdexx Magnetronic Devices s. r. o.)
kW	hp	Type 6SL3210-...	Frame size	Article No.
<b>500 ... 690 V 3 AC</b>				
11	15	1PH21-4 . L0	FSD	<b>JTA:TEU2532-0FP00-4EA0</b>
15	20	1PH22-0 . L0		
18.5	25	1PH22-3 . L0		
22	30	1PH22-7 . L0	FSD	<b>JTA:TEU9932-0FP00-4EA0</b>
30	40	1PH23-5 . L0		
37	50	1PH24-2 . L0		
45	60	1PH25-2 . L0	FSE	<b>JTA:TEU9932-0FS00-0EA0</b>
55	75	1PH26-2 . L0		
75	75	1PH28-0 . L0	FSF	<b>JTA:TEU9932-1FC00-1BA0</b>
90	100	1PH31-0 . L0		
110	100	1PH31-2 . L0	FSF	<b>JTA:TEU9932-0FV00-1BA0</b>
132	125	1PH31-4 . L0		
160	150	1PH31-7CL0	FSG	<b>JTA:TEU4732-0FA00-0BA0</b>
200	200	1PH32-1CL0		
250	250	1PH32-5CL0		

Rated power		<b>PM250 Power Module</b>		<b>Output reactor</b>
kW	hp	Type 6SL3225-...	Frame size	Article No.
<b>380 ... 480 V 3 AC</b>				
7.5	10	0BE25-5AA1	FSC	<b>6SL3202-0AJ23-2CA0</b>
11	15	0BE27-5AA1		
15	20	0BE31-1AA1		
18.5	25	0BE31-5 . A0	FSD	<b>6SE6400-3TC03-8DD0</b>
22	30	0BE31-8 . A0	FSD	
30	40	0BE32-2 . A0		
37	50	0BE33-0 . A0	FSE	<b>6SE6400-3TC08-0ED0</b>
45	60	0BE33-7 . A0	FSE	
55	75	0BE34-5 . A0	FSF	<b>6SE6400-3TC14-5FD0</b>
75	100	0BE35-5 . A0	FSF	
90	125	0BE37-5 . A0	FSF	<b>6SE6400-3TC14-5FD0</b>

## SINAMICS G120 standard converters

0.37 kW to 250 kW (0.5 hp to 400 hp)

### Load-side power components > Output reactors

#### Technical specifications

Line voltage 200 ... 240 V 1 AC/3 AC or 380 ... 480 V 3 AC		Output reactor (for a 4 kHz pulse frequency)			
		6SL3202-0AE16-1CA0	6SL3202-0AE18-8CA0	6SL3202-0AE21-8CA0	6SL3202-0AE23-8CA0
<b>Rated current</b>	A	6.1	9	18.5	39
<b>Power loss</b>	kW	0.09	0.08	0.08	0.11
<b>Connection to the Power Module/ motor connection</b>		Screw terminals	Screw terminals	Screw terminals	Screw terminals
• Conductor cross-section	mm <sup>2</sup>	4	4	10	16
<b>PE connection</b>		M4 screw stud	M4 screw stud	M5 screw stud	M5 screw stud
<b>Cable length, max.</b> between output reactor and motor					
• 200 -10 % ... 240 V +10 % 3 AC and 380 -10 % ... 415 V +10 % 3 AC					
- Shielded	m (ft)	150 (492)	150 (492)	150 (492)	150 (492)
- Unshielded	m (ft)	225 (738)	225 (738)	225 (738)	225 (738)
• 440 ... 480 V 3 AC +10 %					
- Shielded	m (ft)	100 (328)	100 (328)	100 (328)	100 (328)
- Unshielded	m (ft)	150 (492)	150 (492)	150 (492)	150 (492)
<b>Dimensions</b>					
• Width	mm (in)	207 (8.15)	207 (8.15)	247 (9.72)	257 (10.12)
• Height	mm (in)	175 (6.89)	180 (7.09)	215 (8.46)	235 (9.25)
• Depth	mm (in)	72.5 (2.85)	72.5 (2.85)	100 (3.94)	114.7 (4.52)
<b>Degree of protection</b>		IP20	IP20	IP20	IP20
<b>Weight, approx.</b>	kg (lb)	3.4 (7.5)	3.9 (8.6)	10.1 (22.3)	11.2 (24.7)
<b>Suitable for PM240-2 Power Module standard variant 200 ... 240 V 1 AC/3 AC</b>	Type	6SL3210-1PB13-0 . L0 6SL3210-1PB13-8 . L0 FSA  6SL3210-1PB15-5 . L0 FSB	6SL3210-1PB17-4 . L0 FSB	6SL3210-1PB21-0 . L0 FSB  6SL3210-1PB21-4 . L0 6SL3210-1PB21-8 . L0 FSC	6SL3210-1PC22-2 . L0 6SL3210-1PC22-8 . L0 FSC
<b>Suitable for PM240-2 Power Module standard variant 380 ... 480 V 3 AC</b>	Type	6SL3210-1PE11-8 . L1 6SL3210-1PE12-3 . L1 6SL3210-1PE13-2 . L1 6SL3210-1PE14-3 . L1 6SL3210-1PE16-1 . L1 FSA	6SL3210-1PE18-0 . L1 FSA	6SL3210-1PE21-1 . L0 6SL3210-1PE21-4 . L0 6SL3210-1PE21-8 . L0 FSB	6SL3210-1PE22-7 . L0 6SL3210-1PE23-3 . L0 FSC

## SINAMICS G120 standard converters

0.37 kW to 250 kW (0.5 hp to 400 hp)

### Load-side power components > Output reactors

#### Technical specifications

Line voltage 200 ... 240 V 3 AC or 380 ... 480 V 3 AC		Output reactor (for a 4 kHz pulse frequency)			
		6SE6400-3TC07-5ED0	6SE6400-3TC14-5FD0	6SL3000-2BE32-1AA0	6SL3000-2BE32-6AA0
<b>Rated current</b>	A	90	178	210	260
<b>Power loss, max.</b>	kW	0.27	0.47	0.49	0.5
<b>Connection to the Power Module/ motor connection</b>		Flat connector for M6 screw	Flat connector for M8 screw	Flat connector for M10 screw	Flat connector for M10 screw
<b>PE connection</b>		M6 screw	M8 screw	M8 screw	M8 screw
<b>Cable length, max.</b> between output reactor and motor					
• Shielded	m (ft)	200 (656)	200 (656)	300 (984)	300 (984)
• Unshielded	m (ft)	300 (984)	300 (984)	450 (1476)	450 (1476)
<b>Dimensions</b>					
• Width	mm (in)	270 (10.63)	350 (13.78)	300 (11.81)	300 (11.81)
• Height	mm (in)	248 (9.76)	321 (12.64)	285 (11.22)	315 (12.40)
• Depth	mm (in)	209 (8.23)	288 (11.34)	257 (10.12)	277 (10.91)
<b>Degree of protection</b>		IP00	IP00	IP00	IP00
<b>Weight, approx.</b>	kg (lb)	27 (59.5)	57 (126)	60 (132)	66 (146)
<b>Suitable for PM240-2 Power Module standard variant 200 ... 240 V 3 AC</b>	Type	6SL3210-1PC24-2UL0 6SL3210-1PC25-4UL0 6SL3210-1PC26-8UL0 FSD	6SL3210-1PC28-0UL0 6SL3210-1PC31-1UL0 FSE 6SL3210-1PC31-3UL0 6SL3210-1PC31-6UL0 6SL3210-1PC31-8UL0 FSF	–	–
<b>Suitable for PM240-2 Power Module standard variant 380 ... 480 V 3 AC</b>	Type	6SL3210-1PE23-8 . L0 6SL3210-1PE24-5 . L0 6SL3210-1PE26-0 . L0 6SL3210-1PE27-5 . L0 FSD	6SL3210-1PE28-8 . L0 6SL3210-1PE31-1 . L0 FSE 6SL3210-1PE31-5 . L0 6SL3210-1PE31-8 . L0 FSF	6SL3210-1PE32-1 . L0 FSF	6SL3210-1PE32-5 . L0 FSF

## SINAMICS G120 standard converters

0.37 kW to 250 kW (0.5 hp to 400 hp)

Load-side power components > Output reactors

### Technical specifications

Line voltage 380 ... 480 V 3 AC		Output reactor (for a 4 kHz pulse frequency)		
		6SL3000-2BE33-2AA0	6SL30V00-2BE33-8AA0	6SL3000-2BE35-0AA0
<b>Rated current</b>	A	310	380	490
<b>Power loss</b>	kW	0.47	0.5	0.5
<b>Connection to the Power Module</b>		1 × hole for M10	1 × hole for M10	1 × hole for M12
<b>PE connection</b>		M6 screw	M6 screw	M6 screw
<b>Cable length, max.</b> between output reactor and motor				
• Shielded	m (ft)	300 (984)	300 (984)	300 (984)
• Unshielded	m (ft)	450 (1476)	450 (1476)	450 (1476)
<b>Dimensions</b>				
• Width	mm (in)	300 (11.81)	300 (11.81)	300 (11.81)
• Height	mm (in)	285 (11.22)	285 (11.22)	365 (14.37)
• Depth	mm (in)	257 (10.12)	277 (10.91)	277 (10.91)
<b>Degree of protection</b>		IP00	IP00	IP00
<b>Weight, approx.</b>	kg (lb)	66 (146)	73 (161)	100 (220)
<b>Suitable for PM240-2 Power Module standard variant</b>	Type	6SL3210-1PE33-0 . L0 FSG	6SL3210-1PE33-7 . L0 FSG	6SL3210-1PE34-8 . L0 FSG

Line voltage 500 ... 690 V 3 AC		Output reactor (for a 4 kHz pulse frequency)		
		JTA:TEU2532-0FP00-4EA0	JTA:TEU9932-0FP00-4EA0	JTA:TEU9932-0FS00-0EA0
<b>Rated current</b>	A	24	44	64
<b>Power loss, max.</b>	kW	0.13	0.3	0.4
<b>Connection to the Power Module/ motor connection</b>		Screw terminals	Screw terminals	Screw terminals
• Conductor cross-section	mm <sup>2</sup>	16	35	70
<b>PE connection</b>		Screw terminals	Screw terminals	Screw terminals
• Conductor cross-section	mm <sup>2</sup>	16	35	70
<b>Cable length, max.</b> between output reactor and motor				
• Shielded	m (ft)	350 (1148)	350 (1148)	350 (1148)
• Unshielded	m (ft)	525 (1723)	525 (1723)	525 (1723)
<b>Dimensions</b>				
• Width	mm (in)	264 (10.39)	264 (10.39)	310 (12.20)
• Height	mm (in)	255 (10.04)	270 (10.63)	370 (14.57)
• Depth	mm (in)	131 (5.16)	159 (6.26)	182 (7.17)
<b>Degree of protection</b>		IP00	IP00	IP00
<b>Weight, approx.</b>	kg (lb)	18 (39.7)	26 (57.3)	42 (92.6)
<b>Suitable for PM240-2 Power Module standard variant</b>	Type	6SL3210-1PH21-4 . L0 6SL3210-1PH22-0 . L0 6SL3210-1PH22-3 . L0 FSD	6SL3210-1PH22-7 . L0 6SL3210-1PH23-5 . L0 6SL3210-1PH24-2 . L0 FSD	6SL3210-1PH25-2 . L0 6SL3210-1PH26-2 . L0 FSE

## SINAMICS G120 standard converters

0.37 kW to 250 kW (0.5 hp to 400 hp)

### Load-side power components > Output reactors

#### Technical specifications

Line voltage 500 ... 690 V 3 AC		Output reactor (for a 4 kHz pulse frequency)		
		JTA:TEU9932-1FC00-1BA0	JTA:TEU9932-0FV00-1BA0	JTA:TEU4732-0FA00-0BA0
<b>Rated current</b>	A	103	146	260
<b>Power loss, max.</b>	kW	0.42	0.52	0.86
<b>Connection to the Power Module/ motor connection</b>		Flat connector for M8 cable lug	Flat connector for M10 cable lug	Flat connector for M10 cable lug
• Conductor cross-section	mm <sup>2</sup>	95	120	185 or 2 × 120
<b>PE connection</b>		Cable lug for M6 screw	Cable lug for M6 screw	Cable lug for M6 screw
• Conductor cross-section	mm <sup>2</sup>	50	70	95
<b>Cable length, max.</b> between output reactor and motor				
• Shielded	m (ft)	525 (1723)	525 (1723)	525 (1723)
• Unshielded	m (ft)	800 (2625)	800 (2625)	800 (2625)
<b>Dimensions</b>				
• Width	mm (in)	400 (15.75)	400 (15.75)	460 (18.11)
• Height	mm (in)	320 (12.60)	355 (13.98)	430 (16.93)
• Depth	mm (in)	235 (9.25)	258 (10.16)	310 (12.20)
<b>Degree of protection</b>		IP00	IP00	IP00
<b>Weight, approx.</b>	kg (lb)	66 (146)	90 (198)	162 (357)
<b>Suitable for PM240-2 Power Module standard variant</b>	Type	6SL3210-1PH28-0 . L0 6SL3210-1PH31-0 . L0 FSF	6SL3210-1PH31-2 . L0 6SL3210-1PH31-4 . L0 FSF	6SL3210-1PH31-7 . L0 6SL3210-1PH32-1 . L0 6SL3210-1PH32-5 . L0 FSG

Line voltage 380 ... 480 V 3 AC		Output reactor (for a 4 kHz pulse frequency)	
		6SL3202-0AJ23-2CA0	
<b>Rated current</b>	A	32	
<b>Power loss</b>	kW	0.06	
<b>Connection to the Power Module</b>		Cable	
• Conductor cross-section		4 × AWG14 (1.5 mm <sup>2</sup> )	
• Length, approx.	m (ft)	0.35 (1.15)	
<b>Motor connection</b>		Screw terminals	
• Conductor cross-section	mm <sup>2</sup>	6	
<b>PE connection</b>		M5 screw stud	
<b>Cable length, max.</b> between output reactor and motor			
• 380 -10 % ... 400 V 3 AC			
- Shielded	m (ft)	150 (492)	
- Unshielded	m (ft)	225 (738)	
• 401 ... 480 V 3 AC +10 %			
- Shielded	m (ft)	100 (328)	
- Unshielded	m (ft)	150 (492)	
<b>Dimensions</b>			
• Width	mm (in)	189 (7.44)	
• Height	mm (in)	334 (13.15)	
• Depth	mm (in)	80 (3.15)	
<b>Possible as base component</b>		Yes	
<b>Degree of protection</b>		IP00	
<b>Weight, approx.</b>	kg (lb)	9.1 (20.1)	
<b>Suitable for PM250 Power Module</b>	Type	6SL3225-0BE25-5AA1 6SL3225-0BE27-5AA1 6SL3225-0BE31-1AA1 FSC	



# SINAMICS G120 standard converters

## 0.37 kW to 250 kW (0.5 hp to 400 hp)

### Load-side power components > Output reactors

#### Technical specifications

Line voltage 380 ... 480 V 3 AC		Output reactor (for a 4 kHz pulse frequency)			
		6SE6400-3TC03-8DD0	6SE6400-3TC05-4DD0	6SE6400-3TC08-0ED0	6SE6400-3TC07-5ED0
<b>Rated current</b>	A	45 <sup>1)</sup>	68 <sup>1)</sup>	104 <sup>1)</sup>	90 <sup>1)</sup>
<b>Power loss</b>	kW	0.2	0.2	0.17	0.27
<b>Connection to the Power Module</b>		Flat connector for M6 cable lug	Flat connector for M6 cable lug	Flat connector for M6 cable lug	Flat connector for M6 cable lug
<b>Motor connection</b>		Flat connector for M6 cable lug	Flat connector for M6 cable lug	Flat connector for M6 cable lug	Flat connector for M6 cable lug
<b>PE connection</b>		M6 screw	M6 screw	M6 screw	M6 screw
<b>Cable length, max.</b> between output reactor and motor					
• 380 -10 % ... 400 V 3 AC					
- Shielded	m (ft)	200 (656)	200 (656)	200 (656)	200 (656)
- Unshielded	m (ft)	300 (984)	300 (984)	300 (984)	300 (984)
• 401 ... 480 V 3 AC +10 %					
- Shielded	m (ft)	200 (656)	200 (656)	200 (656)	200 (656)
- Unshielded	m (ft)	300 (984)	300 (984)	300 (984)	300 (984)
<b>Dimensions</b>					
• Width	mm (in)	225 (8.86)	225 (8.86)	225 (8.86)	270 (10.63)
• Height	mm (in)	210 (8.27)	210 (8.27)	210 (8.27)	248 (9.76)
• Depth	mm (in)	179 (7.05)	150 (5.91)	150 (5.91)	209 (8.23)
<b>Degree of protection</b>		IP00	IP00	IP00	IP00
<b>Weight, approx.</b>	kg (lb)	16.1 (35.5)	10.7 (23.6)	10.4 (22.9)	24.9 (54.9)
<b>Suitable for PM250 Power Module</b>	Type	6SL3225-0BE31-5 . A0 FSD	6SL3225-0BE31-8 . A0 6SL3225-0BE32-2 . A0 FSD	6SL3225-0BE33-0 . A0 FSE	6SL3225-0BE33-7 . A0 FSE

Line voltage 380 ... 480 V 3 AC		Output reactor (for a 4 kHz pulse frequency)	
		6SE6400-3TC14-5FD0	6SE6400-3TC15-4FD0
<b>Rated current</b>	A	178 <sup>1)</sup>	178 <sup>1)</sup>
<b>Power loss</b>	kW	0.47	0.25
<b>Connection to the Power Module</b>		Flat connector for M8 cable lug	Flat connector for M8 cable lug
<b>Motor connection</b>		Flat connector for M8 cable lug	Flat connector for M8 cable lug
<b>PE connection</b>		M8 screw	M6 screw
<b>Cable length, max.</b> between output reactor and motor			
• 380 -10 % ... 400 V 3 AC			
- Shielded	m (ft)	200 (656)	200 (656)
- Unshielded	m (ft)	300 (984)	300 (984)
• 401 ... 480 V 3 AC +10 %			
- Shielded	m (ft)	200 (656)	200 (656)
- Unshielded	m (ft)	300 (984)	300 (984)
<b>Dimensions</b>			
• Width	mm (in)	350 (13.78)	270 (10.63)
• Height	mm (in)	321 (12.64)	248 (9.76)
• Depth	mm (in)	288 (11.34)	209 (8.23)
<b>Degree of protection</b>		IP00	IP00
<b>Weight, approx.</b>	kg (lb)	51.5 (114)	24 (52.9)
<b>Suitable for PM250 Power Module</b>	Type	6SL3225-0BE34-5 . A0 6SL3225-0BE37-5 . A0 FSF	6SL3225-0BE35-5 . A0 FSF

<sup>1)</sup> On the rating plate of the reactor the current is specified according to the duty cycle for high overload (HO). This is lower than the current specified according to the duty cycle for low overload (LO) of the Power Module.

## SINAMICS G120 standard converters

0.37 kW to 250 kW (0.5 hp to 400 hp)

### Load-side power components > Sine-wave filters

#### Overview

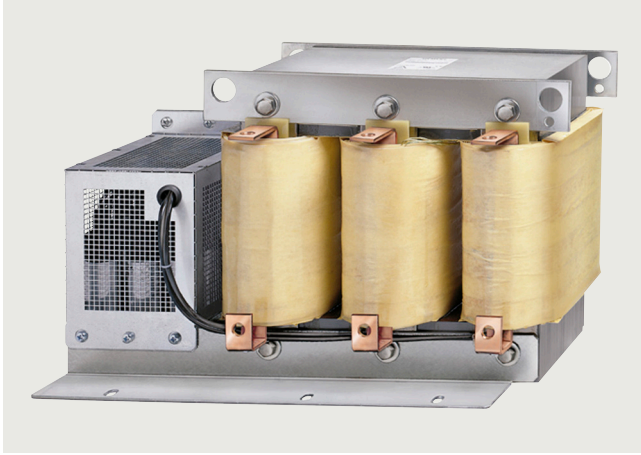

Sine-wave filter

Sine-wave filters limit the rate of voltage rise ( $dv/dt$ ) and the peak voltages on the motor winding. Similar to an output reactor, they enable the connection of longer motor cables.

Bearing currents are also reduced significantly. Using these filters therefore allows standard motors with standard insulation and without insulated bearings to be operated on SINAMICS. As a result, the voltage load on the motor winding is virtually identical to the load on windings of directly mains-fed motors.

Owing to the very low rates of voltage rise on the motor cable, the sine-wave filter also has a positive impact in terms of electromagnetic compatibility which means that it is not absolutely essential to use shielded cables for short motor cables to achieve the required standard of EMC.

Since the voltage applied to the motor is not pulsed, the converter-related stray losses and additional noise in the motor are also reduced considerably and the noise level of the motor is similar to the level produced by directly mains-fed motors.

When using sine-wave filters, the following should be observed:

- Pulse frequencies of between 4 kHz and 8 kHz are permissible for rated outputs up to and including 90 kW
- The output frequency is limited to 150 Hz.
- Operation and commissioning may only be performed with the motor connected as the sine-wave filter is not no-load proof
- It must be ensured that the automatic pulse frequency reduction functions are also deactivated

#### Integration

##### Sine-wave filters that are optionally available depending on the Power Module used

	Frame size						
	FSA	FSB	FSC	FSD	FSE	FSF	FSG
<b>PM240-2 Power Module with integrated braking chopper</b>							
• 200 V versions	✓	✓	✓	✓	✓	✓	–
• 400 V versions	✓	✓	✓	✓	✓	✓	✓
• 690 V versions	–	–	–	✓	✓	✓	✓
<b>Load-side power components</b>							
Sine-wave filter (only for 400 V versions)	S	S	S	–	–	–	–
<b>PM250 Power Module with line-commutated energy recovery</b>							
• 400 V versions	–	–	✓	✓	✓	✓	–
<b>Load-side power components</b>							
Sine-wave filter	–	–	U	S	S	S	–

U = Base component

S = Lateral mounting

– = Not possible

## SINAMICS G120 standard converters

0.37 kW to 250 kW (0.5 hp to 400 hp)

Load-side power components > Sine-wave filters

### Selection and ordering data

Rated power		PM240-2 Power Module		Sine-wave filter
kW	hp	Standard variant	Frame size	Article No.
380 ... 480 V 3 AC		Type 6SL3210-...		
0.55	0.75	1PE11-8 . L1	FSA	<b>6SL3202-0AE20-3SA0</b>
0.75	1	1PE12-3 . L1		
1.1	1.5	1PE13-2 . L1		
1.5	2	1PE14-3 . L1	FSA	<b>6SL3202-0AE20-6SA0</b>
2.2	3	1PE16-1 . L1		
3	4	1PE18-0 . L1	FSA	<b>6SL3202-0AE21-1SA0</b>
4	5	1PE21-1 . L0	FSB	<b>6SL3202-0AE21-4SA0</b>
5.5	7.5	1PE21-4 . L0		
7.5	10	1PE21-8 . L0	FSB	<b>6SL3202-0AE22-0SA0</b>
11	15	1PE22-7 . L0	FSC	<b>6SL3202-0AE23-3SA0</b>
15	20	1PE23-3 . L0		

Rated power		PM250 Power Module		Sine-wave filter
kW	hp	Standard variant	Frame size	Article No.
380 ... 480 V 3 AC		Type 6SL3225-...		
7.5	10	0BE25-5AA1	FSC	<b>6SL3202-0AE22-0SA0</b>
11	15	0BE27-5AA1	FSC	<b>6SL3202-0AE23-3SA0</b>
15	20	0BE31-1AA1		
18.5	25	0BE31-5 . A0	FSD	<b>6SL3202-0AE24-6SA0</b>
22	30	0BE31-8 . A0		
30	40	0BE32-2 . A0	FSD	<b>6SL3202-0AE26-2SA0</b>
37	50	0BE33-0 . A0	FSE	<b>6SL3202-0AE28-8SA0</b>
45	60	0BE33-7 . A0		
55	75	0BE34-5 . A0	FSF	<b>6SL3202-0AE31-5SA0</b>
75	100	0BE35-5 . A0		
90	125	0BE37-5 . A0	FSF	<b>6SL3202-0AE31-8SA0</b>

## SINAMICS G120 standard converters

0.37 kW to 250 kW (0.5 hp to 400 hp)

### Load-side power components > Sine-wave filters

#### Technical specifications

Line voltage 380 ... 480 V 3 AC		Sine-wave filter		
		6SL3202-0AE20-3SA0	6SL3202-0AE20-6SA0	6SL3202-0AE21-1SA0
<b>Rated current</b>	A	3.5	6	9
<b>Power loss</b>	kW	–	–	–
<b>Connection to the Power Module</b>		Cable	Cable	Cable
• Conductor cross-section, max.	mm <sup>2</sup>	6	6	6
• Length, approx.	m (ft)	0.5 (1.64)	0.5 (1.64)	0.5 (1.64)
<b>Motor connection</b>		Screw terminals	Screw terminals	Screw terminals
• Conductor cross-section, max.	mm <sup>2</sup>	6	6	6
<b>PE connection</b>		Screw studs	Screw studs	Screw studs
<b>Cable length, max.</b> between sine-wave filter and motor				
• Shielded	m (ft)	200 (656)	200 (656)	200 (656)
• Unshielded	m (ft)	300 (984)	300 (984)	300 (984)
<b>Dimensions</b>				
• Width	mm (in)	76.5 (3.01)	76.5 (3.01)	153 (6.02)
• Height	mm (in)	200 (7.87)	200 (7.87)	270 (10.63)
• Depth	mm (in)	110 (4.33)	110 (4.33)	100 (3.94)
<b>Possible as base component</b>		No	No	No
<b>Degree of protection</b>		IP00	IP00	IP00
<b>Weight, approx.</b>	kg (lb)	2.6 (5.73)	3 (6.62)	6 (13.2)
<b>Suitable for PM240-2 Power Module</b>	Type	6SL3210-1PE11-8 . L1 (FSA, 0.55 kW, 1.7 A) 6SL3210-1PE12-3 . L1 (FSA, 0.75 kW, 2.2 A) 6SL3210-1PE13-2 . L1 (FSA, 1.1 kW, 3.1 A)	6SL3210-1PE14-3 . L1 (FSA, 1.5 kW, 4.1 A) 6SL3210-1PE16-1 . L1 (FSA, 2.2 kW, 5.9 A)	6SL3210-1PE18-0 . L1 (FSA, 3 kW, 7.7 A)

## SINAMICS G120 standard converters

0.37 kW to 250 kW (0.5 hp to 400 hp)

### Load-side power components > Sine-wave filters

#### Technical specifications

Line voltage 380 ... 480 V 3 AC		Sine-wave filter		
		6SL3202-0AE21-4SA0	6SL3202-0AE22-0SA0	6SL3202-0AE23-3SA0
<b>Rated current</b>	A	14	20	33
<b>Power loss</b>	kW	–	0.099	0.151
<b>Connection to the Power Module</b>		Cable	Cable	Cable
• Conductor cross-section, max.	mm <sup>2</sup>	6	10	10
• Length, approx.	m (ft)	0.5 (1.64)	0.5 (1.64)	0.5 (1.64)
<b>Motor connection</b>		Screw terminals	Screw terminals	Screw terminals
• Conductor cross-section, max.	mm <sup>2</sup>	6	10	10
<b>PE connection</b>		Screw studs	M5 screw stud	M5 screw stud
<b>Cable length, max.</b> between sine-wave filter and motor				
• for <b>PM240-2</b>				
- Shielded	m (ft)	200 (656)	200 (656)	200 (656)
- Unshielded	m (ft)	300 (984)	300 (984)	300 (984)
• for <b>PM250</b>				
- Shielded	m (ft)	–	200 (656)	200 (656)
- Unshielded	m (ft)	–	300 (984)	300 (984)
<b>Dimensions</b>				
• Width	mm (in)	153 (6.02)	189 (7.44)	189 (7.44)
• Height	mm (in)	270 (10.63)	336 (13.23)	336 (13.23)
• Depth	mm (in)	100 (3.94)	140 (5.51)	140 (5.51)
<b>Possible as base component</b>		No	No	No
<b>Degree of protection</b>		IP00	IP00	IP00
<b>Weight, approx.</b>	kg (lb)	10 (22.1)	12 (26.5)	23 (50.7)
<b>Suitable for PM240-2 Power Module</b>	Type	6SL3210-1PE21-1 . L0 (FSB, 4 kW, 10.2 A) 6SL3210-1PE21-4 . L0 (FSB, 5.5 kW, 13.2 A)	6SL3210-1PE21-8 . L0 (FSB, 7.5 kW, 18 A)	6SL3210-1PE22-7 . L0 (FSC, 11 kW, 26 A) 6SL3210-1PE23-3 . L0 (FSC, 15 kW, 32 A)
<b>Suitable for PM250 Power Module</b>	Type	–	6SL3225-0BE25-5AA1 (FSC, 7.5 kW, 18 A)	6SL3225-0BE27-5AA1 (FSC, 11 kW, 25 A) 6SL3225-0BE31-1AA1 (FSC, 15 kW, 32 A)

Line voltage 380 ... 480 V 3 AC		Sine-wave filter		
		6SL3202-0AE24-6SA0	6SL3202-0AE26-2SA0	6SL3202-0AE28-8SA0
<b>Rated current</b>	A	47	61.8	92
<b>Power loss</b>	kW	0.185	0.152	0.251
<b>Connection to the Power Module</b>		Screw terminals	Screw terminals	Screw terminals
• Conductor cross-section, max.	mm <sup>2</sup>	50	50	95
<b>Motor connection</b>		Screw terminals	Screw terminals	Screw terminals
• Conductor cross-section, max.	mm <sup>2</sup>	50	50	95
<b>PE connection</b>		M6 screw	M6 screw	M8 screw
<b>Cable length, max.</b> between sine-wave filter and motor				
• Shielded	m (ft)	200 (656)	200 (656)	200 (656)
• Unshielded	m (ft)	300 (984)	300 (984)	300 (984)
<b>Dimensions</b>				
• Width	mm (in)	250 (9.84)	250 (9.84)	275 (10.83)
• Height	mm (in)	315 (12.40)	305 (12.01)	368 (14.49)
• Depth	mm (in)	262 (10.31)	262 (10.31)	275 (10.83)
<b>Degree of protection</b>		IP00	IP00	IP00
<b>Weight, approx.</b>	kg (lb)	24 (52.9)	34 (75.0)	45 (99.2)
<b>Suitable for PM250 Power Module</b>	Type	6SL3225-0BE31-5 . A0 (FSD, 18.5 kW, 38 A) 6SL3225-0BE31-8 . A0 (FSD, 22 kW, 45 A)	6SL3225-0BE32-2 . A0 (FSD, 30 kW, 60 A)	6SL3225-0BE33-0 . A0 (FSE, 37 kW, 75 A) 6SL3225-0BE33-7 . A0 (FSE, 45 kW, 90 A)

## SINAMICS G120 standard converters

0.37 kW to 250 kW (0.5 hp to 400 hp)

Load-side power components > Sine-wave filters

### Technical specifications

Line voltage 380 ... 480 V 3 AC		Sine-wave filter (for pulse frequencies 4 ... 8 kHz, only 4 kHz permissible at 110 kW and above – note additional current derating as compared with rated pulse frequency of 2 kHz, <a href="#">see derating data</a> )	
		6SL3202-0AE31-5SA0	6SL3202-0AE31-8SA0
Rated current	A	150	182
Power loss	kW	0.43	0.47
Connection to the Power Module		Screw terminals	Screw terminals
• Conductor cross-section, max.	mm <sup>2</sup>	150	150
Motor connection		Screw terminals	Screw terminals
• Conductor cross-section, max.	mm <sup>2</sup>	150	150
PE connection		M8 screw	M8 screw
Cable length, max. between sine-wave filter and motor			
• Shielded	m (ft)	200 (656)	200 (656)
• Unshielded	m (ft)	300 (984)	300 (984)
Dimensions			
• Width	mm (in)	350 (13.78)	350 (13.78)
• Height	mm (in)	440 (17.32)	468 (18.43)
• Depth	mm (in)	305 (12.01)	305 (12.01)
Degree of protection		IP00	IP00
Weight, approx.	kg (lb)	63 (139)	80 (176)
Suitable for PM250 Power Module	Type	6SL3225-0BE34-5 . A0 (FSF, 55 kW, 110 A) 6SL3225-0BE35-5 . A0 (FSF, 75 kW, 145 A)	6SL3225-0BE37-5 . A0 (FSF, 90 kW, 178 A)

## SINAMICS G120 standard converters

0.37 kW to 250 kW (0.5 hp to 400 hp)

### Load-side power components > dv/dt filters plus VPL

#### Overview

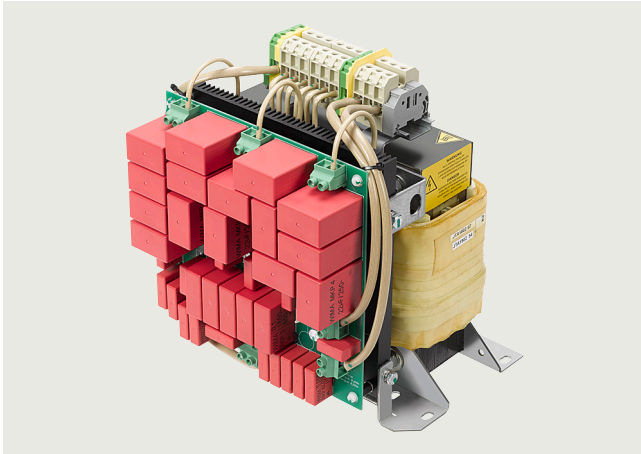

dv/dt filter plus VPL

dv/dt filters plus VPL (**V**oltage **P**eak **L**imiter) limit the voltage rate-of-rise  $dv/dt$  to values  $< 500 \text{ V}/\mu\text{s}$  and the typical voltage peaks to the following values according to the limit value curve to IEC/TS 60034-17: 2006:

- $< 1350 \text{ V}$  phase/phase at the motor terminals with a nominal DC link voltage of 935 V
- $< 1100 \text{ V}$  phase/ground at the motor terminals with a nominal DC link voltage of 935 V

Standard motors with standard insulation and without insulated bearings can be used for converter operation if a dv/dt filter plus VPL is used.

**JTA** dv/dt filters can be operated with SINAMICS G120 firmware V4.7 SP10 or higher.

#### Design

In terms of function, the dv/dt filter plus VPL consists of two components:

- dv/dt reactor
- Voltage limiting network, which cuts off the voltage peaks and feeds the energy back into the DC link.

#### Integration

##### dv/dt filters plus VPL that are available depending on the Power Module used

	Frame size						
	FSA	FSB	FSC	FSD	FSE	FSF	FSG
<b>PM240-2 Power Module with integrated braking chopper</b>							
• 200 V versions	✓	✓	✓	✓	✓	✓	–
• 400 V versions	✓	✓	✓	✓	✓	✓	✓
• 690 V versions	–	–	–	✓	✓	✓	✓
<b>Load-side power components</b>							
dv/dt filters plus VPL <sup>1)</sup> (for 400 V and 690 V versions only)	–	–	–	S	S	S	S

S = Lateral mounting  
– = Not possible

<sup>1)</sup> The 690 V versions of the PM240-2 Power Modules require motors with a suitable isolating system for 690 V converter operation (IVIC-C premium). The VSD10 line with corresponding SIMOTICS GP 1LE109 General Purpose motors or SIMOTICS SD 1LE159 Severe Duty motors is ideally suited for converter operation at 690 V.  
Additional information is available in Catalog D 81.1.

**SINAMICS G120 standard converters**

0.37 kW to 250 kW (0.5 hp to 400 hp)

Load-side power components &gt; dv/dt filters plus VPL

**Selection and ordering data**

Rated power		PM240-2 Power Module Standard variant		dv/dt filter plus VPL
kW	hp	Type 6SL3210-...	Frame size	(The prefix "JTA:" is part of a Siemens internal order code which does not belong to the product number of the original equipment manufacturer Mdexx Magnetronic Devices s. r. o.) Article No.
<b>380 ... 480 V 3 AC</b>				
18.5	25	1PE23-8 . LO	FSD	<b>JTA:TEF1203-0HB</b>
22	30	1PE24-5 . LO	FSD	<b>JTA:TEF1203-0JB</b>
30	40	1PE26-0 . LO		
37	50	1PE27-5 . LO	FSD	<b>JTA:TEF1203-0KB</b>
45	60	1PE28-8 . LO	FSE	
55	75	1PE31-1 . LO	FSE	<b>JTA:TEF1203-0LB</b>
75	100	1PE31-5 . LO	FSF	
90	125	1PE31-8 . LO	FSF	<b>JTA:TEF1203-0MB</b>
110	150	1PE32-1 . LO	FSF	
132	200	1PE32-5 . LO	FSF	
<b>500 ... 690 V 3 AC</b>				
11	10	1PH21-4 . LO	FSD	<b>JTA:TEF1203-0GB</b>
15	15	1PH22-0 . LO		
18.5	20	1PH22-3 . LO		
22	25	1PH22-7 . LO	FSD	<b>JTA:TEF1203-0HB</b>
30	30	1PH23-5 . LO		
37	40	1PH24-2 . LO		
45	50	1PH25-2 . LO	FSE	<b>JTA:TEF1203-0JB</b>
55	60	1PH26-2 . LO		
75	75	1PH28-0 . LO	FSF	<b>JTA:TEF1203-0KB</b>
90	100	1PH31-0 . LO		
110	100	1PH31-2 . LO	FSF	<b>JTA:TEF1203-0LB</b>
132	125	1PH31-4 . LO		
160	150	1PH31-7CLO	FSG	<b>JTA:TEF1203-0MB</b>
200	200	1PH32-1CLO		
250	250	1PH32-5CLO		



## SINAMICS G120 standard converters

0.37 kW to 250 kW (0.5 hp to 400 hp)

Load-side power components > dv/dt filters plus VPL

### Technical specifications

Line voltage 380 ... 480 V 3 AC or 500 ... 690 V 3 AC		dv/dt filters plus VPL (for rated pulse frequency 2 kHz – max. pulse frequency 4 kHz – max. output frequency 150 Hz)		
		JTA:TEF1203-0GB	JTA:TEF1203-0HB	JTA:TEF1203-0JB
<b>Rated current</b>	A	24	44	64
<b><math>I_{th\ max}</math></b>	A	38	70	104
<b>Power loss</b> at 150 Hz 690 V	kW	0.125	0.303	0.404
<b>Power connection</b> input and output side		Screw terminals	Screw terminals	Screw terminals
• Conductor cross-section, max.	mm <sup>2</sup>	16	35	50
<b>DC link connection <sup>1)</sup></b> DCPS, DCNS		Screw terminals	Screw terminals	Screw terminals
• Conductor cross-section, max.	mm <sup>2</sup>	16	16	16
<b>PE connection</b>		Screw terminals	Screw terminals	Screw terminals
• Conductor cross-section, max.	mm <sup>2</sup>	16	35	50
<b>Motor cable length, max.</b>				
• Shielded	m (ft)	350 (1148)	350 (1148)	350 (1148)
• Unshielded	m (ft)	525 (1723)	525 (1723)	525 (1723)
<b>Cable length, max.</b> between the dv/dt filter plus VPL and the Power Module	m (ft)	5 (16.4)	5 (16.4)	5 (16.4)
<b>Ambient temperature</b>	°C (°F)	-20 ... +40 (-4 ... +104) 40 ... 50 (104 ... 122) with current derating 1.5 % per 1 K 50 ... 60 (122 ... 140) with current derating 1.9 % per 1 K	-20 ... +40 (-4 ... +104) 40 ... 50 (104 ... 122) with current derating 1.5 % per 1 K 50 ... 60 (122 ... 140) with current derating 1.9 % per 1 K	-20 ... +40 (-4 ... +104) 40 ... 50 (104 ... 122) with current derating 1.5 % per 1 K 50 ... 60 (122 ... 140) with current derating 1.9 % per 1 K
<b>Degree of protection</b>		IP00	IP00	IP00
<b>Dimensions</b>				
• Width	mm (in)	264 (10.39)	264 (10.39)	310 (12.20)
• Height	mm (in)	260 (10.24)	275 (10.83)	375 (14.76)
• Depth	mm (in)	220 (8.66)	245 (9.65)	280 (11.02)
<b>Weight, approx.</b>	kg (lb)	20 (44.1)	29 (63.9)	46 (101)
<b>Conformity</b>		CE, UKCA	CE, UKCA	CE, UKCA
<b>Certificates of suitability</b>		cURus, EAC	cURus, EAC	cURus, EAC
<b>Suitable for PM240-2 Power Module standard variant 380 ... 480 V 3 AC</b>	Type	–	6SL3210-1PE23-8 . LO FSD	6SL3210-1PE24-5 . LO 6SL3210-1PE26-0 . LO FSD
<b>Suitable for PM240-2 Power Module 500 ... 690 V 3 AC</b>	Type	6SL3210-1PH21-4 . LO 6SL3210-1PH22-0 . LO 6SL3210-1PH22-3 . LO FSD	6SL3210-1PH22-7 . LO 6SL3210-1PH23-5 . LO 6SL3210-1PH24-2 . LO FSD	6SL3210-1PH25-2 . LO 6SL3210-1PH26-2 . LO FSE

<sup>1)</sup> Short-circuit-proof cables are required.

## SINAMICS G120 standard converters

0.37 kW to 250 kW (0.5 hp to 400 hp)

### Load-side power components > dv/dt filters plus VPL

#### Technical specifications

Line voltage 380 ... 480 V 3 AC or 500 ... 690 V 3 AC		dv/dt filters plus VPL (for rated pulse frequency 2 kHz – max. pulse frequency 4 kHz – max. output frequency 150 Hz)		
		JTA:TEF1203-0KB	JTA:TEF1203-0LB	JTA:TEF1203-0MB
<b>Rated current</b>	A	103	146	260
<b><math>I_{th\ max}</math></b>	A	160	230	416
<b>Power loss</b> at 150 Hz 690 V	kW	0.415	0.520	0.857
<b>Power connection</b> input and output side		Flat connector for M8 cable lug	Flat connector for M10 cable lug	Flat connector for M10 cable lug
• Conductor cross-section, max.	mm <sup>2</sup>	95	120	2 × 120 or 1 × 185
<b>DC link connection <sup>1)</sup></b> DCPS, DCNS		M8 cable lug	M8 cable lug	M8 cable lug
• Conductor cross-section, max.	mm <sup>2</sup>	25	25	50
<b>PE connection</b>		M6 screw studs	M6 screw studs	M6 screw studs
• Conductor cross-section, max.	mm <sup>2</sup>	50	70	95
<b>Motor cable length, max.</b>				
• Shielded	m (ft)	450/525 (1476/1723) <sup>2)</sup>	450/525 (1476/1723) <sup>2)</sup>	450/525 (1476/1723) <sup>2)</sup>
• Unshielded	m (ft)	650/800 (2133/2625) <sup>2)</sup>	650/800 (2133/2625) <sup>2)</sup>	650/800 (2133/2625) <sup>2)</sup>
<b>Cable length, max.</b> between the dv/dt filter plus VPL and the Power Module	m (ft)	5 (16.4)	5 (16.4)	5 (16.4)
<b>Ambient temperature</b>	°C (°F)	-20 ... +40 (-4 ... +104) 40 ... 50 (104 ... 122) with current derating 1.5 % per 1 K 50 ... 60 (122 ... 140) with current derating 1.9 % per 1 K	-20 ... +40 (-4 ... +104) 40 ... 50 (104 ... 122) with current derating 1.5 % per 1 K 50 ... 60 (122 ... 140) with current derating 1.9 % per 1 K	-20 ... +40 (-4 ... +104) 40 ... 50 (104 ... 122) with current derating 1.5 % per 1 K 50 ... 60 (122 ... 140) with current derating 1.9 % per 1 K
<b>Degree of protection</b>		IP00	IP00	IP00
<b>Dimensions</b>				
• Width	mm (in)	400 (15.75)	400 (15.75)	460 (18.11)
• Height	mm (in)	325 (12.80)	360 (14.17)	435 (17.13)
• Depth	mm (in)	355 (13.98)	380 (14.96)	445 (17.52)
<b>Weight, approx.</b>	kg (lb)	77 (170)	97 (214)	172 (379)
<b>Conformity</b>		CE, UKCA	CE, UKCA	CE, UKCA
<b>Certificates of suitability</b>		cURus, EAC	cURus, EAC	cURus, EAC
<b>Suitable for PM240-2 Power Module standard variant 380 ... 480 V 3 AC</b>	Type	6SL3210-1PE27-5 . LO FSD 6SL3210-1PE28-8 . LO FSE	6SL3210-1PE31-1 . LO FSE 6SL3210-1PE31-5 . LO FSF	6SL3210-1PE31-8 . LO 6SL3210-1PE32-1 . LO 6SL3210-1PE32-5 . LO FSF
<b>Suitable for PM240-2 Power Module 500 ... 690 V 3 AC</b>	Type	6SL3210-1PH28-0 . LO 6SL3210-1PH31-0 . LO FSF	6SL3210-1PH31-2 . LO 6SL3210-1PH31-4 . LO FSF	6SL3210-1PH31-7CLO 6SL3210-1PH32-1CLO 6SL3210-1PH32-5CLO FSG

<sup>1)</sup> Short-circuit-proof cables are required.

<sup>2)</sup> Maximum overvoltage at the motor terminals <1350 V with cable lengths up to 450 m (1476 ft) shielded or 650 m (2133 ft) unshielded – maximum overvoltage at the motor terminals <1500 V with cable lengths up to 525 m (1723 ft) shielded or 800 m (2625 ft) unshielded.

### Overview

Operator panel	IOP-2 and IOP-2 Handheld Intelligent Operator Panel	BOP-2 Basic Operator Panel
Description	 <p>Thanks to the high-contrast color display, menu-based operation and the wizards, commissioning of the standard drives is easy. Application wizards guide the user through the commissioning of important applications such as pumps, fans, compressors, or conveyor systems.</p>	 <p>Commissioning of standard drives is easy with the menu-prompted dialog on a 2-line display. Simultaneous display of the parameter and parameter value, as well as parameter filtering, means that basic commissioning of a drive can be performed easily and, in most cases, without a printed parameter list.</p>
Possible applications	<ul style="list-style-type: none"> <li>• Can be mounted directly on the converter</li> <li>• Can be mounted in a control cabinet door using a door mounting kit (achievable degree of protection is IP55/UL Type 12 enclosure)</li> <li>• The environmental class/harmful chemical substances is Class 3C3 acc. to IEC 60721-3-3: 2002</li> <li>• Available as handheld version</li> <li>• <b>The following languages are integrated in the IOP-2: English, German, French, Italian, Spanish, Portuguese, Dutch, Swedish, Finnish, Russian, Czech, Polish, Turkish, Chinese Simplified</b></li> </ul>	<ul style="list-style-type: none"> <li>• Can be mounted directly on the converter</li> <li>• Can be mounted in the control cabinet door using a door mounting kit (achievable degree of protection is IP55/UL Type 12)</li> <li>• The environmental class/harmful chemical substances is Class 3C3 acc. to IEC 60721-3-3: 2002</li> </ul>
Quick commissioning without expert knowledge	<ul style="list-style-type: none"> <li>• Standard commissioning using the clone function</li> <li>• For quicker access, the parameter block names can be directly entered respectively changed on the IOP-2 using the virtual keyboard.</li> <li>• User-defined parameter list with a reduced number of self-selected parameters</li> <li>• Simple commissioning of standard applications using Quick Startup and Advanced Startup, it is not necessary to know the parameter structure</li> <li>• Simple local commissioning using the handheld version</li> <li>• Commissioning is possible largely without documentation</li> </ul>	<ul style="list-style-type: none"> <li>• Standard commissioning using the clone function</li> </ul>
High degree of operator friendliness and intuitive operation	<ul style="list-style-type: none"> <li>• Intuitive navigation by operating with a sensor control field</li> <li>• Graphic color display to show status values such as pressure or flow rate in the form of scalar values, bar-type diagrams, or trend displays</li> <li>• Status display with freely selectable units to specify physical values</li> <li>• Direct manual operation of the drive – you can simply toggle between the automatic and manual modes</li> <li>• Simple cloning of specific settings of the IOP-2 user interface.</li> </ul>	<ul style="list-style-type: none"> <li>• 2-line display for showing up to 2 process values with text</li> <li>• Status display of predefined units</li> <li>• Direct manual operation of the drive – you can simply toggle between the automatic and manual modes</li> </ul>
Minimization of maintenance times	<ul style="list-style-type: none"> <li>• Diagnostics using plain text display, can be used locally on-site without documentation</li> <li>• The support function is used to determine the drive data for the Power Module, Control Unit and IOP-2 and makes this available as a two-dimensional code (data matrix/QR code)</li> <li>• Easily upgradable to new functional status via USB interface</li> </ul>	<ul style="list-style-type: none"> <li>• Diagnostics with menu prompting with 7-segment display</li> </ul>

## SINAMICS G120 standard converters

0.37 kW to 250 kW (0.5 hp to 400 hp)

### Supplementary system components > IOP-2 Intelligent Operator Panel

#### Overview

##### *IOP-2 Intelligent Operator Panel*



IOP-2 Intelligent Operator Panel

The Intelligent Operator Panel IOP-2 is a very user-friendly and powerful Operator Panel for SINAMICS G120, SINAMICS G120C, SINAMICS G120P, SINAMICS G120X, SINAMICS G120D and SIMATIC ET 200pro FC-2.

The IOP-2 supports both newcomers and drive experts. Thanks to the membrane keyboard with a central sensor control field, high-contrast color displays, menu-based operation, and simple setup processes for which no specialized drive know-how is required, commissioning of drives is easy. The IOP-2 update (V2.3 and higher) offers a new concept for faster and simpler commissioning of the drive.

Within minutes, Quick Startup provides an overview of the basic parameters needed to commission and operate the drive. Advanced Startup supports simpler commissioning of more complex applications and displays the parameters in a single screen so that you no longer have to switch between the different areas in the IOP-2.

Advanced Setup generates a list of categories that guides the user by changing the status icons of categories when they are changed. Also, a drive can essentially be commissioned without having to use a printed parameter list because the parameters are displayed in plain text and explanatory help texts and parameter filtering function are provided.

Two process values can be graphically visualized and four process values can be numerically visualized on the status screen. Process values can also be displayed in technological units.

The IOP-2 supports standard commissioning of identical drives. For this purpose, a parameter list can be copied from a converter into the IOP-2 and downloaded into other drive units of the same type as required.

The IOP-2 can also use a text editor to create a user-defined parameter list and download it directly to the frequency converter using the IOP-2 download process.

The IOP-2 can be installed in control cabinet doors using the optionally available door mounting kit.

##### Updating the IOP-2

The IOP-2 can be updated and expanded using the integrated USB interface.

Data to support future drive systems can be transferred from the PC to the IOP-2. Further, the USB interface allows user languages and wizards that will become available in the future to be subsequently downloaded and the firmware to be updated for the IOP-2<sup>1)</sup>.

The IOP-2 is supplied with power via the USB interface during an update.

##### **IOP-2 Handheld**



IOP-2 Handheld

A handheld version of the IOP-2 can be ordered for mobile use. In addition to the IOP-2, it includes a housing with rechargeable batteries, a charging unit, an RS232 connecting cable, and a USB cable. The charging unit is supplied with connector adapters for Europe, the US and UK. When the batteries are fully charged, the operating time is up to 10 hours.

To connect the IOP-2 Handheld to SINAMICS G120D and SIMATIC ET 200pro FC-2, the RS232 connecting cable with optical interface is required in addition.

<sup>1)</sup> Information about updates for the IOP-2 is available at <https://support.industry.siemens.com/cs/document/67273266>

## SINAMICS G120 standard converters

0.37 kW to 250 kW (0.5 hp to 400 hp)

### Supplementary system components > IOP-2 Intelligent Operator Panel

#### Selection and ordering data

Description	Article No.
<p><b>IOP-2 Intelligent Operator Panel</b></p> <p>For use with            SINAMICS G120            SINAMICS G120C            SINAMICS G120P            SINAMICS G120X            SINAMICS G120D            SIMATIC ET 200pro FC-2</p> <p>Operating languages: English, German, French, Italian, Spanish, Portuguese, Dutch, Swedish, Finnish, Russian, Czech, Polish, Turkish, Chinese Simplified</p>	<b>6SL3255-0AA00-4JA2</b>
<p><b>IOP-2 Handheld</b></p> <p>For use with            SINAMICS G120            SINAMICS G120C            SINAMICS G120P            SINAMICS G120X            SINAMICS G120D            SIMATIC ET 200pro FC-2</p> <p>Included in the scope of delivery:</p> <ul style="list-style-type: none"> <li>• IOP-2</li> <li>• Handheld housing</li> <li>• Rechargeable batteries (4 x AA)</li> <li>• Charging unit (international)</li> <li>• RS232 connecting cable <sup>1)</sup>            3 m (9.84 ft) long,            can be used in combination with            SINAMICS G120            SINAMICS G120C            SINAMICS G120P            SINAMICS G120X</li> <li>• USB cable            1 m (3.28 ft) long</li> </ul>	<b>6SL3255-0AA00-4HA1</b>
<b>Accessories</b>	
<p><b>Door mounting kit</b></p> <p>For mounting an Operator Panel in control cabinet doors with sheet steel thicknesses of 1 ... 3 mm (0.04 in ... 0.12 in)            Degree of protection IP55            Included in the scope of delivery:</p> <ul style="list-style-type: none"> <li>• Seal</li> <li>• Fixing accessories</li> <li>• Connecting cable            5 m (16.4 ft) long,            also supplies voltage to the IOP-2 directly via the converter</li> </ul>	<b>6SL3256-0AP00-0JA0</b>
<p><b>RS232 connecting cable</b></p> <p>2.5 m (8.20 ft) long,            with optical interface for connecting the IOP-2 Handheld to            SINAMICS G120D            SIMATIC ET 200pro FC-2</p>	<b>3RK1922-2BP00</b>

#### Benefits

- New device design
  - Intuitive user interface – membrane keyboard with central sensor control field
  - High-contrast color display with a range of display options
  - IOP-2 device design open for future functional expansions (e.g. device functions, commissioning setups, languages)
  - Easily upgradable to new functional status via USB interface
- Commissioning
  - Simple commissioning using Quick Startup and Advanced Startup
  - Quick Startup gives the user simple and fast access to all the basic parameters required to commission simple applications.
  - Advanced Startup provides the parameters required to commission more complex applications, dispensing with the need to switch between different areas within the IOP-2.
  - I/O Setup supports fast and simple configuration of digital and analog inputs and outputs.
  - Fieldbus Setup is provided for simple configuration of EtherNet/IP and PROFINET interface protocols.
  - Fast standard commissioning of converters thanks to cloning function
  - For quicker access, the parameter block names can be directly entered or changed on the IOP-2 via the virtual keyboard. Extended help functions provide support for the user during commissioning.
  - Simple local commissioning on-site using the handheld version
- Operator control and monitoring
  - Simple, individual local drive control (start/stop, setpoint value specification, change in direction of rotation)
  - Application-specific scenarios such as operator concepts with additional external operating elements can be implemented easily
  - Simple cloning of specific settings of the IOP-2 user interface, such as status screen, language settings, lighting duration, date/time settings, parameter backup mode and "My Parameters" - settings made once can such be easily transferred to many further IOP-2 Intelligent Operator Panels
  - Simple creation of a user-defined parameter list and direct download to the frequency converter using the IOP-2 download process.
- Diagnostics
  - Rapid diagnostics thanks to on-site plain text display
  - Integrated plain text help function for local display and resolution of fault messages
- Support function
  - Used to determine the drive data for the Power Module, Control Unit and IOP-2 (article number, serial number, firmware version, error statuses) and makes this available as a two-dimensional code (data matrix/QR code)
  - Allows easy contact with Customer Support via a data matrix/QR code generated on the IOP-2
  - Quick access via mobile devices (e.g. smartphones, tablets) to product information, documentation, FAQs, contact persons via a two-dimensional code generated on the IOP-2 (data matrix/QR code)
  - Scanning and evaluating of the two-dimensional data matrix code using the Industry Online Support app (<https://support.industry.siemens.com/cs/ww/en/sc/2067>), see also: <https://support.industry.siemens.com/cs/document/109748340>

<sup>1)</sup> For use in conjunction with SINAMICS G120D and SIMATIC ET 200pro FC-2, the RS232 connecting cable with optical interface is required (Article No.: **3RK1922-2BP00**). The cable must be ordered separately.

## SINAMICS G120 standard converters

0.37 kW to 250 kW (0.5 hp to 400 hp)

### Supplementary system components > IOP-2 Intelligent Operator Panel

#### Integration

##### Using the IOP-2 with the converters

	<ul style="list-style-type: none"> <li>SINAMICS G120 with CU230P-2, CU240E-2 or CU250S-2</li> <li>SINAMICS G120C</li> <li>SINAMICS G120P with CU230P-2</li> <li>SINAMICS G120X</li> </ul>	<ul style="list-style-type: none"> <li>SINAMICS G120D</li> <li>SIMATIC ET 200pro FC-2</li> </ul>
<b>Plugging the IOP-2 onto the converter</b> (power supply via converter)	✓	–
<b>Door mounting of the IOP-2 with the door mounting kit</b> (Power supply via converter. For this purpose, the IOP-2 must be connected up by means of the connecting cable supplied with the door mounting kit.)	✓	–
<b>Mobile use of the IOP-2 Handheld</b> (power supply via rechargeable batteries)	✓	✓ (RS232 connecting cable with optical interface required, article number 3RK1922-2BP00)

#### Door mounting

Using the optionally available door mounting kit, an Operator Panel can be simply mounted in a control cabinet door with just a few manual operations. In the case of door mounting, the IOP-2 Operator Panel achieves degree of protection IP55/UL Type 12 enclosure.

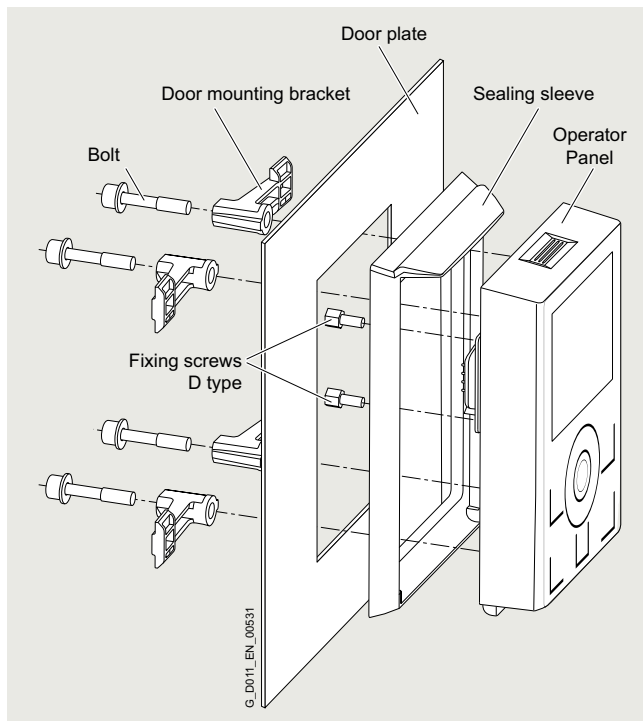

Door mounting kit with plugged-on IOP-2

#### Technical specifications

	IOP-2 6SL3255-0AA00-4JA2	IOP-2 Handheld 6SL3255-0AA00-4HA1
<b>Display</b>	High-contrast color display, a variety of display options	
• Resolution	320 × 240 pixels	
<b>Operator panel</b>	Membrane keyboard with central sensor control field	
<b>Operating languages</b>	English, German, French, Italian, Spanish, Portuguese, Dutch, Swedish, Finnish, Russian, Czech, Polish, Turkish, Chinese Simplified	
<b>Ambient temperature</b>	<ul style="list-style-type: none"> <li>During storage and transport</li> <li>During operation</li> </ul>	
	-40 ... +70 °C (-40 ... +158 °F)	-20 ... +55 °C (-4 ... +131 °F)
	For direct mounting on the converter: 0 ... 50 °C (32 ... 122 °F)	0 ... 40 °C (32 ... 104 °F)
	For installation with door mounting kit: 0 ... +55 °C (32 ... 131 °F)	
<b>Humidity</b>	Relative humidity < 95 %, non-condensing	
<b>Degree of protection</b>	For direct mounting on the converter: IP20  For installation with door mounting kit: IP55, UL Type 12 enclosure	IP20
<b>Dimensions (H × W × D)</b>	106.86 × 70 × 19.65 mm (4.21 × 2.76 × 0.77 in)	195.04 × 70 × 37.58 mm (7.68 × 2.76 × 1.48 in)
<b>Weight, approx.</b>	0.134 kg (0.3 lb)	0.724 kg (1.6 lb)
<b>Compliance with standards</b>	CE, UKCA, RCM, cULus, EAC, KC-REM-S49-SINAMICS	
<b>Environmental class in operation</b>	Harmful chemical substances Class 3C3 acc. to IEC 60721-3-3: 2002	

## SINAMICS G120 standard converters

0.37 kW to 250 kW (0.5 hp to 400 hp)

### Supplementary system components > BOP-2 Basic Operator Panel

#### Overview



BOP-2 Basic Operator Panel

The BOP-2 Basic Operator Panel can be used to commission drives, monitor drives in operation and input individual parameter settings.

Commissioning of standard drives is easy with the menu-prompted dialog on a 2-line display. Simultaneous display of the parameter and parameter value, as well as parameter filtering, means that basic commissioning of a drive can be performed easily and, in most cases, without a printed parameter list.

The drives are easily controlled manually using directly assigned navigation buttons. The BOP-2 has a dedicated switchover button to switch from automatic to manual mode.

Diagnostics can easily be performed on the connected converter by following the menus.

Up to two process values can be numerically visualized simultaneously.

BOP-2 supports standard commissioning of identical drives. For this purpose, a parameter list can be copied from a converter into the BOP-2 and when required, downloaded into other drive units of the same type.

The operating temperature of the BOP-2 is 0 °C ... 50 °C (32 °F ... 122 °F).

The environmental class/harmful chemical substances of the BOP-2 is Class 3C3 acc. to IEC 60721-3-3: 2002.

#### Selection and ordering data

Description	Article No.
<b>BOP-2 Basic Operator Panel</b>	<b>6SL3255-0AA00-4CA1</b>
<b>Accessories</b>	
<b>Door mounting kit</b>	<b>6SL3256-0AP00-0JA0</b>
For mounting an operator panel in control cabinet doors with sheet steel thicknesses of 1 ... 3 mm (0.04 ... 0.12 in) Degree of protection IP55	
Included in the scope of delivery:	
<ul style="list-style-type: none"> <li>• Seal</li> <li>• Mounting material</li> <li>• Connecting cable (5 m (16.4 ft) long, also supplies voltage to the operator panel directly via the converter)</li> </ul>	

#### Benefits

- Shorten commissioning times – Easy commissioning of standard drives using basic commissioning wizards (setup)
- Minimize standstill times – Fast detection and rectification of faults (Diagnostics)
- Greater transparency in the process – The status display of the BOP-2 makes process variable monitoring easy (Monitoring)
- Direct mounting on the converter
- User-friendly user interface:
  - Easy navigation using clear menu structure and clearly assigned control keys
  - Two-line display

## SINAMICS G120 standard converters

0.37 kW to 250 kW (0.5 hp to 400 hp)

### Supplementary system components > BOP-2 Basic Operator Panel

#### Integration

##### Using the BOP-2 with SINAMICS G120 converters

	CU230P-2	CU240E-2	CU250S-2
Plugging the BOP-2 onto the converter	✓	✓	✓
Door mounting with door mounting kit	✓	✓	✓

#### Door mounting

Using the optionally available door mounting kit, a BOP-2 can be simply mounted in a control cabinet door with just a few manual operations. Degree of protection IP55 is achieved for door mounting.

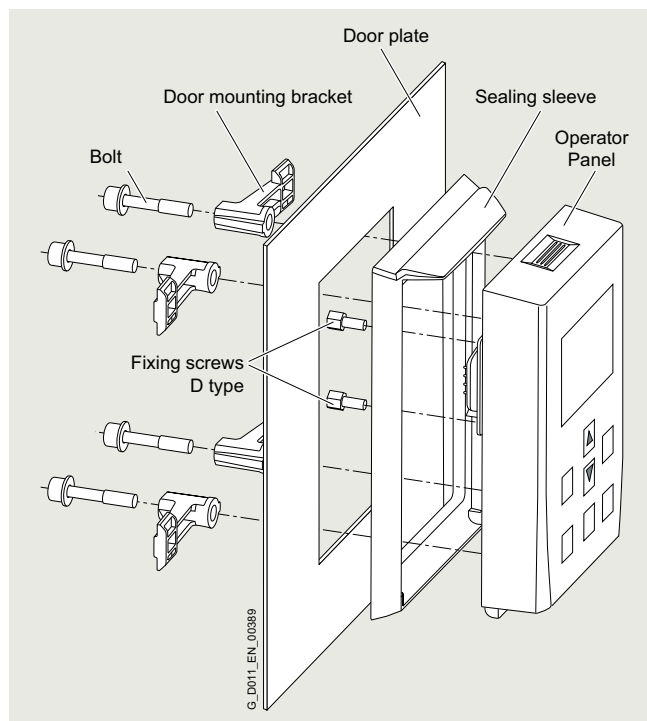

Door mounting kit with plugged-on BOP-2



## SINAMICS G120 standard converters

0.37 kW to 250 kW (0.5 hp to 400 hp)

### Supplementary system components > Memory cards

#### Overview



SINAMICS SD memory card

The parameter settings for a converter can be stored on the SINAMICS SD memory card. When service is required, e.g. after the converter has been replaced and the data have been downloaded from the memory card, the drive system is immediately ready for use again.

- Parameter settings can be written from the memory card to the converter or saved from the converter to the memory card.
- Up to 100 parameter sets can be stored.
- The memory card supports standard commissioning without the use of an operator panel such as the IOP-2, BOP-2 or the STARTER and SINAMICS Startdrive commissioning tools.
- If firmware is stored on the memory card and a Control Unit is installed, the firmware can be upgraded/downgraded during power-up <sup>1)</sup>.

#### Note:

The memory card is not required for operation and does not have to remain inserted.

Licenses can be optionally ordered for CU250S-2 Control Units in order to implement safety technology and positioning capability via the SINAMICS SD card. [For further information, refer to section Control Units.](#)

#### Selection and ordering data

Description	Article No.
<b>SINAMICS SD card 512 MB</b>	<b>6SL3054-4AG00-2AA0</b>
<b>Optional firmware memory cards</b>	
<b>SINAMICS SD card 512 MB + firmware V4.7 SP13</b> (Multicard V4.7 SP13)	<b>6SL3054-7TG00-2BA0</b>
<b>SINAMICS SD card 512 MB + firmware V4.7 SP14</b> (Multicard V4.7 SP14)	<b>6SL3054-7TH00-2BA0</b>

More information on firmware V4.7 SP14:

<https://support.industry.siemens.com/cs/document/109817231>

For an overview and more information on all available firmware versions, see

<https://support.industry.siemens.com/cs/document/67364620>

<sup>1)</sup> You can find more information about firmware upgrades/downgrades on the internet at <https://support.industry.siemens.com/cs/document/67364620>

## SINAMICS G120 standard converters

0.37 kW to 250 kW (0.5 hp to 400 hp)

### Supplementary system components > SINAMICS G120 Smart Access

#### Overview



SINAMICS G120 Smart Access

It is also easy and convenient to commission and operate the SINAMICS G115D, SINAMICS G120, SINAMICS G120C, SINAMICS G120P and SINAMICS G120X frequency converters of firmware V4.7 SP6 and higher using the web server module SINAMICS G120 Smart Access and a connected smartphone, tablet or laptop.

#### Integration



SINAMICS G120 with PM240-2 Power Module, CU240E-2 PN-F Control Unit and plugged-on SINAMICS G120 Smart Access

The optional SINAMICS G120 Smart Access is simply plugged onto the converter and is available for the following converters of firmware V4.7 SP6 and higher:

- SINAMICS G115D together with the interface kit for SINAMICS G120 Smart Access
- SINAMICS G120C
- SINAMICS G120 together with the CU230P-2 and CU240E-2 Control Units (without fail-safe versions)
- SINAMICS G120P together with the CU230P-2 Control Units
- SINAMICS G120X

#### Benefits

- Wireless commissioning, operation and diagnostics via mobile device or laptop thanks to the optional SINAMICS G120 Smart Access
- Intuitive user interface and commissioning wizard
- Free choice of terminal devices as the web server works with all common web browsers, such as iOS, Android, Microsoft Windows, Linux and Mac OS

#### Function

- Commissioning using commissioning wizard
- Setting and saving parameters
- Testing motor in JOG mode
- Monitoring of converter data
- Quick diagnostics
- Saving the settings and restoring to factory settings

#### Selection and ordering data

Description	Article No.
<b>SINAMICS G120 Smart Access</b> For wireless commissioning, operation and diagnostics of the following converters using a smartphone, tablet, or laptop	<b>6SL3255-0AA00-5AA0</b>
<ul style="list-style-type: none"> <li>• SINAMICS G115D together with the interface kit for SINAMICS G120 Smart Access</li> </ul>	
<ul style="list-style-type: none"> <li>• SINAMICS G120C</li> </ul>	
<ul style="list-style-type: none"> <li>• SINAMICS G120 together with the CU230P-2 and CU240E-2 Control Units (without fail-safe versions)</li> </ul>	
<ul style="list-style-type: none"> <li>• SINAMICS G120P together with the CU230P-2 Control Units</li> </ul>	
<ul style="list-style-type: none"> <li>• SINAMICS G120X</li> </ul>	

#### Technical specifications

	<b>SINAMICS G120 Smart Access</b> 6SL3255-0AA00-5AA0	
<b>Operating system</b>	iOS, Android, Microsoft Windows, Linux, Mac OS	
<b>Languages</b>	Support of six languages: English, French, German, Italian, Spanish, Chinese	
<b>Ambient temperature</b>	<ul style="list-style-type: none"> <li>• During storage and transport -40 ... +70 °C (-40 ... +158 °F)</li> <li>• During operation 0 ... 50 °C (32 ... 122 °F) if the Smart Access Module is plugged directly into the converter</li> </ul>	
<b>Humidity</b>		< 95 %, non-condensing
<b>Degree of protection</b>	Depending on the degree of protection of the converter, max. IP55/UL Type 12 enclosure	
<b>Dimensions</b>	<ul style="list-style-type: none"> <li>• Width 70 mm (2.76 in)</li> <li>• Height 108.9 mm (4.29 in)</li> <li>• Depth 17.3 mm (0.68 in)</li> </ul>	
<b>Weight, approx.</b>		0.08 kg (0.18 lb)
<b>Compliance with standards</b>		CE, UKCA, FCC, SRR, WPC, ANATEL, BTK

# SINAMICS G120 standard converters

0.37 kW to 250 kW (0.5 hp to 400 hp)

## Supplementary system components > Brake Relay

### Overview



The Brake Relay allows the Power Module to be connected to an electromechanical motor brake, thereby allowing the motor brake to be driven directly by the Control Unit.

### Selection and ordering data

Description	Article No.
<b>Brake Relay</b> Including cable harness for connection with the Power Module	<b>6SL3252-0BB00-0AA0</b>

### Technical specifications

Brake Relay	
	6SL3252-0BB00-0AA0
<b>Switching capability of the NO contact, general purpose</b>	250 V AC / 16 A 30 V DC / 12 A
<b>Conductor cross-section, max.</b>	2.5 mm <sup>2</sup>
<b>Degree of protection</b>	IP20
<b>Dimensions</b>	
• Width	68 mm (2.68 in)
• Height	63 mm (2.48 in)
• Depth	33 mm (1.30 in)
<b>Weight, approx.</b>	0.17 kg (0.37 lb)

### Integration

The Brake Relay has the following interfaces:

- A switch contact (NO contact) to control the motor brake solenoid
- A connection for the cable harness (CTRL) for connection to the Power Module

The Brake Relay can be installed on the shield connection plate near the power terminals of the Power Module.

The scope of supply of a Brake Relay includes the following:

- 4 cable harnesses for connecting to the CTRL socket of the Power Module
  - Length 0.32 m (1.05 ft) for frame sizes FSA to FSC
  - Length 0.55 m (1.80 ft) for frame sizes FSD and FSE
  - Length 0.8 m (2.62 ft) for frame size FSF
  - Length 1.1 m (3.61 ft) for frame size FSG

The 24 V DC solenoid of the motor brake is connected via an external power supply. For 24 V DC, external surge suppressors are required (e.g. varistor, transil diode).

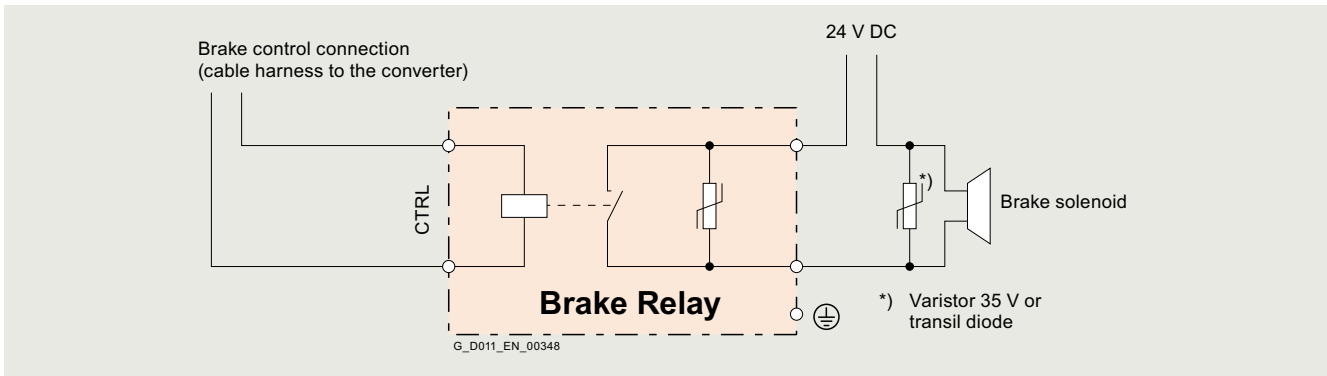

Connection example of 24 V DC Brake Relay

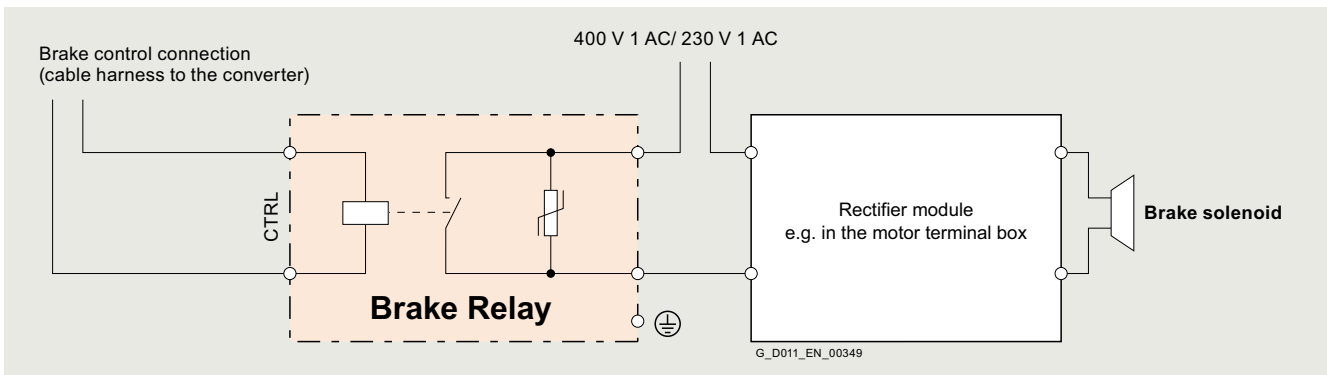

Connection example of 230 ... 400 V 1 AC Brake Relay

## SINAMICS G120 standard converters

0.37 kW to 250 kW (0.5 hp to 400 hp)

### Supplementary system components > Safe Brake Relay for blocksize format

#### Overview



Safe Brake Relay

With the Safe Brake Relay, the brake is controlled in accordance with IEC 61508 SIL 2 and EN ISO 13849-1 PL d and Category 3.

#### Design

The Safe Brake Relay can be installed below the Power Module on the shield connection plate.

The Safe Brake Relay has the following connections and interfaces:

- 1 two-channel transistor output stage to control the motor brake solenoid
- 1 connection for the cable harness (CTRL) to the Power Module in blocksize format
- 1 connection for the 24 V DC power supply

The connection between the 24 V DC power supply and the Safe Brake Relay must be kept as short as possible.

The scope of supply of a Safe Brake Relay includes the following:

- 4 cable harnesses for connecting to the CTRL socket of the Power Module
  - Length 0.32 m (1.05 ft) for frame sizes FSA to FSC
  - Length 0.55 m (1.80 ft) for frame sizes FSD and FSE
  - Length 0.8 m (2.62 ft) for frame size FSF
  - Length 1.1 m (3.61 ft) for frame size FSG

#### Selection and ordering data

Description	Article No.
<b>Safe Brake Relay</b> Including cable harness for connection to Power Module	<b>6SL3252-0BB01-0AA0</b>

#### Technical specifications

Safe Brake Relay	
6SL3252-0BB01-0AA0	
<b>Power supply</b>	20.4 ... 28.8 V DC Recommended rated supply voltage 26 V DC (to compensate for voltage drop in feeder cable to 24 V DC motor brake solenoid)
<b>Current requirement, max.</b>	<ul style="list-style-type: none"> <li>• Motor brake: 2.5 A</li> <li>• At 24 V DC: 0.05 A + the current requirement of motor brake</li> </ul>
<b>Conductor cross-section, max.</b>	2.5 mm <sup>2</sup>
<b>Dimensions</b>	<ul style="list-style-type: none"> <li>• Width: 69 mm (2.72 in)</li> <li>• Height: 63 mm (2.48 in)</li> <li>• Depth: 33 mm (1.30 in)</li> </ul>
<b>Weight, approx.</b>	0.17 kg (0.37 lb)

9

#### Integration

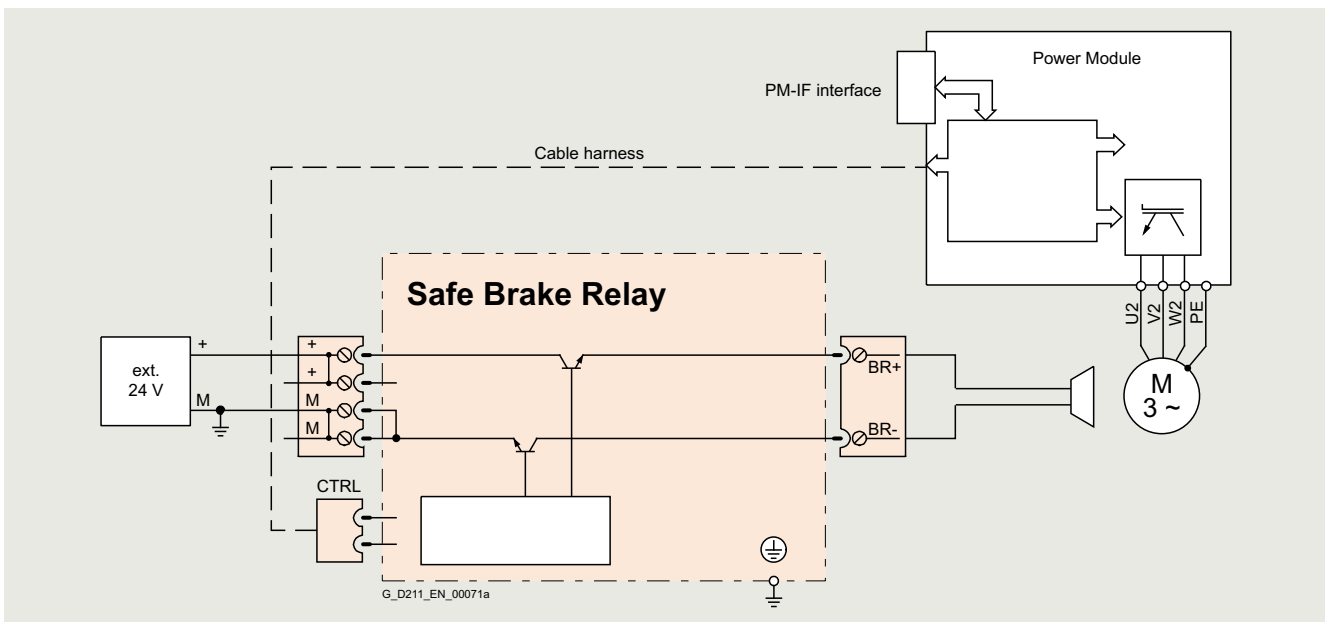

Connection example of a Safe Brake Relay

The 24 V DC solenoid of the motor brake is directly connected to the Safe Brake Relay. External overvoltage limiters are not required.

## SINAMICS G120 standard converters

0.37 kW to 250 kW (0.5 hp to 400 hp)

### Supplementary system components > SINAMICS CUA20 Control Unit Adapter

#### Overview

The SINAMICS CUA20 Control Unit Adapter kit is an additional option for simple and flexible cabinet configuration. By simply installing it to the left or right of the PM240-2 Power Module, the Adapter kit facilitates control cabinet configurations where the Power Module and Control Unit have to be thermally separated.

The SINAMICS CUA20 Control Unit Adapter kit consists of the following components:

- Power Module Interface (PM-IF) Adapter that is snapped on to the Power Module
- Adapter for the Control Unit
- Cable with integrated connectors for connecting the two adapters

The SINAMICS CUA20 Control Unit Adapter kit is compatible with the following SINAMICS Control Units of the SINAMICS G120 converter range:

- CU230P-2
- CU240E-2
- CU250S-2

#### Benefits

- Simple optional expansion of the SINAMICS G120 converter series for alternative cabinet configurations
- Makes DNV-GL-certified cabinet configurations possible
- Makes cabinet configurations possible in which the Power Module and Control Unit have to be thermally separated.

#### Selection and ordering data

Description	Article No.
<b>SINAMICS CUA20 Control Unit Adapter</b>	<b>6SL3255-0BW01-0NA0</b>

#### Technical specifications

	CUA20 Control Unit Adapter kit 6SL3255-0BW01-0NA0
<b>Ambient conditions</b>	
• Ambient temperature	-20 ... +60 °C (-4 ... + 140 °F)
• Shock and vibration	
- Transport according to EN 60721-3-2	2M3
- Operation acc. to EN 60721-3-3	3M1
• Protection against chemical substances according to EN 60721-3-2	2C2
<b>Length, connecting cable</b>	1.5 m (4.92 ft)
<b>Weight, approx.</b>	1.032 kg (2.276 lb)
<b>Compliance with standards</b>	CE, UL, TÜV, EAC, RCM

#### More information

Detailed technical information about the SINAMICS CUA20 Control Unit Adapter is available on the internet at:  
<https://support.industry.siemens.com/cs/document/109775484>

### Supplementary system components > PC converter connection kit 2

#### Overview



PC converter connection kit 2

For controlling and commissioning a converter directly from a PC if a commissioning tool (e.g. SINAMICS Startdrive) has been installed on the PC. With this, the converter can be

- parameterized (commissioning, optimization)
- monitored (diagnostics)
- controlled (master control via the commissioning tool for test purposes)

A USB cable (3 m/9.84 ft) is included in the scope of delivery.

The PC converter connection kit 2 is compatible with the following Control Units and converters (all communication methods):

- SINAMICS G120C
- SINAMICS G120 Control Units
  - CU230P-2
  - CU240E-2
  - CU250S-2
- SINAMICS G115D
- SINAMICS G120D Control Units
  - CU240D-2
  - CU250D-2

#### Selection and ordering data

Description	Article No.
<b>PC converter connection kit 2</b>	<b>6SL3255-0AA00-2CA0</b>
USB cable (3 m/9.84 ft long) for	
• SINAMICS G120C	
• SINAMICS G120 Control Units	
- CU230P-2	
- CU240E-2	
- CU250S-2	
• SINAMICS G115D	
• SINAMICS G120D Control Units	
- CU240D-2	
- CU250D-2	

## SINAMICS G120 standard converters

0.37 kW to 250 kW (0.5 hp to 400 hp)

### Supplementary system components > Shield connection kits for Control Units

#### Overview

The shield connection kit offers for all signal and communication cables

- Optimum shield connection
- Strain relief

A shield connection kit contains the following:

- A matching shield connection plate
- All of the necessary connecting and retaining elements for mounting

The shield connection kits are suitable for the following SINAMICS G120 Control Units:

- CU230P-2
- CU240E-2
- CU250S-2

#### Selection and ordering data

Description	Article No.
<b>Shield connection kit 1</b> For CU230P-2 HVAC and CU230P-2 DP Control Units	<b>6SL3264-1EA00-0FA0</b>
<b>Shield connection kit 2</b> For the CU240E-2 Control Unit	<b>6SL3264-1EA00-0HA0</b>
<b>Shield connection kit 3</b> for CU230P-2 PN, CU240E-2 PN and CU240E-2 PN-F Control Units	<b>6SL3264-1EA00-0HB0</b>
<b>Shield connection kit 4</b> for CU250S-2 Control Units	<b>6SL3264-1EA00-0LA0</b>

### Supplementary system components > Shield connection kits for Power Modules

#### Overview

The shield connection kit

- makes it easier to connect the shields of supply and control cables
- provides mechanical strain relief
- ensures optimum EMC performance
- is used to attach the Brake Relay

The shield connection kit includes

- a shield connection plate for the required Power Module
- connection elements and clamps for mounting
- mounting device for Brake Relay, frame sizes FSD to FSG

A shield connection kit is supplied as standard with PM240-2 Power Modules in frame sizes FSA to FSC.

A set of shield plates is included in the scope of delivery for the motor and signal cables corresponding to the frame size for the frame sizes FSD to FSG. For the electromagnetically compatible connection of an optionally connectable braking resistor, the corresponding shield connection kit is to be ordered for frame sizes FSD to FSG.

#### Selection and ordering data

Description	Article No.
<b>Shield connection kit</b> for PM240-2 Power Modules	Supplied with the Power Modules, available as a spare part
• Frame sizes FSA to FSC	
• Frame sizes FSD to FSG	
• A set of shield plates is included in the scope of delivery for the motor and signal cables corresponding to the frame size. For the electromagnetically compatible connection of an optionally connectable braking resistor, the corresponding shield connection kit is to be ordered.	
• Frame size FSD	
• Frame size FSE	<b>6SL3262-1AD01-0DA0</b>
• Frame size FSE	<b>6SL3262-1AE01-0DA0</b>
• Frame size FSF	<b>6SL3262-1AF01-0DA0</b>
• Frame size FSG	<b>6SL3262-1AG01-0DA0</b>
<b>Shield connection kit</b> for PM250 Power Modules	
• Frame size FSC	<b>6SL3262-1AC00-0DA0</b>
• Frame sizes FSD and FSE	<b>6SL3262-1AD00-0DA0</b>
• Frame size FSF	<b>6SL3262-1AF00-0DA0</b>

## SINAMICS G120 standard converters

0.37 kW to 250 kW (0.5 hp to 400 hp)

### Supplementary system components > Wiring adapter for frame size FSG

#### Overview

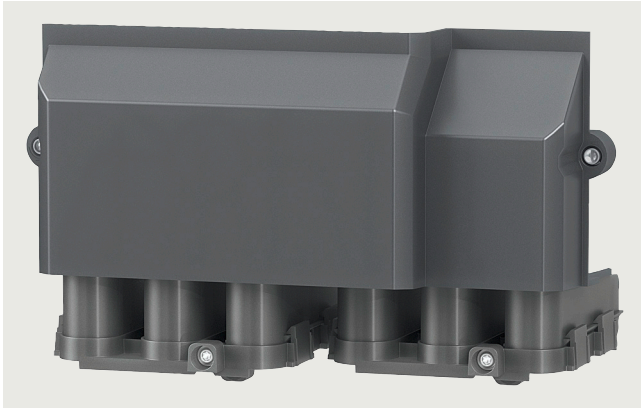

Wiring adapter for frame size FSG

The wiring adapter enables optimal and space-saving wiring of frame size FSG for SINAMICS G120 PM240-2 Power Modules and SINAMICS G120X.

Smaller bending radii help where mounting space is constricted: Up to four smaller cables (with a cross section of 120 mm<sup>2</sup> each) can be routed with the adapter for connection to the line supply and to the motor. All cables can be connected on the underside of the adapter, which allows for easy and space-saving wiring.

The scope of delivery of the wiring adapter includes contacts, nuts, a cover and various small components.

#### Selection and ordering data

Description	Article No.
<b>Wiring adapter for frame size FSG</b> for optimal and space-saving wiring of SINAMICS G120 PM240-2 Power Modules and SINAMICS G120X	<b>6SL3266-2HG00-0BA0</b>

#### Integration



SINAMICS G120 frame size FSG with wiring adapter (and cable outlet)

Further documentation on SINAMICS G120 is available free on the internet at:

[www.siemens.com/sinamics-g120/documentation](http://www.siemens.com/sinamics-g120/documentation)

Further documentation on SINAMICS G120X is available free on the internet at:

[www.siemens.com/sinamics-g120x/documentation](http://www.siemens.com/sinamics-g120x/documentation)

## SINAMICS G120 standard converters

0.37 kW to 250 kW (0.5 hp to 400 hp)

### Spare parts > Spare parts kit for Control Units

#### Overview

The spare parts kit contains small parts for all variants of the following SINAMICS G120 Control Units:

- CU230P-2
- CU240E-2
- CU240E-2 F
- CU250S-2

Included in the scope of delivery:

- Label set for all variants of the CU230P-2, CU240E-2, CU240E-2 F and CU250S-2 Control Units
- 2 × replacement doors (top/bottom)
- 2 × labeling strips for use on the doors
- 1 × 4, 5, 6, 7, 8, 9, 10 and 11-pole terminal blocks
- 1 × protective element for memory card slot
- 1 × screw for SUB-D interface

#### Selection and ordering data

Description	Article No.
<b>Spare parts kit for Control Units</b> CU230P-2, CU240E-2, CU240E-2 F and CU250S-2	<b>6SL3200-0SK01-0AA0</b>

### Spare parts > Shield connection kits for PM240-2 Power Modules

#### Overview

A shield connection kit is supplied as standard with PM240-2 Power Modules (and SINAMICS G120C) in frame sizes FSA to FSC. These shield connection kits can be ordered as spare parts.

A set of shield plates is included in the scope of delivery for the motor and signal cables corresponding to the frame size for the frame sizes FSD to FSG. For the electromagnetically compatible connection of an optionally connectable braking resistor, the corresponding shield connection kit is to be ordered for frame sizes FSD to FSG.

#### Selection and ordering data

Description	Article No.
<b>Shield connection kit</b> for PM240-2 Power Modules (and SINAMICS G120C)	
• Frame size FSA	<b>6SL3266-1EA00-0KA0</b>
• Frame size FSB	<b>6SL3266-1EB00-0KA0</b>
• Frame size FSC	<b>6SL3266-1EC00-0KA0</b>
• Frame size FSD	<b>6SL3262-1AD01-0DA0</b>
• Frame size FSE	<b>6SL3262-1AE01-0DA0</b>
• Frame size FSF	<b>6SL3262-1AF01-0DA0</b>
• Frame size FSG	<b>6SL3262-1AG01-0DA0</b>

### Spare parts > Small parts assembly set for frame sizes FSD to FSG

#### Overview

A **small parts assembly set** can be ordered for SINAMICS G120 PM240-2 Power Modules, SINAMICS G120C, and SINAMICS G120X degree of protection IP20. It contains the following parts:

- Cable entries for frame sizes FSD to FSG
- 2 × 2-pole STO mating connector
- 1 set of warning labels in 30 languages

#### Selection and ordering data

Description	Article No.
<b>Small parts assembly set</b> A small parts assembly set can be ordered for SINAMICS G120 PM240-2 Power Modules, SINAMICS G120C, and SINAMICS G120X degree of protection IP20, frame sizes FSD to FSG.	<b>6SL3200-0SK08-0AA0</b>



## SINAMICS G120 standard converters

0.37 kW to 250 kW (0.5 hp to 400 hp)

### Spare parts > Terminal cover kits for frame sizes FSD to FSG

#### Overview

The terminal cover kit includes a replacement cover for the connecting terminals.

Terminal cover kits, which are suitable for the following converters in frame sizes FSD to FSG, are available:

- SINAMICS G120 PM240-2 Power Modules
- SINAMICS G120 PM250 Power Modules
- SINAMICS G120C
- SINAMICS G120X

#### Selection and ordering data

Description	Article No.
<b>Terminal cover kits for SINAMICS G120 PM240-2 Power Modules</b>	
• for frame size FSD	<b>6SL3200-0SM13-0AA0</b>
• for frame size FSE	<b>6SL3200-0SM14-0AA0</b>
• for frame size FSF	<b>6SL3200-0SM15-0AA0</b>
• for frame size FSG	<b>6SL3200-0SM16-0AA0</b>
<b>Terminal cover kits for SINAMICS G120 PM250 Power Modules</b>	
• for frame sizes FSD and FSE	<b>6SL3200-0SM11-0AA0</b>
• for frame size FSF	<b>6SL3200-0SM12-0AA0</b>
<b>Terminal cover kits for SINAMICS G120C</b>	
• for frame size FSD	<b>6SL3200-0SM13-0AA0</b>
• for frame size FSE	<b>6SL3200-0SM14-0AA0</b>
• for frame size FSF	<b>6SL3200-0SM15-0AA0</b>
<b>Terminal cover kits for SINAMICS G120X</b>	
• for frame size FSD	<b>6SL3200-0SM13-0AA0</b>
• for frame size FSE	<b>6SL3200-0SM14-0AA0</b>
• for frame size FSF	<b>6SL3200-0SM15-0AA0</b>
• for frame size FSG	<b>6SL3200-0SM16-0AA0</b>

### Spare parts > Replacement connectors

#### Overview

A set of replacement connectors for the line feeder cable, braking resistor and motor cable is available for SINAMICS G120 PM240-2 Power Modules (and SINAMICS G120C) in frame sizes FSAA (SINAMICS G120C), FSA, FSB and FSC.

#### Selection and ordering data

Description	Article No.
<b>Replacement connectors For SINAMICS G120 PM240-2 and SINAMICS G120C</b>	
• For frame sizes FSAA and FSA	<b>6SL3200-0ST05-0AA0</b>
• For frame size FSB	<b>6SL3200-0ST06-0AA0</b>
• For frame size FSC	<b>6SL3200-0ST07-0AA0</b>

## SINAMICS G120 standard converters

0.37 kW to 250 kW (0.5 hp to 400 hp)

Spare parts > Fan units

### Overview

The Power Module fans are designed for extra long service life. For special requirements, replacement fans are available that can be exchanged quickly and easily.

### Selection and ordering data

Rated power		PM240-2 Power Module standard variant		External fan unit
kW	hp	Type 6SL3210-...	Frame size	Article No.
<b>200 ... 240 V 1 AC/3 AC</b>				
0.75	1	1PB13-8 . L0	FSA	<b>6SL3200-0SF12-0AA0</b>
1.1	1.5	1PB15-5 . L0	FSB	<b>6SL3200-0SF13-0AA0</b>
1.5	2	1PB17-4 . L0		
2.2	3	1PB21-0 . L0		
3	4	1PB21-4 . L0	FSC	<b>6SL3200-0SF14-0AA0</b>
4	5	1PB21-8 . L0		
<b>200 ... 240 V 3 AC</b>				
5.5	7.5	1PC22-2 . L0	FSC	<b>6SL3200-0SF14-0AA0</b>
7.5	10	1PC22-8 . L0		
11	15	1PC24-2UL0	FSD	<b>6SL3200-0SF15-0AA0</b>
15	20	1PC25-4UL0		
18.5	25	1PC26-8UL0		
22	30	1PC28-0UL0	FSE	<b>6SL3200-0SF16-0AA0</b>
30	40	1PC31-1UL0		
37	50	1PC31-3UL0	FSF	<b>6SL3200-0SF17-0AA0</b>
45	60	1PC31-6UL0		
55	75	1PC31-8UL0		
<b>380 ... 480 V 3 AC</b>				
0.75	1	1PE12-3 . L1	FSA	<b>6SL3200-0SF12-0AA0</b>
1.1	1.5	1PE13-2 . L1		
1.5	2	1PE14-3 . L1		
2.2	3	1PE16-1 . L1		
3	4	1PE18-0 . L1		
4	5	1PE21-1 . L0	FSB	<b>6SL3200-0SF13-0AA0</b>
5.5	7.5	1PE21-4 . L0		
7.5	10	1PE21-8 . L0		
11	15	1PE22-7 . L0	FSC	<b>6SL3200-0SF14-0AA0</b>
15	20	1PE23-3 . L0		
18.5	25	1PE23-8 . L0	FSD	<b>6SL3200-0SF15-0AA0</b>
22	30	1PE24-5 . L0		
30	40	1PE26-0 . L0		
37	50	1PE27-5 . L0		
45	60	1PE28-8 . L0	FSE	<b>6SL3200-0SF16-0AA0</b>
55	75	1PE31-1 . L0		
75	100	1PE31-5 . L0	FSF	<b>6SL3200-0SF17-0AA0</b>
90	125	1PE31-8 . L0		
110	150	1PE32-1 . L0		
132	200	1PE32-5 . L0		
160	250	1PE33-0 . L0	FSG	<b>6SL3200-0SF18-0AA0</b>
200	300	1PE33-7 . L0		
250	400	1PE34-8 . L0		

## SINAMICS G120 standard converters

0.37 kW to 250 kW (0.5 hp to 400 hp)

Spare parts > Fan units

### Selection and ordering data

Rated power		PM240-2 Power Module standard variant		External fan unit
kW	hp	Type 6SL3210-...	Frame size	Article No.
<b>500 ... 690 V 3 AC</b>				
11	10	1PH21-4 . L0	FSD	<b>6SL3200-0SF15-0AA0</b>
15	15	1PH22-0 . L0		
18.5	20	1PH22-3 . L0		
22	25	1PH22-7 . L0		
30	30	1PH23-5 . L0		
37	40	1PH24-2 . L0		
45	50	1PH25-2 . L0	FSE	<b>6SL3200-0SF16-0AA0</b>
55	60	1PH26-2 . L0		
75	75	1PH28-0 . L0	FSF	<b>6SL3200-0SF17-0AA0</b>
90	100	1PH31-0 . L0		
110	100	1PH31-2 . L0		
132	125	1PH31-4 . L0		
160	150	1PH31-7CLO	FSG	<b>6SL3200-0SF18-0AA0</b>
200	200	1PH32-1CLO		
250	250	1PH32-5CLO		

## SINAMICS G120 standard converters

0.37 kW to 250 kW (0.5 hp to 400 hp)

### Spare parts > Replacement fans

#### Overview

The Power Module fans are designed for extra long service life. Replacement fans can be ordered.

#### Selection and ordering data

Rated power		PM250 Power Module		Replacement fan
kW	hp	Type 6SL3225-...	Frame size and number of fans	Article No.
<b>380 ... 480 V 3 AC</b>				
7.5	10	0BE25-5AA1	FSC, 2 fans <sup>1)</sup>	<b>6SL3200-0SF03-0AA0</b> (includes 1 replacement fan)
11	15	0BE27-5AA1		
15	20	0BE31-1AA1		
18.5	25	0BE31-5 . A0	FSD, 2 fans	<b>6SL3200-0SF04-0AA0</b> (includes 2 replacement fans)
22	30	0BE31-8 . A0		
30	40	0BE32-2 . A0		<b>6SL3200-0SF05-0AA0</b> (includes 2 replacement fans)
37	50	0BE33-0 . A0	FSE, 2 fans	<b>6SL3200-0SF04-0AA0</b> (includes 2 replacement fans)
45	60	0BE33-7 . A0		<b>6SL3200-0SF05-0AA0</b> (includes 2 replacement fans)
55	75	0BE34-5 . A0	FSF, 2 fans	<b>6SL3200-0SF06-0AA0</b> (includes 2 replacement fans)
75	100	0BE35-5 . A0		
90	125	0BE37-5 . A0		<b>6SL3200-0SF08-0AA0</b> (includes 2 replacement fans)

<sup>1)</sup> Recommendation: Even if only one fan on the Power Module is defective, it is advisable to replace both. In this case, the order quantity must be doubled.

## SINAMICS S110 servo drives 0.55 kW to 132 kW (0.75 hp to 150 hp)



<b>10/2</b>	<b>Introduction</b>
10/2	Application
10/2	More information
<b>10/3</b>	<b>SINAMICS S110 servo drives</b>
10/3	Overview
10/4	Function
10/5	Configuration
10/5	Technical specifications
10/5	More information
<b>10/6</b>	<b>CU305 Control Unit</b>
10/6	Overview
10/6	Design
10/6	Integration
10/8	Selection and ordering data
10/8	Technical specifications
<b>10/9</b>	<b>Air-cooled PM240-2 Power Modules in blocksize format</b>
10/9	Overview
10/9	Integration
10/11	Selection and ordering data
10/13	Technical specifications
10/21	Characteristic curves
<b>10/24</b>	<b>Line-side components</b>
10/24	Line filters
10/26	Line reactors
10/28	Recommended line-side overcurrent protection devices
<b>10/29</b>	<b>DC link components</b>
10/29	Braking resistors
<b>10/33</b>	<b>Load-side power components</b>
10/33	Output reactors
<b>10/37</b>	<b>Supplementary system components</b>
10/37	Shield connection kits for Power Modules
10/38	BOP20 Basic Operator Panel
10/39	Safe Brake Relay for blocksize format
<b>10/40</b>	<b>Encoder system connection</b>
10/41	SMC10 Sensor Module Cabinet-Mounted
10/42	SMC20 Sensor Module Cabinet-Mounted
10/43	SMC30 Sensor Module Cabinet-Mounted

# SINAMICS S110 servo drives

0.55 kW to 132 kW (0.75 hp to 150 hp)

## Introduction

### Application

Use	Requirements for torque accuracy/speed accuracy/position accuracy/coordination of axes/functionality					
	Continuous motion			Non-continuous motion		
	Basic	Medium	High	Basic	Medium	High
<b>Pumping, ventilating, compressing</b> 	Centrifugal pumps Radial / axial fans Compressors	Centrifugal pumps Radial / axial fans Compressors	Eccentric screw pumps	Hydraulic pumps Metering pumps	Hydraulic pumps Metering pumps	Descaling pumps Hydraulic pumps
	V20 G120C G120X	G120X G130/G150 G180 <sup>1)</sup> DCM	S120	G120	<b>S110</b>	S120
<b>Moving</b> 	Conveyor belts Roller conveyors Chain conveyors	Conveyor belts Roller conveyors Chain conveyors Lifting/lowering devices Elevators Escalators/moving walkways Indoor cranes Marine drives Cable railways	Elevators Container cranes Mining hoists Excavators for open-cast mining Test bays	Acceleration conveyors Storage and retrieval machines	Acceleration conveyors Storage and retrieval machines Cross cutters Reel changers	Storage and retrieval machines Robotics Pick & place Rotary indexing tables Cross cutters Roll feeds Engagers/disengagers
	V20 G115D G120C ET 200pro FC-2 <sup>2)</sup>	G120 G120D G130/G150 G180 <sup>1)</sup>	S120 S150 DCM	V90 G120 G120D	<b>S110</b> S210 DCM	S120 S210 DCM
<b>Processing</b> 	Mills Mixers Kneaders Crushers Agitators Centrifuges	Mills Mixers Kneaders Crushers Agitators Centrifuges Extruders Rotary furnaces	Extruders Winders/unwinders Lead/follower drives Calenders Main press drives Printing machines	Tubular bagging machines Single-axis motion control such as • Position profiles • Path profiles	Tubular bagging machines Single-axis motion control such as • Position profiles • Path profiles	Servo presses Rolling mill drives Multi-axis motion control such as • Multi-axis positioning • Cams • Interpolations
	V20 G120C	G120 G130/G150 G180 <sup>1)</sup>	S120 S150 DCM	V90 G120	<b>S110</b> S210	S120 S210 DCM
<b>Machining</b> 	Main drives for • Turning • Milling • Drilling	Main drives for • Drilling • Sawing	Main drives for • Turning • Milling • Drilling • Gear cutting • Grinding	Axis drives for • Turning • Milling • Drilling	Axis drives for • Drilling • Sawing	Axis drives for • Turning • Milling • Drilling • Lasering • Gear cutting • Grinding • Nibbling and punching
	<b>S110</b>	<b>S110</b> S120	S120	<b>S110</b>	<b>S110</b> S120	S120

Many applications in mechanical engineering and plant construction require machine axes to be positioned quickly and precisely by the simplest possible method. It is often simply a case of moving a machine axis from position X to position Y reliably and with the required level of performance. The SINAMICS S110 drive is ideally suited to this type of application. It is specially designed to position single axes accurately and effectively.

Practical application examples and descriptions are available on the internet at [www.siemens.com/sinamics-applications](http://www.siemens.com/sinamics-applications)

### More information

You may also be interested in these frequency converters:

- Single-axis AC/AC servo converter system with high performance and dynamic response for mid-range Motion Control applications ⇒ SINAMICS S210 ([Catalog D 32](#))
- Higher performance, more functionality ⇒ SINAMICS S120 ([Catalog D 21.4](#))
- I/O extension using additional modules ⇒ SINAMICS S120 ([Catalog D 21.4](#))
- Operation of linear and torque motors ⇒ SINAMICS S120 ([Catalog D 21.4](#))
- Reduced functionality for basic applications with standard asynchronous (induction) motors ⇒ SINAMICS G120

<sup>1)</sup> Industry-specific converters.

<sup>2)</sup> Information on the SIMATIC ET 200pro FC-2 frequency converter is available in Catalog D 31.2 and at [www.siemens.com/et200pro-fc](http://www.siemens.com/et200pro-fc)

## Overview

### **SINAMICS S110 – the basic positioning drive for single-axis applications**



SINAMICS S110: PM240-2 Power Modules in blocksize format with CU305 Control Unit and BOP20

SINAMICS S110 can be used in numerous applications. Typical examples are:

- Handling equipment
- Feed and withdrawal devices
- Stacking units
- Automatic assembly machines
- Laboratory automation
- Metalworking
- Woodworking, glass and ceramic industries
- Printing machines
- Plastics processing machines

The SINAMICS S110 servo drive is designed for connection to both synchronous servomotors and asynchronous (induction) motors. It supports all the most popular types of encoder.

A variety of fieldbus interfaces is provided for linking the unit to a higher-level control system. Alternatively, it can be controlled via  $\pm 10$  V and a pulse direction interface.

The so-called basic positioner (EPos) is an integral component of SINAMICS S110. It provides a simple method of solving positioning tasks.

#### **Flexible in application**

SINAMICS S110 is a flexible, versatile system.

Synchronous servomotors and asynchronous (induction) motors with outputs up to 132 kW can be used to implement rotary or linear axes. DRIVE-CLiQ motors can be connected simply by means of the integrated DRIVE-CLiQ interface. This means that the electronic rating plate of the motor is easy to read out, reducing the engineering time and cost involved in commissioning the drive.

Furthermore, the SINAMICS S110 features an integrated encoder interface for optional use. It is capable of evaluating HTL/TTL and SSI encoders.

In addition to pure point-to-point positioning, SINAMICS S110 naturally also offers on-the-fly changeover from continuous operation to positioning mode in order, for example, to precisely position objects transported randomly on a conveyor belt. Even simple traversing profiles with different motion cycles and wait times can be executed automatically by SINAMICS S110.

The CU305 Control Unit of the SINAMICS S110 is equipped with an integrated communication interface for linking the converter to an automation system. A PROFINET or PROFIBUS interface can be ordered. Standardized protocols for linking to a higher-level control are supported – the PROFIdrive profile for positioning mode and the PROFIsafe profile for safety-related communication.

The converter is thus perfectly coordinated with the SIMATIC S7 automation system. The devices are linked by means of PROFIBUS and the SIMATIC S7 uses standard function blocks to communicate with the drive. In addition, the STARTER commissioning tool can be seamlessly integrated into STEP 7, the SIMATIC's programming software.

#### **BICO technology**

Every drive object contains a large number of input and output variables which can be freely and independently interconnected using Binector Connector Technology (BICO). A binector is a logic signal which can assume the value 0 or 1. A connector is a numerical value, e.g. the actual speed or current setpoint.

#### **Basic positioner (EPos)**

The EPos basic positioner provides powerful and precise positioning functions. Due to its flexibility and adaptability, the EPos basic positioner can be used for a wide range of positioning tasks. The functions are easy to use during both commissioning and operation, and the comprehensive monitoring functions are very powerful. Many applications can be implemented without external position control systems.

[Additional information about the basic positioner \(EPos\) is provided in the section Technology functions.](#)

#### **Free function blocks**

The drive can be adapted easily and precisely to a wide range of customized requirements using the "free function blocks" integrated in the CU305 Control Unit. The available range of blocks includes simple logic blocks such as AND/OR elements, as well as more complex devices such as smoothing elements or limit-value monitors. All blocks can be flexibly interconnected using BICO (Binector-Connector) technology, ensuring that signals are processed quickly and close to the drive which helps reduce the load on the higher-level control.

[Additional information about Free Function Blocks \(FBB\) is provided in the section Technology functions.](#)

#### **Diagnostics optimally supported by trace function**

The time characteristics of input and output variables associated with drives can be measured by the integrated trace function and displayed using the STARTER commissioning tool. The trace can record up to 4 signals simultaneously. Recording can be triggered as a function of freely selectable boundary conditions, e.g. the value of an input or output variable.

## SINAMICS S110 servo drives

0.55 kW to 132 kW (0.75 hp to 150 hp)

### SINAMICS S110 servo drives

#### Overview

##### Integral safety functions (Safety Integrated)

The Control Unit supports comprehensive safety functions. The integrated safety functions are the

##### Safety Integrated Basic functions

- STO = Safe Torque Off
- SBC = Safe Brake Control
- SS1 = Safe Stop 1

and the

##### Safety Integrated Extended functions under license

- SS2 = Safe Stop 2
- SOS = Safe Operating Stop
- SLS = Safely-Limited Speed
- SSM = Safe Speed Monitor
- SDI = Safe Direction

(abbreviations in accordance with IEC 61800-5-2)

If the integrated safety functions are used, licenses, supplementary system components such as Safe Brake Relay, or suitable safety controls will be necessary.

Additional information about the integrated safety functions is provided in the section [Safety Integrated](#).

##### Memory cards

The memory card can be used as an option for SINAMICS S110. The relevant slot is located underneath the CU305 Control Unit. The complete functionality of SINAMICS S110 can be saved on the memory card: the parameter settings and the firmware. When service is required, e.g. after the converter has been replaced and the data has been downloaded from the memory card, the drive system is immediately ready for use once more.

A SINAMICS Micro Memory Card (MMC) is essential if the optional Safety Integrated Extended functions are used. The necessary license is saved on the MMC.

##### Varnished modules

The following units are equipped as standard with varnished or partially varnished modules:

- Blocksize format units
- Control Units
- Sensor Modules

The varnish coating protects the sensitive SMD components against corrosive gases, chemically active dust and moisture.

##### Extended warranty

For SINAMICS S110, Siemens offers an optional extension of warranty up to 5½ years via **Service Protect**:

- Free for the first 6 months after registering the product at: <https://myregistration.siemens.com>
- Subject to a charge for a further 3 or 5 years

You can find detailed information here:

<https://support.industry.siemens.com/cs/ww/en/sc/4842>

Concerning standard warranty please ask your partner at Siemens. Your partner can be found in our Personal Contacts Database at:

[www.siemens.com/automation-contact](http://www.siemens.com/automation-contact)

#### Function

SINAMICS S110 – Summary of the most important functions	
<b>Control method</b>	Servo control
• Asynchronous (induction) motor	Torque control with encoder Speed control with and without encoder Position control with encoder
• Synchronous motor	Torque control with encoder Speed control with encoder Position control with encoder
<b>Control function</b>	V/f characteristic
• Asynchronous (induction) motor	Basic linear
• Synchronous motor	–
<b>Basic positioner (EPos)</b>	Absolute and relative positioning Linear and rotary axes Motor encoder or direct measuring system 4 referencing modes 16 traversing blocks Direct setpoint specification (MDI) Jog mode Backlash compensation Following error monitoring Cam signals Position tracking for extended position range ....
<b>Safety Integrated</b>	Safe Torque OFF (STO) Safe Brake Control (SBC) Safe Stop 1 (SS1) Safe Stop 2 (SS2) Safe Operating Stop (SOS) Safely-Limited Speed (SLS) Safe Speed Monitor (SSM) Safe Direction (SDI)
<b>Protection functions</b>	Undervoltage DC link voltage Overvoltage DC link voltage Overcurrent power unit Overcurrent motor Overload power unit ( $I^2t$ ) Short circuit Ground fault Overtemperature motor Overtemperature power unit
<b>Functions for simplified commissioning</b>	Electronic rating plate for motors with DRIVE-CLiQ Motor data identification Pole position identification Automatic controller optimization with STARTER
<b>Free function blocks</b>	Logic and arithmetic blocks
<b>Data sets</b>	2 command data sets 2 drive data sets 2 motor data sets 1 encoder data set
<b>Further software functions</b>	BICO interconnection Technology controller (PID) Extended setpoint channel Automatic restart Armature short-circuit brake DC brake Brake control $V_{dc\_min}$ control (kinetic buffering) $V_{dc\_max}$ control Travel to fixed stop Vertical axis Variable signaling functions Central measuring probe evaluation Pulse direction interface Efficiency optimization for asynchronous (induction) motors Runtime (operating hours counter)



## Configuration

The following electronic configuring aids and engineering tools are available for the SINAMICS S110 servo drives:

### **SINAMICS DriveSim Basic (firmware V4.4 SP3 or higher)**

SINAMICS DriveSim Basic provides easy-to-use models for PROFIdrive-enabled SINAMICS converters, so you can create a digital twin of your drive.

More information is provided on the internet at:  
<https://support.industry.siemens.com/cs/document/109798225>

### **Siemens Product Configurator**

The Siemens Product Configurator can be used on the internet without requiring any installation. The Siemens Product Configurator can be found in the Siemens Industry Mall at the following address:

[www.siemens.com/spc](http://www.siemens.com/spc)

### **SIZER for Siemens Drives engineering tool (integrated into TIA Selection Tool)**

The SIZER for Siemens Drives engineering tool makes it easy to configure the SINAMICS drive family. It provides support when selecting the hardware and firmware components necessary to implement a drive task. SIZER for Siemens Drives is designed to support configuring of the entire drive system.

You can find further information on the SIZER for Siemens Drives engineering tool in the section [Engineering tools](#).

The SIZER for Siemens Drives engineering tool is available free on the internet at

[www.siemens.com/sizer](http://www.siemens.com/sizer)

### **STARTER commissioning tool**

The STARTER commissioning tool allows menu-prompted commissioning, optimization and diagnostics as well as the TIA functionality. Apart from the SINAMICS drives, STARTER is also suitable for MICROMASTER 4 devices.

You can find further information about the STARTER commissioning tool in the section [Engineering tools](#).

Additional information about the STARTER commissioning tool is available on the internet at

[www.siemens.com/starter](http://www.siemens.com/starter)

### **Drive ES engineering system**

Drive ES is the engineering system that can be used to integrate the communication, configuration and data management functions of Siemens drive technology into the SIMATIC automation world easily, efficiently and cost-effectively. The Drive ES PCS software package is available for SINAMICS.

You can find further information about the Drive ES engineering system in the section [Engineering tools](#).

Additional information about the Drive ES engineering system is available on the internet at

[www.siemens.com/drive-es](http://www.siemens.com/drive-es)

## Technical specifications

The most important directives and standards are listed below. These are used as basis for the SINAMICS S110 servo drives and must be carefully observed to achieve an EMC-compliant configuration that is safe both functionally and in operation.

### European standards

EN 61508-1	Functional safety of electrical/electronic/programmable electronic safety-related systems Part 1: General requirements
EN 60204-1	Electrical equipment of machines Part 1: General definitions
EN 61800-3	Adjustable speed electrical power drive systems Part 3: EMC product standard including specific test methods
IEC/EN 61800-5-1	Adjustable speed electrical power drive systems Part 5: Safety requirements Main section 1: Electrical and thermal requirements

### North American standards

UL 508C	Power Conversion Equipment
UL 61800-5-1	Adjustable Speed Electrical Power Drive Systems
CSA C22.2 No. 14	Industrial Control Equipment

### Certificates of suitability

cULus	Testing by UL (Underwriters Laboratories, <a href="http://www.ul.com">www.ul.com</a> ) according to UL and CSA standards
-------	--

## More information

For reliable operation of the drive system, original components of the SINAMICS drive system and the original Siemens accessories as described in this Catalog and the Configuration Manuals, in the functional descriptions or user manuals must be used.

The user must observe the configuring instructions.

Combinations that differ from the configuring instructions (also in conjunction with non-Siemens products) require a special agreement.

If no original components are used, for example, for repairs, approvals such as UL, EN and Safety Integrated can become invalid. This may also result in the operating authorization for the machine in which the non-Siemens components are installed becoming invalid.

All of the certificates of suitability, approvals, certificates, declarations of conformity, test certificates, e.g. CE, UL, Safety Integrated, have been performed with the associated system components as they are described in the Catalogs and Configuration Manuals. The certificates are only valid if the products are used with the described system components, are installed according to the Installation Guidelines and are used for their intended purpose. In other cases, the vendor of these products is responsible for arranging that new certificates are issued.

## SINAMICS S110 servo drives

0.55 kW to 132 kW (0.75 hp to 150 hp)

### CU305 Control Unit

#### Overview



CU305 PN Control Unit

The CU305 Control Unit for the communication and open-loop/closed-loop control functions of a SINAMICS S110 is combined with the PM240-2 Power Module in blocksize format (usable as of firmware V4.4 SP3) to create a powerful single drive.

#### Design

The CU305 Control Unit features the following connections and interfaces as standard:

- Fieldbus interface
  - CU305 PN: 1 PROFINET interface with 2 ports (RJ45 sockets) with PROFIdrive V4 profile
  - CU305 DP: 1 PROFIBUS interface with PROFIdrive V4 profile
- 1 DRIVE-CLiQ socket, used solely to connect a DRIVE-CLiQ motor or a Sensor Module
- 1 onboard encoder evaluation for evaluating the following encoder signals
  - Incremental encoder TTL/HTL
  - SSI encoder without incremental signals
- 1 PE/protective conductor connection
- 1 connection for the electronics power supply via the 24 V DC power supply connector
- 1 temperature sensor input (KTY84-130 or PTC)
- 3 parameterizable, fail-safe digital inputs (isolated), or alternatively 6 parameterizable digital inputs (isolated)
- 5 parameterizable digital inputs (isolated)
- 1 parameterizable, fail-safe digital output (isolated), or alternatively 1 digital output (isolated)
- 4 parameterizable bidirectional digital inputs/outputs
- 1 analog input  $\pm 10$  V, resolution 12 bit + sign
- 1 serial RS232 interface
- 1 slot for the memory card on which the firmware, parameters and licenses can be stored
- 1 PM-IF interface for communication with the PM240-2 Power Modules in blocksize format (usable as of firmware V4.4 SP3)
- 2 test sockets and one reference ground for commissioning support
- 1 interface to the BOP20 Basic Operator Panel

#### Integration

The CU305 Control Unit controls the PM240-2 Power Module in blocksize format (usable as of firmware V4.4 SP3) via the PM-IF interface.

A BOP20 Basic Operator Panel can also be snapped directly onto the CU305 for diagnostic purposes.

DRIVE-CLiQ motors can be connected to the integrated DRIVE-CLiQ socket as well as Sensor Modules (SMC) to permit the operation of motors without a DRIVE-CLiQ interface.

The status of the CU305 is indicated via multi-color LEDs.

The CU305 can be operated optionally with memory card. The firmware and project data are stored on the memory card pluggable from below, so that the CU305 can be replaced without the support of software tools. This memory card can also be used to perform standard commissioning on multiple drives of identical type. The memory card is available containing the latest drive firmware version. The card also contains the safety license for the Extended Safety Functions. To use these Extended Safety Functions, a memory card containing the safety license must be permanently inserted.

The CU305 and other connected components are commissioned and diagnosed with the STARTER commissioning tool.

**Integration**

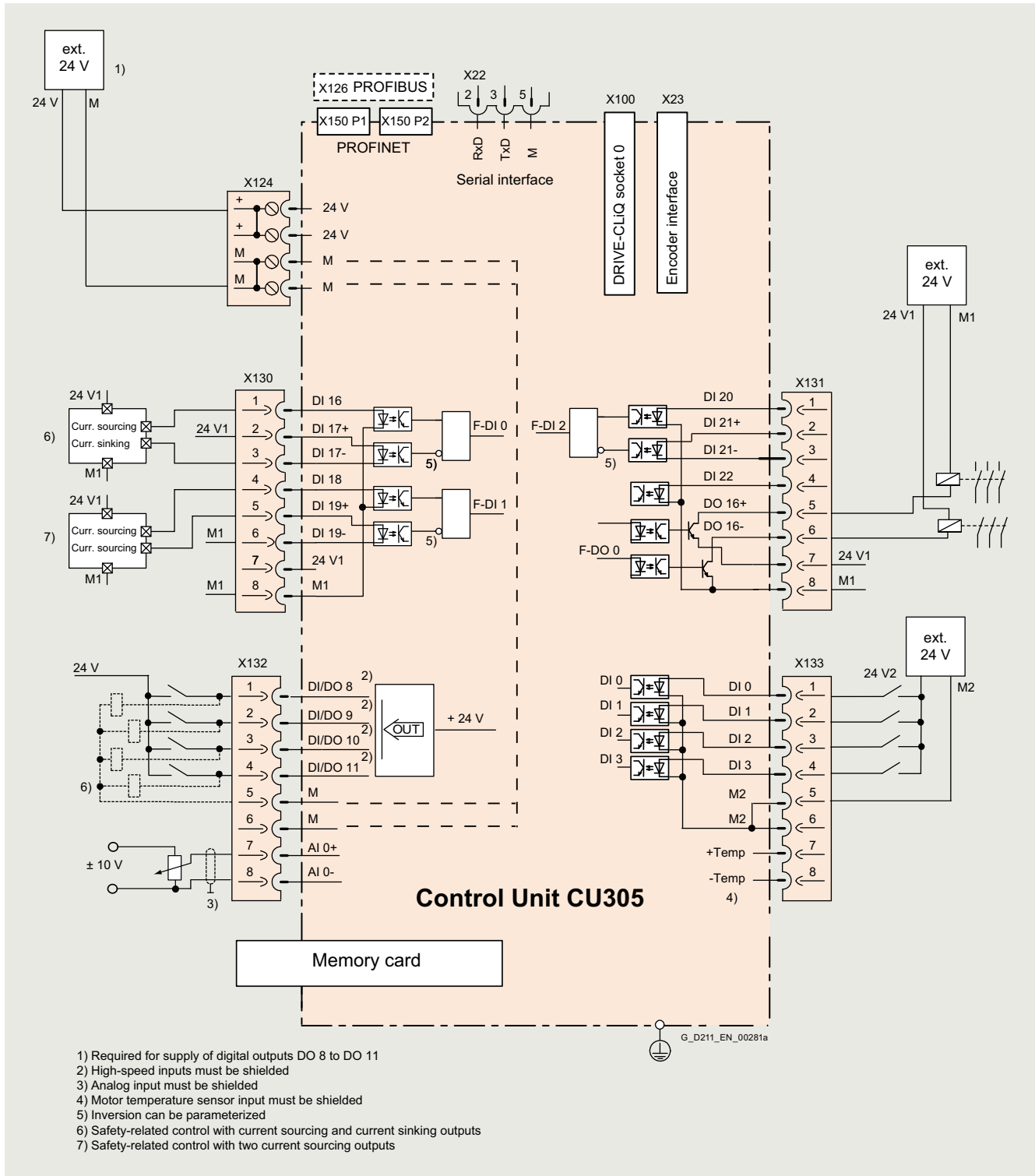

Connection example of CU305 Control Unit

**SINAMICS S110 servo drives**

0.55 kW to 132 kW (0.75 hp to 150 hp)

**CU305 Control Unit****Selection and ordering data**

Description	Article No.
<b>CU305 PN Control Unit</b> Without memory card	<b>6SL3040-0JA01-0AA0</b>
<b>CU305 DP Control Unit</b> Without memory card	<b>6SL3040-0JA00-0AA0</b>

Description	Article No.
<b>Accessories</b>	
<b>Memory card for CU305 PN / CU305 DP Control Units</b> 64 MB	
• With firmware version V4.4 SP3	<b>6SL3054-4TC00-2AA0</b>
• With firmware version V4.4 SP3 and safety license (Extended Functions)	<b>6SL3054-4TC00-2AA0-Z F01</b>
<b>Safety license (Extended Functions) <sup>1)</sup></b> CoL in electronic form	<b>6SL3074-0AA10-0AH0</b>
<b>STARTER commissioning tool <sup>2)</sup></b> on DVD-ROM	<b>6SL3072-0AA00-0AG0</b>

**Technical specifications**

<b>CU305 PN / CU305 DP Control Units</b> PROFINET: 6SL3040-0JA01-0AA0 PROFIBUS: 6SL3040-0JA00-0AA0	
<b>Current requirement</b> At 24 V DC, max. without taking account of digital outputs and DRIVE-CLiQ supply	0.8 A for CU305 incl. 350 mA for HTL encoder + 0.5 A for PM240-2 Power Module
<b>Conductor cross-section, max.</b>	2.5 mm <sup>2</sup>
<b>Fuse protection, max.</b>	20 A
<b>Digital inputs</b>	in accordance with IEC 61131-2 Type 1 3 isolated fail-safe inputs 5 isolated digital inputs
• Voltage	-3 ... +30 V
• Low level (an open digital input is interpreted as "low")	-3 ... +5 V
• High level	15 ... 30 V
• Current consumption at 24 V DC, typ.	6 mA
• Delay time of digital inputs <sup>3)</sup> , approx.	
- L → H	15 μs
- H → L	55 μs
• Delay time of high-speed digital inputs <sup>3)</sup> , approx. (high-speed digital inputs can be used for position detection)	
- L → H	5 μs
- H → L	5 μs
• Conductor cross-section, max.	1.5 mm <sup>2</sup>
<b>Digital outputs</b> (continuously short-circuit-proof)	1 fail-safe digital output 4 bidirectional digital inputs/digital outputs, not isolated
• Voltage	24 V DC
• Load current per digital output <sup>4)</sup> , max.	100 mA
• Delay time <sup>3)</sup> , approx.	150 μs
• Conductor cross-section, max.	1.5 mm <sup>2</sup>
<b>Analog input</b>	-10 ... +10 V Resolution 12 bits + sign
• Internal resistance	15 kΩ

<b>CU305 PN / CU305 DP Control Units</b> PROFINET: 6SL3040-0JA01-0AA0 PROFIBUS: 6SL3040-0JA00-0AA0	
<b>Encoder evaluation</b>	• Incremental encoder TTL/HTL • SSI encoder without incremental signals
• Encoder supply	24 V DC/0.35 A or 5 V DC/0.35 A
• Input current range TTL/HTL	2 ... 10 mA (typ. 5 mA)
• Encoder frequency, max.	500 kHz
• SSI baud rate	100 ... 250 kBaud depending on cable length
• Resolution absolute position SSI	30 bit
• Cable length, max.	
- TTL encoder	100 m (328 ft) (only bipolar signals permitted <sup>5)</sup> )
- HTL encoder	100 m (328 ft) for unipolar signals 300 m (984 ft) for bipolar signals <sup>5)</sup>
- SSI encoder	100 m (328 ft)
<b>Power loss</b>	<20 W
<b>PE connection</b>	M5 screw
<b>Dimensions</b>	
• Width	73 mm (2.87 in)
• Height	
- CU305 PN	195 mm (7.68 in)
- CU305 DP	183.2 mm (7.21 in)
• Depth	
- CU305 PN	71 mm (2.80 in)
- CU305 DP	55 mm (2.17 in)
<b>Weight, approx.</b>	0.95 kg (2.09 lb)
<b>Certificate of suitability</b>	cULus

<sup>1)</sup> Extended function for an existing memory card. The memory card is not included with the scope of delivery. With a CoL in electronic form, the license is supplied as a PDF file. Notification of this with a download link is received by email. By specifying the Z option **F01** it is possible to order the safety license together with a memory card. In this case, the Certificate of License (CoL) is located on the SINAMICS SD card. In addition, there is a notification with an optional download by email.

<sup>2)</sup> The STARTER commissioning tool is also available on the internet at <https://support.industry.siemens.com/cs/ww/en/ps/13437/dl>

<sup>3)</sup> The specified delay times refer to the hardware. The actual reaction time depends on the time slice in which the digital input or output is processed.

<sup>4)</sup> In order to use the digital outputs, an external 24 V power supply must be connected to terminal X124.

<sup>5)</sup> Signal cables twisted in pairs and shielded.

# SINAMICS S110 servo drives

0.55 kW to 132 kW (0.75 hp to 150 hp)

## Air-cooled PM240-2 Power Modules in blocksize format

### Overview

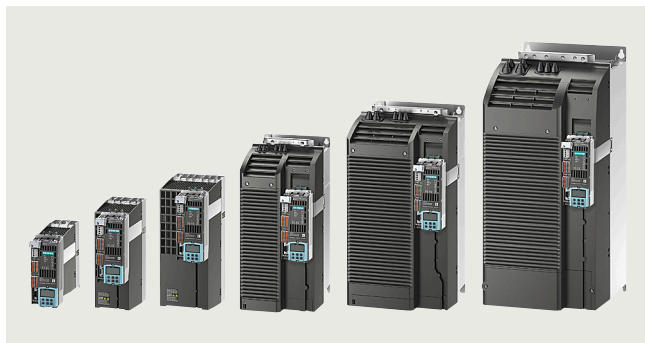

PM240-2 Power Modules, frame sizes FSA to FSF (with Control Unit and BOP-20 Operator Panel)

The PM240-2 Power Modules in blocksize format feature the following connections and interfaces as standard:

- Line supply connection
- PM-IF interface to connect the PM240-2 Power Module to the CU305 Control Unit. The PM240-2 Power Module also supplies power to the CU305 Control Unit using an integrated power supply
- Terminals DCP/R1 and R2 for connection of an external braking resistor
- Motor connection made with screw terminals or screw studs
- Control circuit for the Safe Brake Relay for controlling a holding brake
- 2 PE/protective conductor connections

Power Modules without integrated line filter can be connected to grounded TN/TT systems and non-grounded IT systems. Power Modules with integrated line filter are suitable only for connection to TN systems with grounded neutral point.

#### Note:

Shield connection kits are available for EMC-compliant installation of Power Modules.

A shield connection kit is supplied as standard with PM240-2 Power Modules in frame sizes FSA to FSC.

A set of shield plates is included in the scope of delivery for the motor and signal cables corresponding to the frame size for the frame sizes FSD to FSF. For the electromagnetically compatible connection of an optionally connectable braking resistor, the corresponding shield connection kit is to be ordered for frame sizes FSD to FSF.

For more information, see shield connection kits for Power Modules in the section Supplementary system components.

#### Additional options

Further selected accessories are available from "Siemens Product Partner for Drives Options":

[www.siemens.com/drives-options-partner](http://www.siemens.com/drives-options-partner)

### Integration

PM240-2 Power Modules in blocksize format communicate via the PM-IF interface with the CU305 Control Unit

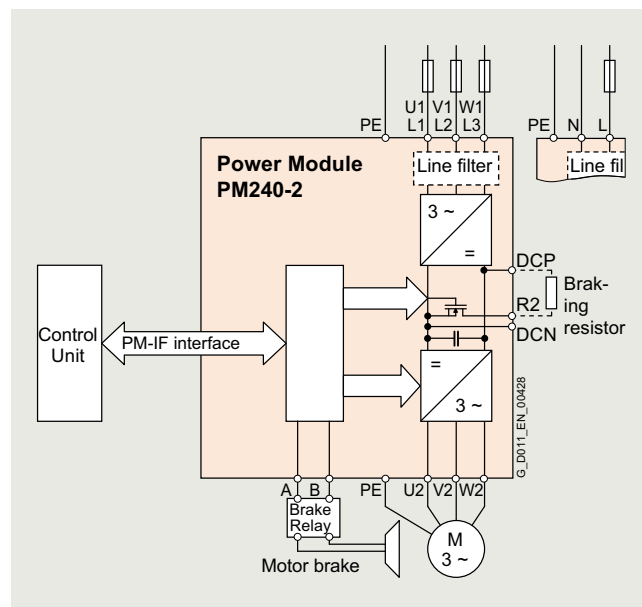

Connection example for PM240-2 Power Modules, frame sizes FSA to FSC, with or without integrated line filter

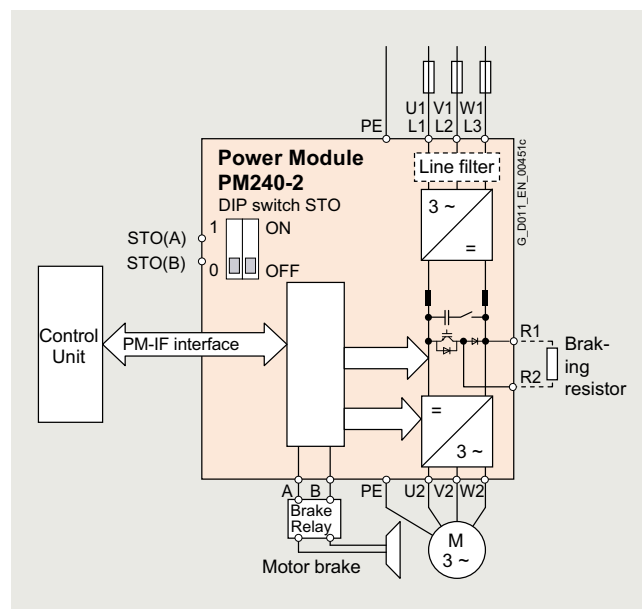

Connection example for PM240-2 Power Modules, frame sizes FSD to FSF, with or without integrated line filter

## SINAMICS S110 servo drives

0.55 kW to 132 kW (0.75 hp to 150 hp)

### Air-cooled PM240-2 Power Modules in blocksize format

#### Integration

##### Power and DC link components that are optionally available depending on the Power Module used

The following line-side components, DC link components and load-side power components are optionally available in the appropriate frames sizes for the Power Modules:

	Frame size					
	FSA	FSB	FSC	FSD	FSE	FSF
<b>PM240-2 Power Module with integrated braking chopper</b>						
<b>Line-side components</b>						
Line filter class A acc. to EN 55011	F	F	F	F <sup>1)</sup>	F <sup>1)</sup>	F <sup>1)</sup>
Line filter class B acc. to EN 55011 (only for 400 V versions)	U	U	U	–	–	–
Line reactor (only for 3 AC versions <sup>2)</sup> )	S <sup>3)</sup>	S <sup>3)</sup>	S <sup>3)</sup>	I	I	I
<b>DC link components</b>						
Braking resistor	S	S	S	S	S	S
<b>Load-side power components</b>						
Output reactor	S	S	S	S	S	S

F = Power Modules available with and without integrated filter class A

U = Base component

S = Lateral mounting

I = Integrated

– = Not possible

#### General design information

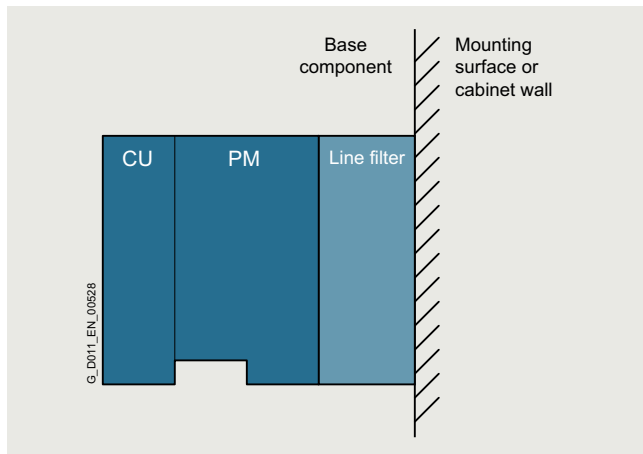

- If at all possible, the line filter should be mounted directly below the converter
- With lateral mounting, the line-side components have to be mounted on the left side of the converter, and the load-side components on the right side
- Braking resistors have to be mounted directly on the control cabinet wall due to heating issues

Frequency converter comprising a Power Module (PM), a Control Unit (CU), and a line filter as base components (side view)

#### Recommended installation combinations of the converter and optional power and DC link components

Power Module Frame size	Base	Lateral mounting	
		Left of the converter (for line-side components)	Right of the converter (for load-side power components and DC link components)
FSA to FSC	Line filter	Line reactor	Output reactor and/or braking resistor
FSD to FSF	–	Line filter	Output reactor and/or braking resistor

<sup>1)</sup> PM240-2 200 V versions, frame sizes FSD to FSF are only available without integrated line filter.

<sup>2)</sup> With the appropriate wiring, the line reactors for 200 V 3 AC can be used for the 200 V versions for 200 V 1 AC. More information can be found on the internet at:  
<https://support.industry.siemens.com/cs/document/109482011>

<sup>3)</sup> For frame sizes FSA to FSC, for lines with uk < 1 %, it is recommended that you use a line reactor or the next more powerful Power Module. More information can be found on the internet at:  
<https://support.industry.siemens.com/cs/document/109482011>

## SINAMICS S110 servo drives

0.55 kW to 132 kW (0.75 hp to 150 hp)

### Air-cooled PM240-2 Power Modules in blocksize format

#### Selection and ordering data

To ensure that a suitable Power Module is selected, the following currents should be used for applications:

- Rated output current for applications with low overload (LO)
- Base-load current for applications with high overload (HO)

With reference to the rated output current, the modules support at least 2-pole to 6-pole low-voltage motors, e.g. the

SIMOTICS 1LE1 motor series. The type rating is merely a guide value. For a description of the overload performance, please refer to the general technical specifications of the Power Modules.

#### PM240-2 Power Modules standard variant

Type rating <sup>1)</sup>		Rated output current $I_N$ <sup>2)</sup>		Power based on the base-load current <sup>3)</sup>		Base-load current $I_H$ <sup>3)</sup>	Frame size	PM240-2 Power Module standard variant without integrated line filter	PM240-2 Power Module standard variant with integrated line filter class A
kW	hp	A	kW	hp	A			Article No.	Article No.
<b>200 ... 240 V 1 AC/3 AC</b>									
0.55	0.75	3.2	0.37	0.5	2.3	FSA	6SL3210-1PB13-0UL0	6SL3210-1PB13-0AL0	
0.75	1	4.2	0.55	0.75	3.2	FSA	6SL3210-1PB13-8UL0	6SL3210-1PB13-8AL0	
1.1	1.5	6	0.75	1	4.2	FSB	6SL3210-1PB15-5UL0	6SL3210-1PB15-5AL0	
1.5	2	7.4	1.1	1.5	6	FSB	6SL3210-1PB17-4UL0	6SL3210-1PB17-4AL0	
2.2	3	10.4	1.5	2	7.4	FSB	6SL3210-1PB21-0UL0	6SL3210-1PB21-0AL0	
3	4	13.6	2.2	3	10.4	FSC	6SL3210-1PB21-4UL0	6SL3210-1PB21-4AL0	
4	5	17.5	3	4	13.6	FSC	6SL3210-1PB21-8UL0	6SL3210-1PB21-8AL0	
<b>380 ... 480 V 3 AC <sup>4)</sup></b>									
0.55	0.75	1.7	0.37	0.5	1.3	FSA	6SL3210-1PE11-8UL1	6SL3210-1PE11-8AL1	
0.75	1	2.2	0.55	0.75	1.7	FSA	6SL3210-1PE12-3UL1	6SL3210-1PE12-3AL1	
1.1	1.5	3.1	0.75	1	2.2	FSA	6SL3210-1PE13-2UL1	6SL3210-1PE13-2AL1	
1.5	2	4.1	1.1	1.5	3.1	FSA	6SL3210-1PE14-3UL1	6SL3210-1PE14-3AL1	
2.2	3	5.9	1.5	2	4.1	FSA	6SL3210-1PE16-1UL1	6SL3210-1PE16-1AL1	
3	4	7.7	2.2	3	5.9	FSA	6SL3210-1PE18-0UL1	6SL3210-1PE18-0AL1	
4	5	10.2	3	4	7.7	FSB	6SL3210-1PE21-1UL0	6SL3210-1PE21-1AL0	
5.5	7.5	13.2	4	5	10.2	FSB	6SL3210-1PE21-4UL0	6SL3210-1PE21-4AL0	
7.5	10	18	5.5	7.5	13.2	FSB	6SL3210-1PE21-8UL0	6SL3210-1PE21-8AL0	
11	15	26	7.5	10	18	FSC	6SL3210-1PE22-7UL0	6SL3210-1PE22-7AL0	
15	20	32	11	15	26	FSC	6SL3210-1PE23-3UL0	6SL3210-1PE23-3AL0	
18.5	25	38	15	20	32	FSD	6SL3210-1PE23-8UL0	6SL3210-1PE23-8AL0	
22	30	45	18.5	25	38	FSD	6SL3210-1PE24-5UL0	6SL3210-1PE24-5AL0	
30	40	60	22	30	45	FSD	6SL3210-1PE26-0UL0	6SL3210-1PE26-0AL0	
37	50	75	30	40	60	FSD	6SL3210-1PE27-5UL0	6SL3210-1PE27-5AL0	
45	60	90	37	50	75	FSE	6SL3210-1PE28-8UL0	6SL3210-1PE28-8AL0	
55	75	110	45	60	90	FSE	6SL3210-1PE31-1UL0	6SL3210-1PE31-1AL0	
75	100	145	55	75	110	FSF	6SL3210-1PE31-5UL0	6SL3210-1PE31-5AL0	
90	125	178	75	100	145	FSF	6SL3210-1PE31-8UL0	6SL3210-1PE31-8AL0	
110	150	205	90	125	178	FSF	6SL3210-1PE32-1UL0	6SL3210-1PE32-1AL0	
132	200	250	110	150	205	FSF	6SL3210-1PE32-5UL0	6SL3210-1PE32-5AL0	

<sup>1)</sup> Type rating based on the rated output current  $I_N$ . The rated output current  $I_N$  is based on the duty cycle for low overload (LO).

<sup>2)</sup> The rated output current  $I_N$  is based on the duty cycle for low overload (LO). These current values are valid for 200 V or 400 V and are specified on the rating plate of the Power Module.

<sup>3)</sup> The base-load current  $I_H$  is based on the duty cycle for high overload (HO).

<sup>4)</sup> SIPLUS components for extreme requirements are available. Additional information is available on the internet at [www.siemens.com/siplus-drives](http://www.siemens.com/siplus-drives)

## SINAMICS S110 servo drives

0.55 kW to 132 kW (0.75 hp to 150 hp)

### Air-cooled PM240-2 Power Modules in blocksize format

#### Selection and ordering data

##### **Shield connection kit for Power Modules**

The shield connection kit makes it easier to connect the shields of supply and control cables, provides mechanical strain relief and thus ensures optimum EMC performance.

A shield connection kit is supplied as standard with PM240-2 Power Modules in frame sizes FSA to FSC.

A set of shield plates is included in the scope of delivery for the motor and signal cables corresponding to the frame size for the frame sizes FSD to FSF. For the electromagnetically compatible connection of an optionally connectable braking resistor, the corresponding shield connection kit is to be ordered for frame sizes FSD to FSF.

For more information, see [shield connection kits for Power Modules](#) in the section [Supplementary system components](#).



# SINAMICS S110 servo drives

0.55 kW to 132 kW (0.75 hp to 150 hp)

## Air-cooled PM240-2 Power Modules in blocksize format

### Technical specifications

#### General technical specifications

Unless explicitly specified otherwise, the following technical specifications are valid for all PM240-2 Power Modules in blocksize format, frame sizes FSA to FSF.

#### Note:

When configuring the complete SINAMICS S110 drive, the system data of the associated Control Units, supplementary system components, DC link components and Sensor Modules must be taken into consideration.

Electrical specifications	
<b>Line voltage</b>	
• Blocksize format FSA ... FSC	200 ... 240 V 1 AC ±10 % 200 ... 240 V 3 AC ±10 % 380 ... 480 V 3 AC ±10 %
• Blocksize format FSD ... FSF	380 ... 480 V 3 AC ±10 % (in operation -20 % <1 min)
<b>Line system configurations</b>	Grounded TN/TT systems and non-grounded IT systems (IT networks can only be used for unfiltered devices)
<b>Line frequency</b>	47 ... 63 Hz
<b>Line power factor</b> for a 3 AC line supply voltage and type rating	
• Blocksize format FSA ... FSC	
- Fundamental power factor (cos φ <sub>1</sub> )	>0.96
- Total (λ)	> 0.7 ... 0.85
• Blocksize format FSD ... FSF	
- Fundamental power factor (cos φ <sub>1</sub> )	> 0.98 ... 0.99
- Total (λ)	> 0.9 ... 0.92
<b>Efficiency class acc. to IEC 61800-9-2</b>	IE2
<b>Electromagnetic compatibility<sup>1)</sup></b>	
• Interference immunity	All PM240-2 Power Modules are suitable for use in both the first and second environments.
• Interference emission acc. to EN 61800-3 <b>second environment</b>	
- For devices with integrated radio suppression interference filter	Category C2
- For devices without integrated radio interference suppression filter with optional external radio interference filter for grounded line supplies	Category C2 (recommended for operation in conjunction with a residual current protective device RCD)
- For devices without integrated radio interference suppression filter for operation on IT line supplies	Category C4
• Interference emission acc. to EN 61800-3 <b>first environment</b>	Can be used in the first environment when taking into consideration the additional secondary conditions listed in the EMC notes
<b>Overvoltage category</b> acc. to IEC/EN 61800-5-1	III
<b>Electronics power supply</b> implemented as PELV circuit according to IEC/EN 61800-5-1	24 V DC, -15 % +20 % Ground = negative pole grounded via the electronics
<b>Short-circuit current rating (SCCR)</b> (Short Circuit Current Rating) Applies to industrial control cabinet installations according to NEC Article 409 or UL 508A.	100 kA <a href="#">See the Recommended line-side overcurrent protection devices section</a> – the value depends on the fuses and circuit breakers used
<b>Rated pulse frequency</b>	
• For devices with a rated voltage of 200 V 1/3 AC, 400 V 3 AC and a type rating ≤ 55 kW based on I <sub>N</sub>	4 kHz
• For devices with a type rating ≥ 75 kW based on I <sub>N</sub>	2 kHz
<b>Output voltage, max.</b>	Approximately 0.95 × line voltage (at 200 V 1 AC, approximately 0.74 × line voltage)
<b>Output frequency</b>	0 ... 550 Hz (dependencies on the control mode and pulse frequency must be taken into account)

<sup>1)</sup> For EMC-compliant installation, observe the information in the Configuration Manual EMC installation guidelines:  
<https://support.industry.siemens.com/cs/document/60612658>

**SINAMICS S110 servo drives**

0.55 kW to 132 kW (0.75 hp to 150 hp)

**Air-cooled PM240-2 Power Modules in blocksize format****Technical specifications**

Mechanical specifications			
<b>Degree of protection</b> acc. to EN 60529	IP20		
<b>Protection class</b>	I		
<ul style="list-style-type: none"> <li>Line circuits with protective conductor connection according to IEC/EN 61800-5-1</li> <li>Electronic circuits</li> </ul>	Safety extra low-voltage PELV/SELV		
<b>Type of cooling</b>	Forced air cooling AF to EN 60146		
<b>Ambient conditions</b>			
	<b>Storage</b>	<b>Transport</b>	<b>Operation</b>
<b>Ambient temperature</b>	In product packaging Class 1K4 acc. to IEC 60721-3-3: 2002 -25 ... +55 °C (-13 ... +131 °F)	In transport packaging Class 2K4 acc. to IEC 60721-3-2: 1997 -40 ... +70 °C (-40 ... +158 °F)	Class 3K3 <sup>1)</sup> acc. to IEC 60721-3-3: 2002 For operation without derating <sup>2)</sup> : -10 ... +40 °C (14 ... 104 °F) (for operation with low overload) -10 ... +50 °C (14 ... 122 °F) (for operation with high overload) For operation with derating: >40 ... +60 °C (>104 ... 140 °F)
<b>Relative humidity</b> (oil mist, ice, condensation, dripping water, spraying water and water jets are not permitted)	Class 1K4 acc. to IEC 60721-3-1: 1997 5 ... 95 %	Class 2K3 acc. to IEC 60721-3-2: 1997 5 ... 95 % at 40 °C (104 °F)	Class 3K3 <sup>1)</sup> acc. to IEC 60721-3-3: 2002 5 ... 95 %
<b>Environmental class/harmful chemical substances</b>	Class 1C2 acc. to IEC 60721-3-1: 1997	Class 2C2 acc. to IEC 60721-3-2: 1997	Class 3C2 acc. to IEC 60721-3-3: 2002
<b>Organic/biological influences</b>	Class 1B1 acc. to IEC 60721-3-1: 1997	Class 2B1 acc. to IEC 60721-3-2: 1997	Class 3B1 acc. to IEC 60721-3-3: 2002
<b>Degree of pollution</b> acc. to IEC/EN 61800-5-1 (condensation not permissible)	2		
<b>Installation altitude</b>	<ul style="list-style-type: none"> <li>For operation with low overload Up to 1000 m (3281 ft) above sea level without derating</li> <li>For operation with high overload Up to 2000 m (6562 ft) above sea level without derating</li> <li>From 2000 m (6562 ft) up to 4000 m (13124 ft) above sea level observe the derating characteristics <a href="#">See characteristic for current derating as a function of the installation altitude and/or reduction of the ambient temperature by 3.5 K per 500 m (1640 ft)</a></li> </ul>		
<b>Mechanical strength</b>			
	<b>Storage</b>	<b>Transport</b>	<b>Operation</b>
<b>Vibratory load</b>	In product packaging Class 1M2 acc. to IEC 60721-3-1: 1997	In transport packaging Class 2M3 acc. to IEC 60721-3-2: 1997	Class 3M1 acc. to IEC 60721-3-3: 2002 Test values acc. to EN 60068-2-6
<b>Shock load</b>	Class 1M2 acc. to IEC 60721-3-1: 1997	Class 2M3 acc. to IEC 60721-3-2: 1997	Class 3M1 acc. to IEC 60721-3-3: 2002 Test values acc. to EN 60068-2-27
<b>Certificates</b>			
<b>Declarations of conformity</b>	CE (Low Voltage, EMC and Machinery Directives); Eco-design requirements of EU Directive 2019/1781		
<b>Certificates of suitability</b>	<ul style="list-style-type: none"> <li>Blocksize format FSA ... FSC UKCA; cULus according to UL 61800-5-1; CSA only with external surge voltage protection device; RCM; SEMI F47 KC (only with internal or external line filters of Category C2); RoHS; EAC</li> <li>Blocksize format FSD ... FSF UKCA; cULus acc. to UL 61800-5-1; CSA only with external surge voltage protection device; RCM; SEMI F47 KC (only with internal or external line filters of Category C2); RoHS; EAC WEEE (Waste Electrical &amp; Electronic Equipment)</li> </ul>		

<sup>1)</sup> Better than 3K3 through increased ruggedness regarding the temperature range and humidity.

<sup>2)</sup> Also carefully observe the permissible temperatures for the Control Unit and where relevant, the operator panel.

# SINAMICS S110 servo drives

0.55 kW to 132 kW (0.75 hp to 150 hp)

## Air-cooled PM240-2 Power Modules in blocksize format

### Technical specifications

#### PM240-2 Power Modules standard variant

Line voltage 200 ... 240 V 1 AC/3 AC		PM240-2 Power Modules standard variant				
Without integrated line filter		6SL3210-1PB13-0UL0	6SL3210-1PB13-8UL0	6SL3210-1PB15-5UL0	6SL3210-1PB17-4UL0	6SL3210-1PB21-0UL0
With integrated line filter class A		6SL3210-1PB13-0AL0	6SL3210-1PB13-8AL0	6SL3210-1PB15-5AL0	6SL3210-1PB17-4AL0	6SL3210-1PB21-0AL0
<b>Output current</b> at 50 Hz 230 V 1 AC						
• Rated current $I_N$ <sup>1)</sup>	A	3.2	4.2	6	7.4	10.4
• For S6 duty (40 %) $I_{S6}$	A	3.3	4.3	6.1	8.2	11.5
• Base-load current $I_H$ <sup>2)</sup>	A	2.3	3.2	4.2	6	7.4
• Maximum current $I_{max}$	A	4.6	6	8.3	11.1	15.6
<b>Type rating</b>						
• Based on $I_N$	kW (hp)	0.55 (0.75)	0.75 (1)	1.1 (1.5)	1.5 (2)	2.2 (3)
• Based on $I_H$	kW (hp)	0.37 (0.5)	0.55 (0.75)	0.75 (1)	1.1 (1.5)	1.5 (2)
<b>Rated pulse frequency</b>	kHz	4	4	4	4	4
<b>Efficiency <math>\eta</math></b> acc. to IEC 61800-9-2	%	>96.2	>96.4	>96.7	>96.4	>96.3
<b>Power loss<sup>3)</sup></b> acc. to IEC 61800-9-2 at rated current	kW	0.037	0.047	0.062	0.083	0.121
<b>Cooling air requirement</b>	m <sup>3</sup> /s (ft <sup>3</sup> /s)	0.005 (0.18)	0.005 (0.18)	0.0092 (0.325)	0.0092 (0.325)	0.0092 (0.325)
<b>Sound pressure level</b> $L_{pA}$ (1 m)	dB	<50	<50	<62	<62	<62
<b>Input current<sup>4)</sup></b>						
• Rated current 1 AC/3 AC	A	7.5/4.3	9.6/5.5	13.5/7.8	18.1/10.5	24/13.9
• Based on $I_H$ 1 AC/3 AC	A	6.6/3.8	8.4/4.8	11.8/6.8	15.8/9.1	20.9/12.1
<b>Line supply connection</b> U1/L1, V1/L2, W1/L3						
• Conductor cross-section	mm <sup>2</sup>	1.5 ... 2.5	1.5 ... 2.5	1.5 ... 6	1.5 ... 6	1.5 ... 6
<b>Motor connection</b> U2, V2, W2						
• Conductor cross-section	mm <sup>2</sup>	1.5 ... 2.5	1.5 ... 2.5	1.5 ... 6	1.5 ... 6	1.5 ... 6
<b>PE connection</b>						
		Included in terminal connector	Included in terminal connector	Included in terminal connector	Included in terminal connector	Included in terminal connector
<b>Motor cable length, max.</b>						
• Shielded	m (ft)	50 (164)	50 (164)	50 (164)	50 (164)	50 (164)
• Unshielded	m (ft)	100 (328)	100 (328)	100 (328)	100 (328)	100 (328)
<b>Degree of protection</b>						
		IP20	IP20	IP20	IP20	IP20
<b>Dimensions</b>						
• Width	mm (in)	73 (2.87)	73 (2.87)	100 (3.94)	100 (3.94)	100 (3.94)
• Height	mm (in)	196 (7.72)	196 (7.72)	292 (11.5)	292 (11.5)	292 (11.5)
• Depth without operator panel	mm (in)	165 (6.50)	165 (6.50)	165 (6.50)	165 (6.50)	165 (6.50)
<b>Frame size</b>						
		FSA	FSA	FSB	FSB	FSB
<b>Weight, approx.</b>						
• Without integrated line filter	kg (lb)	1.4 (3.09)	1.4 (3.09)	2.9 (6.39)	2.9 (6.39)	2.9 (6.39)
• With integrated line filter	kg (lb)	1.6 (3.53)	1.6 (3.53)	3.1 (6.84)	3.1 (6.84)	3.1 (6.84)

<sup>1)</sup> The rated output current  $I_N$  is based on the duty cycle for low overload (LO).

<sup>2)</sup> The base-load current  $I_H$  is based on the duty cycle for high overload (HO).

<sup>3)</sup> Typical values. More information can be found on the internet at <https://support.industry.siemens.com/cs/document/94059311>

<sup>4)</sup> The input current depends on the motor load and line impedance. The input currents apply for a load with the type rating (based on  $I_N$ ) for a line impedance corresponding to  $u_k = 1\%$ . The current values are specified on the rating plate of the Power Module.

**SINAMICS S110 servo drives**

0.55 kW to 132 kW (0.75 hp to 150 hp)

**Air-cooled PM240-2 Power Modules in blocksize format****Technical specifications**

<b>Line voltage 200 ... 240 V 1 AC/3 AC</b>		<b>PM240-2 Power Modules standard variant</b>	
Without integrated line filter		6SL3210-1PB21-4UL0	6SL3210-1PB21-8UL0
With integrated line filter class A		6SL3210-1PB21-4AL0	6SL3210-1PB21-8AL0
<b>Output current</b>			
at 50 Hz 230 V 1 AC			
• Rated current $I_N$ <sup>1)</sup>	A	13.6	17.5
• For S6 duty (40 %) $I_{S6}$	A	15	19.3
• Base-load current $I_H$ <sup>2)</sup>	A	10.4	13.6
• Maximum current $I_{max}$	A	20.8	27.2
<b>Type rating</b>			
• Based on $I_N$	kW (hp)	3 (4)	4 (5)
• Based on $I_H$	kW (hp)	2.2 (3)	3 (4)
<b>Rated pulse frequency</b>	kHz	4	4
<b>Efficiency <math>\eta</math></b> acc. to IEC 61800-9-2	%	>96.7	>96.7
<b>Power loss<sup>3)</sup></b> acc. to IEC 61800-9-2 at rated current	kW	0.139	0.179
<b>Cooling air requirement</b>	m <sup>3</sup> /s (ft <sup>3</sup> /s)	0.0185 (0.65)	0.0185 (0.65)
<b>Sound pressure level</b> $L_{pA}$ (1 m)	dB	<65	<65
<b>Input current<sup>4)</sup></b>			
• Rated current 1 AC/3 AC	A	35.9/20.7	43/24.8
• Based on $I_H$ 1 AC/3 AC	A	31.3/18.1	37.5/21.7
<b>Line supply connection</b> U1/L1, V1/L2, W1/L3			
• Conductor cross-section	mm <sup>2</sup>	6 ... 16	6 ... 16
<b>Motor connection</b> U2, V2, W2			
• Conductor cross-section	mm <sup>2</sup>	6 ... 16	6 ... 16
<b>PE connection</b>		Included in terminal connector	Included in terminal connector
<b>Motor cable length, max.</b>			
• Shielded	m (ft)	50 (164)	50 (164)
• Unshielded	m (ft)	100 (328)	100 (328)
<b>Degree of protection</b>		IP20	IP20
<b>Dimensions</b>			
• Width	mm (in)	140 (5.51)	140 (5.51)
• Height	mm (in)	355 (13.98)	355 (13.98)
• Depth without operator panel	mm (in)	165 (6.50)	165 (6.50)
<b>Frame size</b>		FSC	FSC
<b>Weight, approx.</b>			
• Without integrated line filter	kg (lb)	5 (11)	5 (11)
• With integrated line filter	kg (lb)	5.2 (11.5)	5.2 (11.5)

<sup>1)</sup> The rated output current  $I_N$  is based on the duty cycle for low overload (LO).

<sup>2)</sup> The base-load current  $I_H$  is based on the duty cycle for high overload (HO).

<sup>3)</sup> Typical values. More information can be found on the internet at <https://support.industry.siemens.com/cs/document/94059311>

<sup>4)</sup> The input current depends on the motor load and line impedance. The input currents apply for a load with the type rating (based on  $I_N$ ) for a line impedance corresponding to  $u_k = 1\%$ . The current values are specified on the rating plate of the Power Module.

# SINAMICS S110 servo drives

0.55 kW to 132 kW (0.75 hp to 150 hp)

## Air-cooled PM240-2 Power Modules in blocksize format

### Technical specifications

Line voltage 380 ... 480 V 3 AC		PM240-2 Power Modules standard variant					
Without integrated line filter		6SL3210-1PE11-8UL1	6SL3210-1PE12-3UL1	6SL3210-1PE13-2UL1	6SL3210-1PE14-3UL1	6SL3210-1PE16-1UL1	6SL3210-1PE18-0UL1
With integrated line filter class A		6SL3210-1PE11-8AL1	6SL3210-1PE12-3AL1	6SL3210-1PE13-2AL1	6SL3210-1PE14-3AL1	6SL3210-1PE16-1AL1	6SL3210-1PE18-0AL1
<b>Output current</b> at 50 Hz 400 V 3 AC							
• Rated current $I_N^{1)}$	A	1.7	2.2	3.1	4.1	5.9	7.7
• For S6 duty (40 %) $I_{S6}$	A	2	2.5	3.5	4.5	6.5	8.5
• Base-load current $I_H^{2)}$	A	1.3	1.7	2.2	3.1	4.1	5.9
• Maximum current $I_{max}$	A	2.6	3.4	4.7	6.2	8.9	11.8
<b>Type rating</b>							
• Based on $I_N$	kW (hp)	0.55 (0.75)	0.75 (1)	1.1 (1.5)	1.5 (2)	2.2 (3)	3 (4)
• Based on $I_H$	kW (hp)	0.37 (0.5)	0.55 (0.75)	0.75 (1)	1.1 (1.5)	1.5 (2)	2.2 (3)
<b>Rated pulse frequency</b> acc. to IEC 61800-9-2	kHz	4	4	4	4	4	4
<b>Efficiency <math>\eta</math></b>	%	>96.0	>96.7	>97.1	>97.3	>97.3	>97.3
<b>Power loss <sup>3)</sup></b> acc. to IEC 61800-9-2 at rated current	kW	0.032	0.038	0.047	0.059	0.082	0.107
<b>Cooling air requirement</b>	m <sup>3</sup> /s (ft <sup>3</sup> /s)	0.005 (0.18)	0.005 (0.18)	0.005 (0.18)	0.005 (0.18)	0.005 (0.18)	0.005 (0.18)
<b>Sound pressure level</b> $L_{pA}$ (1 m)	dB	<50	<50	<50	<50	<57	<57
<b>Input current <sup>4)</sup></b>							
• Rated current	A	2.3	2.9	4.1	5.5	7.7	10.1
• Based on $I_H$	A	2	2.6	3.3	4.7	6.1	8.8
<b>Line supply connection</b> U1/L1, V1/L2, W1/L3		Terminal connector	Terminal connector	Terminal connector	Terminal connector	Terminal connector	Terminal connector
• Conductor cross-section	mm <sup>2</sup>	1 ... 2.5	1 ... 2.5	1 ... 2.5	1 ... 2.5	1 ... 2.5	1 ... 2.5
<b>Motor connection</b> U2, V2, W2		Terminal connector	Terminal connector	Terminal connector	Terminal connector	Terminal connector	Terminal connector
• Conductor cross-section	mm <sup>2</sup>	1 ... 2.5	1 ... 2.5	1 ... 2.5	1 ... 2.5	1 ... 2.5	1 ... 2.5
<b>PE connection</b>		Included in terminal connector	Included in terminal connector	Included in terminal connector	Included in terminal connector	Included in terminal connector	Included in terminal connector
<b>Motor cable length, max.</b>							
• Without filter, shielded/unshielded	m (ft)	150/150 (492/492)	150/150 (492/492)	150/150 (492/492)	150/150 (492/492)	150/150 (492/492)	150/150 (492/492)
• With integrated filter class A, shielded/unshielded	m (ft)	50/100 (164/328)	50/100 (164/328)	50/100 (164/328)	50/100 (164/328)	50/100 (164/328)	50/100 (164/328)
<b>Degree of protection</b>		IP20	IP20	IP20	IP20	IP20	IP20
<b>Dimensions</b>							
• Width	mm (in)	73 (2.87)	73 (2.87)	73 (2.87)	73 (2.87)	73 (2.87)	73 (2.87)
• Height	mm (in)	196 (7.72)	196 (7.72)	196 (7.72)	196 (7.72)	196 (7.72)	196 (7.72)
• Depth without operator panel	mm (in)	165 (6.50)	165 (6.50)	165 (6.50)	165 (6.50)	165 (6.50)	165 (6.50)
<b>Frame size</b>		FSA	FSA	FSA	FSA	FSA	FSA
<b>Weight, approx.</b>							
• Without integrated line filter	kg (lb)	1.3 (2.87)	1.3 (2.87)	1.3 (2.87)	1.4 (3.09)	1.4 (3.09)	1.4 (3.09)
• With integrated line filter	kg (lb)	1.5 (3.31)	1.5 (2.01)	1.5 (2.01)	1.6 (3.53)	1.6 (3.53)	1.6 (3.53)

<sup>1)</sup> The rated output current  $I_N$  is based on the duty cycle for low overload (LO).

<sup>2)</sup> The base-load current  $I_H$  is based on the duty cycle for high overload (HO).

<sup>3)</sup> Typical values. More information can be found on the internet at <https://support.industry.siemens.com/cs/document/94059311>

<sup>4)</sup> The input current depends on the motor load and line impedance. The input currents apply for a load with the type rating (based on  $I_N$ ) for a line impedance corresponding to  $u_k = 1\%$ . The current values are specified on the rating plate of the Power Module.

## SINAMICS S110 servo drives

0.55 kW to 132 kW (0.75 hp to 150 hp)

### Air-cooled PM240-2 Power Modules in blocksize format

#### Technical specifications

Line voltage 380 ... 480 V 3 AC		PM240-2 Power Modules standard variant				
Without integrated line filter		6SL3210-1PE21-1UL0	6SL3210-1PE21-4UL0	6SL3210-1PE21-8UL0	6SL3210-1PE22-7UL0	6SL3210-1PE23-3UL0
With integrated line filter class A		6SL3210-1PE21-1AL0	6SL3210-1PE21-4AL0	6SL3210-1PE21-8AL0	6SL3210-1PE22-7AL0	6SL3210-1PE23-3AL0
<b>Output current</b> at 50 Hz 400 V 3 AC						
• Rated current $I_N^{1)}$	A	10.2	13.2	18	26	32
• For S6 duty (40 %) $I_{S6}$	A	11.2	14.5	19.8	28.6	37.1
• Base-load current $I_H^{2)}$	A	7.7	10.2	13.2	18	26
• Maximum current $I_{max}$	A	15.4	20.4	27	39	52
<b>Type rating</b>						
• Based on $I_N$	kW (hp)	4 (5)	5.5 (7.5)	7.5 (10)	11 (15)	15 (20)
• Based on $I_H$	kW (hp)	3 (4)	4 (5)	5.5 (7.5)	7.5 (10)	11 (15)
<b>Rated pulse frequency</b>	kHz	4	4	4	4	4
<b>Efficiency <math>\eta</math></b> acc. to IEC 61800-9-2	%	>97.4	>97.6	>97.7	>97.8	>97.9
<b>Power loss <sup>3)</sup></b> acc. to IEC 61800-9-2 at rated current	kW	0.138	0.180	0.236	0.320	0.375
<b>Cooling air requirement</b>	m <sup>3</sup> /s (ft <sup>3</sup> /s)	0.0092 (0.325)	0.0092 (0.325)	0.0092 (0.325)	0.0185 (0.65)	0.0185 (0.65)
<b>Sound pressure level</b> $L_{pA}$ (1 m)	dB	<62	<62	<62	<65	<65
<b>Input current <sup>4)</sup></b>						
• Rated current	A	13.3	17.2	22.2	32.6	39.9
• Based on $I_H$	A	11.6	15.3	19.8	27	36
<b>Line supply connection</b> U1/L1, V1/L2, W1/L3						
• Conductor cross-section	mm <sup>2</sup>	1.5 ... 6	1.5 ... 6	1.5 ... 6	6 ... 16	6 ... 16
<b>Motor connection</b> U2, V2, W2						
• Conductor cross-section	mm <sup>2</sup>	1.5 ... 6	1.5 ... 6	1.5 ... 6	6 ... 16	6 ... 16
<b>PE connection</b>						
		Included in terminal connector	Included in terminal connector	Included in terminal connector	Included in terminal connector	Included in terminal connector
<b>Motor cable length, max.</b>						
• Without filter, shielded/unshielded	m (ft)	150/150 (492/492)	150/150 (492/492)	150/150 (492/492)	150/150 (492/492)	150/150 (492/492)
• With integrated filter class A, shielded/unshielded	m (ft)	100/100 (328/328) <sup>5)</sup>	100/100 (328/328) <sup>5)</sup>	100/100 (328/328) <sup>5)</sup>	150/150 (492/492) <sup>5)</sup>	150/150 (492/492) <sup>5)</sup>
<b>Degree of protection</b>						
		IP20	IP20	IP20	IP20	IP20
<b>Dimensions</b>						
• Width	mm (in)	100 (3.94)	100 (3.94)	100 (3.94)	140 (5.51)	140 (5.51)
• Height	mm (in)	292 (11.5)	292 (11.5)	292 (11.5)	355 (13.98)	355 (13.98)
• Depth without operator panel	mm (in)	165 (6.50)	165 (6.50)	165 (6.50)	165 (6.50)	165 (6.50)
<b>Frame size</b>						
		FSB	FSB	FSB	FSC	FSC
<b>Weight, approx.</b>						
• Without integrated line filter	kg (lb)	2.9 (6.39)	2.9 (6.39)	3 (6.62)	4.7 (10.4)	4.8 (10.6)
• With integrated line filter	kg (lb)	3.1 (6.84)	3.1 (6.84)	3.2 (7.06)	5.3 (11.7)	5.4 (11.91)

<sup>1)</sup> The rated output current  $I_N$  is based on the duty cycle for low overload (LO).

<sup>2)</sup> The base-load current  $I_H$  is based on the duty cycle for high overload (HO).

<sup>3)</sup> Typical values. More information can be found on the internet at <https://support.industry.siemens.com/cs/document/94059311>

<sup>4)</sup> The input current depends on the motor load and line impedance. The input currents apply for a load with the type rating (based on  $I_N$ ) for a line impedance corresponding to  $u_k = 1\%$ . The current values are specified on the rating plate of the Power Module.

<sup>5)</sup> The values are applicable for low capacitance cables, e.g. MOTION-CONNECT. For standard CY cables the max. permissible motor cable length is 50 m (164 ft) (shielded) and 100 m (328 ft) (unshielded).

# SINAMICS S110 servo drives

0.55 kW to 132 kW (0.75 hp to 150 hp)

## Air-cooled PM240-2 Power Modules in blocksize format

### Technical specifications

Line voltage 380 ... 480 V 3 AC		PM240-2 Power Modules standard variant					
		6SL3210-1PE23-8U0L0	6SL3210-1PE24-5U0L0	6SL3210-1PE26-0U0L0	6SL3210-1PE27-5U0L0	6SL3210-1PE28-8U0L0	6SL3210-1PE31-1U0L0
Without integrated line filter							
With integrated line filter class A		6SL3210-1PE23-8AL0	6SL3210-1PE24-5AL0	6SL3210-1PE26-0AL0	6SL3210-1PE27-5AL0	6SL3210-1PE28-8AL0	6SL3210-1PE31-1AL0
<b>Output current</b> at 50 Hz 400 V 3 AC							
• Rated current $I_N^{1)}$	A	38	45	60	75	90	110
• For S6 duty (40 %) $I_{S6}$	A	45	54	72	90	108	132
• Base-load current $I_H^{2)}$	A	32	38	45	60	75	90
• Maximum current $I_{max}$	A	64	76	90	120	150	180
<b>Type rating</b>							
• Based on $I_N$	kW (hp)	18.5 (25)	22 (30)	30 (40)	37 (50)	45 (60)	55 (75)
• Based on $I_H$	kW (hp)	15 (20)	18.5 (25)	22 (30)	30 (40)	37 (50)	45 (60)
<b>Rated pulse frequency</b>		kHz	4	4	4	4	4
<b>Efficiency <math>\eta</math></b> acc. to IEC 61800-9-2		%	>97.2	>97.2	>97.5	>97.3	>97.4
<b>Power loss <sup>3)</sup></b> acc. to IEC 61800-9-2 at rated current							
• Without integrated line filter	kW	0.584	0.713	0.848	1.12	1.31	1.69
• With integrated line filter	kW	0.587	0.716	0.854	1.13	1.32	1.70
<b>Cooling air requirement</b>		m <sup>3</sup> /s (ft <sup>3</sup> /s)	0.055 (1.94)	0.055 (1.94)	0.055 (1.94)	0.055 (1.94)	0.083 (2.93)
<b>Sound pressure level</b> $L_{pA}$ (1 m)		dB	45 ... 65 <sup>4)</sup>	45 ... 65 <sup>4)</sup>	45 ... 65 <sup>4)</sup>	45 ... 65 <sup>4)</sup>	44 ... 62 <sup>4)</sup>
<b>Input current <sup>5)</sup></b>							
• Rated current	A	36	42	57	70	86	104
• Based on $I_H$	A	33	38	47	62	78	94
<b>Line supply connection</b> U1/L1, V1/L2, W1/L3							
• Conductor cross-section	mm <sup>2</sup>	10 ... 35	10 ... 35	10 ... 35	10 ... 35	25 ... 70	25 ... 70
<b>Motor connection</b> U2, V2, W2							
• Conductor cross-section	mm <sup>2</sup>	10 ... 35	10 ... 35	10 ... 35	10 ... 35	25 ... 70	25 ... 70
<b>PE connection</b>							
		Screw terminals	Screw terminals	Screw terminals	Screw terminals	Screw terminals	Screw terminals
<b>Motor cable length, max.</b>							
• Shielded	m (ft)	200 (656)	200 (656)	200 (656)	200 (656)	200 (656)	200 (656)
• Unshielded	m (ft)	300 (984)	300 (984)	300 (984)	300 (984)	300 (984)	300 (984)
<b>Degree of protection</b>							
		IP20	IP20	IP20	IP20	IP20	IP20
<b>Dimensions</b>							
• Width	mm (in)	200 (7.87)	200 (7.87)	200 (7.87)	200 (7.87)	275 (10.83)	275 (10.83)
• Height	mm (in)	472 (18.58)	472 (18.58)	472 (18.58)	472 (18.58)	551 (21.69)	551 (21.69)
• Depth without operator panel	mm (in)	237 (9.33)	237 (9.33)	237 (9.33)	237 (9.33)	237 (9.33)	237 (9.33)
<b>Frame size</b>							
		FSD	FSD	FSD	FSD	FSE	FSE
<b>Weight, approx.</b>							
• Without integrated line filter	kg (lb)	16 (35.3)	16 (35.3)	17 (37.5)	17 (37.5)	26 (57.3)	26 (57.3)
• With integrated line filter	kg (lb)	17.5 (38.6)	17.5 (38.6)	18.5 (40.8)	18.5 (40.8)	28 (61.7)	28 (61.7)

<sup>1)</sup> The rated output current  $I_N$  is based on the duty cycle for low overload (LO).

<sup>2)</sup> The base-load current  $I_H$  is based on the duty cycle for high overload (HO).

<sup>3)</sup> Typical values. More information can be found on the internet at <https://support.industry.siemens.com/cs/document/94059311>

<sup>4)</sup> Values dependent on ambient temperature and utilization.

<sup>5)</sup> The input current depends on the motor load and line impedance. The input currents apply for a load with the type rating (based on  $I_N$ ) for a line impedance corresponding to  $u_k = 1\%$ . The current values are specified on the rating plate of the Power Module.

**SINAMICS S110 servo drives**

0.55 kW to 132 kW (0.75 hp to 150 hp)

**Air-cooled PM240-2 Power Modules in blocksize format****Technical specifications**

Line voltage 380 ... 480 V 3 AC		PM240-2 Power Modules standard variant			
		6SL3210-1PE31-5ULO	6SL3210-1PE31-8ULO	6SL3210-1PE32-1ULO	6SL3210-1PE32-5ULO
Without integrated line filter		6SL3210-1PE31-5ALO	6SL3210-1PE31-8ALO	6SL3210-1PE32-1ALO	6SL3210-1PE32-5ALO
With integrated line filter class A		6SL3210-1PE31-5ALO	6SL3210-1PE31-8ALO	6SL3210-1PE32-1ALO	6SL3210-1PE32-5ALO
<b>Output current</b>					
at 50 Hz 400 V 3 AC					
• Rated current $I_N^{1)}$	A	145	178	205	250
• For S6 duty (40 %) $I_{S6}$	A	174	213	246	300
• Base-load current $I_H^{2)}$	A	110	145	178	205
• Maximum current $I_{max}$	A	220	290	356	410
<b>Type rating</b>					
• Based on $I_N$	kW (hp)	75 (100)	90 (125)	110 (150)	132 (200)
• Based on $I_H$	kW (hp)	55 (75)	75 (100)	90 (125)	110 (150)
<b>Rated pulse frequency</b>		kHz	2	2	2
<b>Efficiency <math>\eta</math></b>		%	>97.6	>97.4	>97.9
acc. to IEC 61800-9-2					>97.8
<b>Power loss <sup>3)</sup></b>					
acc. to IEC 61800-9-2 at rated current					
• Without integrated line filter	kW	1.97	2.56	2.37	3.10
• With integrated line filter	kW	1.98	2.58	2.39	3.14
<b>Cooling air requirement</b>		m <sup>3</sup> /s (ft <sup>3</sup> /s)	0.153 (5.40)	0.153 (5.40)	0.153 (5.40)
<b>Sound pressure level</b>		dB	56 ... 68 <sup>4)</sup>	56 ... 68 <sup>4)</sup>	56 ... 68 <sup>4)</sup>
$L_{pA}$ (1 m)					
<b>Input current <sup>5)</sup></b>					
• Rated current	A	140	172	198	242
• Based on $I_H$	A	117	154	189	218
<b>Line supply connection</b>			M10 screw stud	M10 screw stud	M10 screw stud
U1/L1, V1/L2, W1/L3					
• Conductor cross-section	mm <sup>2</sup>	35 ... 2 × 120	35 ... 2 × 120	35 ... 2 × 120	35 ... 2 × 120
<b>Motor connection</b>			M10 screw stud	M10 screw stud	M10 screw stud
U2, V2, W2					
• Conductor cross-section	mm <sup>2</sup>	35 ... 2 × 120	35 ... 2 × 120	35 ... 2 × 120	35 ... 2 × 120
<b>PE connection</b>			M10 screw stud	M10 screw stud	M10 screw stud
<b>Motor cable length, max.</b>					
• Shielded	m (ft)	300 (984)	300 (984)	300 (984)	300 (984)
• Unshielded	m (ft)	450 (1476)	450 (1476)	450 (1476)	450 (1476)
<b>Degree of protection</b>			IP20	IP20	IP20
<b>Dimensions</b>					
• Width	mm (in)	305 (12.01)	305 (12.01)	305 (12.01)	305 (12.01)
• Height	mm (in)	708 (27.87)	708 (27.87)	708 (27.87)	708 (27.87)
• Depth without operator panel	mm (in)	357 (14.06)	357 (14.06)	357 (14.06)	357 (14.06)
<b>Frame size</b>			FSF	FSF	FSF
<b>Weight, approx.</b>					
• Without integrated line filter	kg (lb)	57 (126)	57 (126)	61 (135)	61 (135)
• With integrated line filter	kg (lb)	63 (139)	63 (139)	65 (143)	65 (143)

<sup>1)</sup> The rated output current  $I_N$  is based on the duty cycle for low overload (LO).

<sup>2)</sup> The base-load current  $I_H$  is based on the duty cycle for high overload (HO).

<sup>3)</sup> Typical values. More information can be found on the internet at <https://support.industry.siemens.com/cs/document/94059311>

<sup>4)</sup> Values dependent on ambient temperature and utilization.

<sup>5)</sup> The input current depends on the motor load and line impedance. The input currents apply for a load with the type rating (based on  $I_N$ ) for a line impedance corresponding to  $u_k = 1\%$ . The current values are specified on the rating plate of the Power Module.



**Characteristic curves**

**Overload capability**

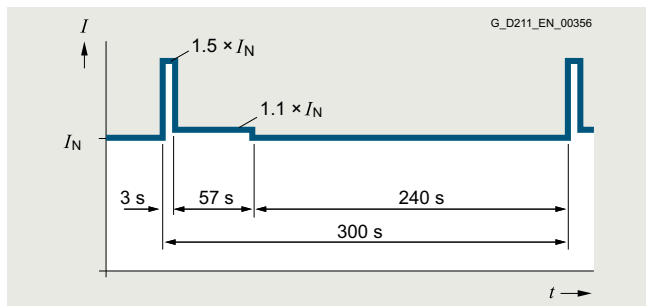

300 s duty cycle based on low overload

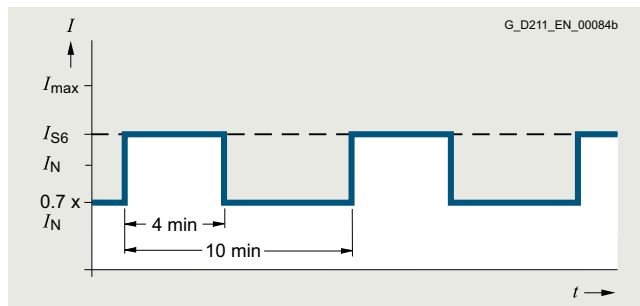

S6 duty cycle with initial load with a duty cycle duration of 600 s

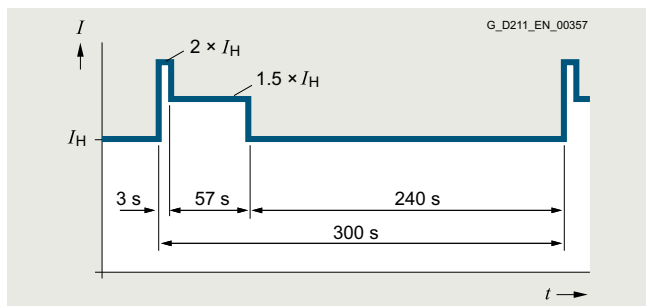

300 s duty cycle based on high overload

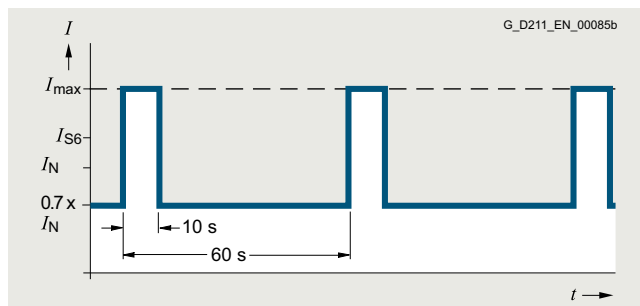

S6 duty cycle with initial load with a duty cycle duration of 60 s

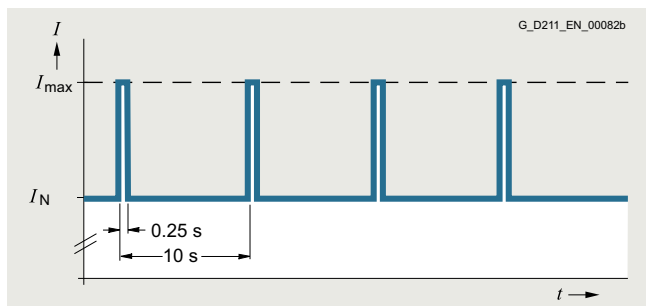

Duty cycle with initial load

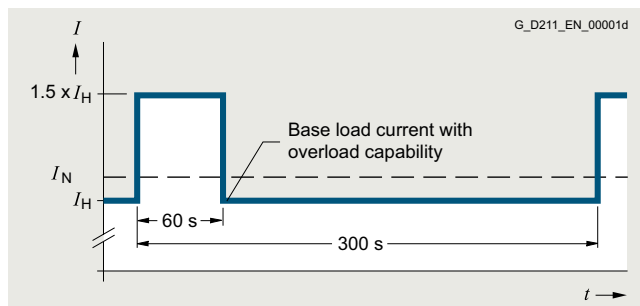

Duty cycle with 60 s overload with a duty cycle duration of 300 s

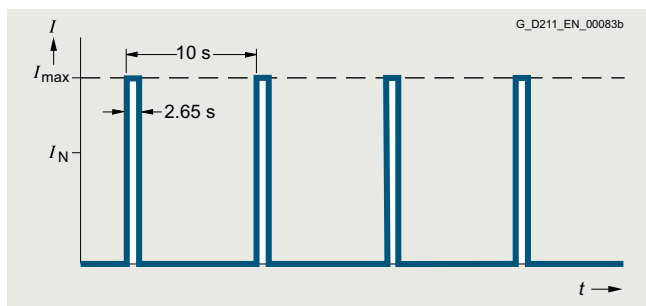

Duty cycle without initial load

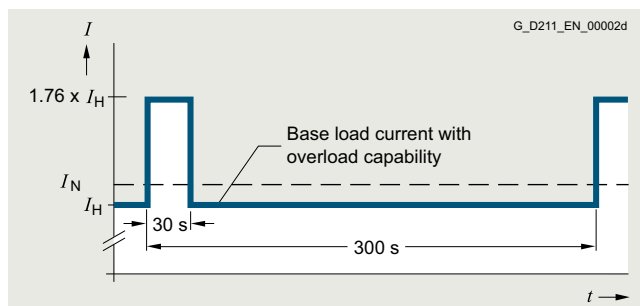

Duty cycle with 30 s overload with a duty cycle duration of 300 s

**SINAMICS S110 servo drives**

0.55 kW to 132 kW (0.75 hp to 150 hp)

**Air-cooled PM240-2 Power Modules in blocksize format****Characteristic curves****Derating data**Pulse frequency

Type rating <sup>1)</sup> at 50 Hz 200 V 1 AC/3 AC		Rated output current in A for a pulse frequency of							
kW	hp	2 kHz	4 kHz	6 kHz	8 kHz	10 kHz	12 kHz	14 kHz	16 kHz
0.55	0.75	3.2	3.2	2.7	2.2	1.9	1.6	1.4	1.3
0.75	1	4.2	4.2	3.6	2.9	2.5	2.1	1.9	1.7
1.1	1.5	6	6	5.1	4.2	3.6	3	2.7	2.4
1.5	2	7.4	7.4	6.3	5.2	4.4	3.7	3.3	3
2.2	3	10.4	10.4	8.8	7.3	6.2	5.2	4.7	4.2
3	4	13.6	13.6	11.6	9.5	8.2	6.8	6.1	5.4
4	5	17.5	17.5	14.9	12.3	10.5	8.8	7.9	7
5.5	7.5	22	22	18.7	15.4	13.2	11	9.9	8.8
7.5	10	28	28	23.8	19.6	16.8	14	12.6	11.2
11	15	42	42	35.7	29.4	25.2	21	18.9	16.8
15	20	54	54	45.9	37.8	32.4	27	24.3	21.6
18.5	25	68	68	57.8	47.6	40.8	34	30.6	27.2
22	30	80	80	68	56	48	40	36	32
30	40	104	104	88.4	72.8	62.4	52	46.8	41.6
37	50	130	130	110.5	91	–	–	–	–
45	60	154	154	130.9	107.8	–	–	–	–
55	75	178	178	151.3	124.6	–	–	–	–

Type rating <sup>1)</sup> at 50 Hz 400 V 3 AC		Rated output current in A for a pulse frequency of							
kW	hp	2 kHz	4 kHz	6 kHz	8 kHz	10 kHz	12 kHz	14 kHz	16 kHz
0.55	0.75	1.7	1.7	1.4	1.2	1	0.9	0.8	0.7
0.75	1	2.2	2.2	1.9	1.5	1.3	1.1	1	0.9
1.1	1.5	3.1	3.1	2.6	2.2	1.9	1.6	1.4	1.2
1.5	2	4.1	4.1	3.5	2.9	2.5	2.1	1.8	1.6
2.2	3	5.9	5.9	5	4.1	3.5	3	2.7	2.4
3	4	7.7	7.7	6.5	5.4	4.6	3.9	3.5	3.1
4	5	10.2	10.2	8.7	7.1	6.1	5.1	4.6	4.1
5.5	7.5	13.2	13.2	11.2	9.2	7.9	6.6	5.9	5.3
7.5	10	18	18	15.3	12.6	10.8	9	8.1	7.2
11	15	26	26	22.1	18.2	15.6	13	11.7	10.4
15	20	32	32	27.2	22.4	19.2	16	14.4	12.8
18.5	25	38	38	32.3	26.6	22.8	19	17.1	15.2
22	30	45	45	38.3	31.5	27	22.5	20.3	18
30	40	60	60	51	42	36	30	27	24
37	50	75	75	63.8	52.5	45	37.5	33.8	30
45	60	90	90	76.5	63	54	45	40.5	36
55	75	110	110	93.5	77	–	–	–	–
75	100	145	145	123.3	101.5	–	–	–	–
90	125	178	178	151.3	124.6	–	–	–	–
110	150	205	143.5	–	–	–	–	–	–
132	200	250	175	–	–	–	–	–	–

<sup>1)</sup> Type rating based on the rated output current  $I_N$ . The rated output current  $I_N$  is based on the duty cycle for low overload (LO).

### Characteristic curves

#### Derating data (continued)

##### Ambient temperature

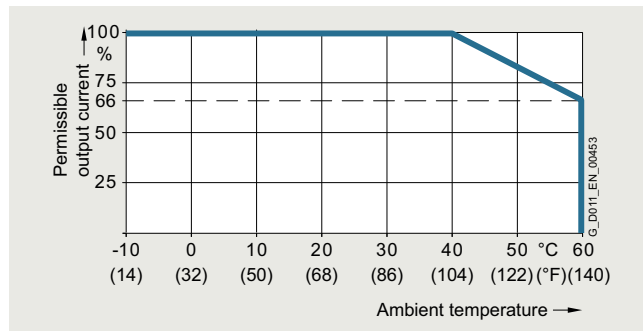

Permissible output current as a function of ambient temperature for low overload (LO) for PM240-2 Power Modules, frame sizes FSA to FSC

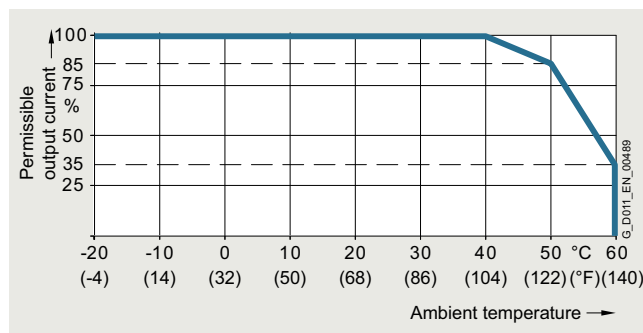

Permissible output current as a function of ambient temperature for low overload (LO) for PM240-2 Power Modules, frame sizes FSD to FSF

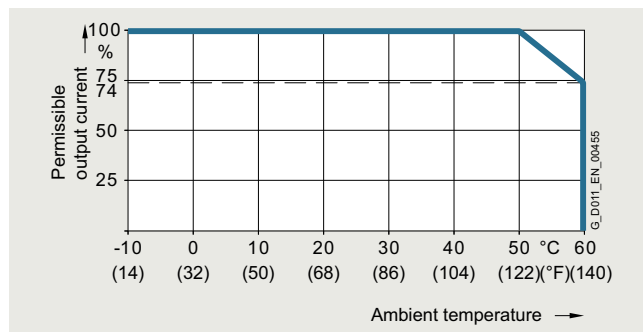

Permissible output current as a function of ambient temperature for high overload (HO) for PM240-2 Power Modules, frame sizes FSA to FSC

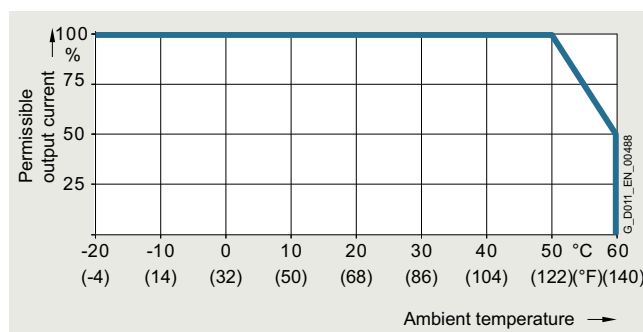

Permissible output current as a function of ambient temperature for high overload (HO) for PM240-2 Power Modules, frame sizes FSD to FSF

The operating temperature ranges of the Control Units should be taken into account.

##### Installation altitude

Permissible line supplies depending on the installation altitude

- Installation altitude up to 2000 m (6562 ft) above sea level
  - Connection to every supply system permitted for the converter
- Installation altitudes between 2000 m and 4000 m (6562 ft and 13124 ft) above sea level
  - Connection only to a TN system with grounded neutral point
  - TN systems with grounded line conductor are not permitted
  - The TN line system with grounded neutral point can also be supplied using an isolation transformer
  - The phase-to-phase voltage does not have to be reduced

The connected motors, power elements and components must be considered separately.

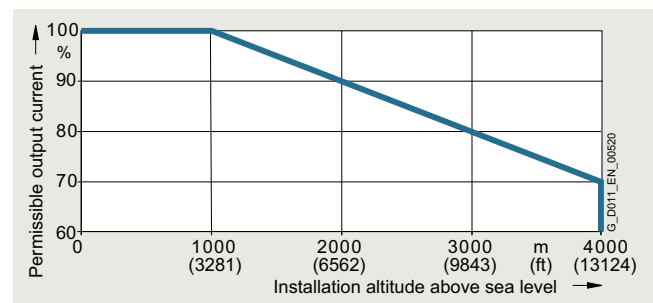

Permissible output current as a function of the installation altitude for PM240-2 Power Modules at 40 °C for low overload (LO)

##### System operating voltage

The rated output current remains constant over the 380 V to 480 V 3 AC voltage range.

More information on the derating data of the PM240-2 Power Modules is available in the Hardware Installation Manual on the internet at:

[www.siemens.com/sinamics-g120/documentation](http://www.siemens.com/sinamics-g120/documentation)

**SINAMICS S110 servo drives**

0.55 kW to 132 kW (0.75 hp to 150 hp)

**Line-side components > Line filters****Overview**

Line filter for PM240-2 Power Modules

With one of the additional line filters, the Power Module attains a higher radio interference class.

**Integration**

**Line filters that are optionally available depending on the Power Module used**

	Frame size					
	FSA	FSB	FSC	FSD	FSE	FSF
<b>PM240-2 Power Module with integrated braking chopper</b>						
<b>Line-side components</b>						
Line filter class A according to EN 55011	F	F	F	F <sup>1)</sup>	F <sup>1)</sup>	F <sup>1)</sup>
Line filter class B according to EN 55011 (only for 400 V versions)	U	U	U	–	–	–

F = Power Modules available with and without integrated filter class A

U = Base component

– = Not possible

**Selection and ordering data**

Type rating		PM240-2 Power Module		Line filter class B according to EN 55011	
kW	hp	standard variant	Type 6SL3210-...	Frame size	Article No.
<b>380 ... 480 V 3 AC</b>					
0.55	0.75	1PE11-8UL1		FSA	<b>6SL3203-0BE17-7BA0</b>
0.75	1	1PE12-3UL1			
1.1	1.5	1PE13-2UL1			
1.5	2	1PE14-3UL1			
2.2	3	1PE16-1UL1			
3	4	1PE18-0UL1			
4	5	1PE21-1UL0		FSB	<b>6SL3203-0BE21-8BA0</b>
5.5	7.5	1PE21-4UL0			
7.5	10	1PE21-8UL0			
11	15	1PE22-7UL0		FSC	<b>6SL3203-0BE23-8BA0</b>
15	20	1PE23-3UL0			

<sup>1)</sup> PM240-2 200 V versions, frame sizes FSD to FSF are only available without integrated line filter.

## SINAMICS S110 servo drives

0.55 kW to 132 kW (0.75 hp to 150 hp)

### Line-side components > Line filters

#### Technical specifications

Line voltage 380 ... 480 V 3 AC		Line filter class B		
		6SL3203-0BE17-7BA0	6SL3203-0BE21-8BA0	6SL3203-0BE23-8BA0
<b>Rated current</b>	A	11.4	23.5	49.4
<b>Pulse frequency</b>	kHz	4 ... 16	4 ... 16	4 ... 16
<b>Line supply connection</b> L1, L2, L3		Screw terminals	Screw terminals	Screw terminals
• Conductor cross-section	mm <sup>2</sup>	1 ... 2.5	2.5 ... 6	6 ... 16
<b>Load connection</b> U, V, W		Shielded cable	Shielded cable	Shielded cable
• Cable cross-section	mm <sup>2</sup>	1.5	4	10
• Length	m (ft)	0.45 (1.48)	0.5 (1.64)	0.54 (1.77)
<b>PE connection</b>		On housing via M5 screw stud	On housing via M5 screw stud	On housing via M6 screw studs
• Conductor cross-section	mm <sup>2</sup>	1 ... 2.5	2.5 ... 6	6 ... 16
<b>Degree of protection</b>		IP20	IP20	IP20
<b>Dimensions</b>				
• Width	mm (in)	73 (2.87)	100 (3.94)	140 (5.51)
• Height	mm (in)	202 (7.95)	297 (11.69)	359 (14.13)
• Depth	mm (in)	65 (2.56)	85 (3.35)	95 (3.74)
<b>Possible as base component</b>		Yes	Yes	Yes
<b>Weight, approx.</b>	kg (lb)	1.75 (3.86)	4 (8.82)	7.3 (16.1)
<b>Suitable for PM240-2 Power Module standard variant 380 ... 480 V 3 AC</b>	Type	6SL3210-1PE11-8UL1 6SL3210-1PE12-3UL1 6SL3210-1PE13-2UL1 6SL3210-1PE14-3UL1 6SL3210-1PE16-1UL1 6SL3210-1PE18-0UL1	6SL3210-1PE21-1UL0 6SL3210-1PE21-4UL0 6SL3210-1PE21-8UL0	6SL3210-1PE22-7UL0 6SL3210-1PE23-3UL0
• Frame size		FSA	FSB	FSC

## SINAMICS S110 servo drives

0.55 kW to 132 kW (0.75 hp to 150 hp)

### Line-side components > Line reactors

#### Overview

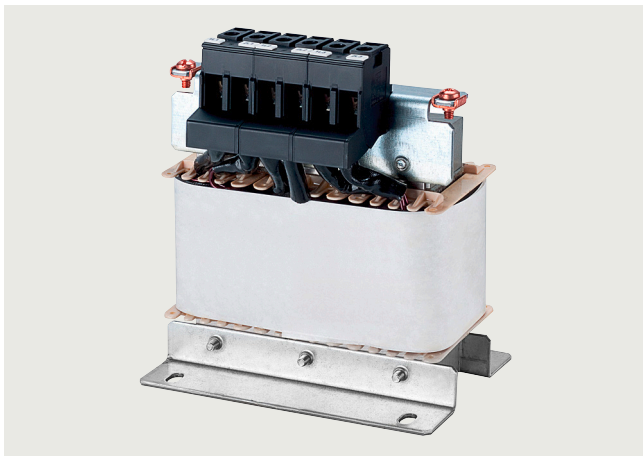

Line reactor for PM240-2 Power Modules, frame size FSA

Line reactors smooth the current drawn by the converter and thus reduce harmonic components in the line current. Through the reduction of the current harmonics, the thermal load on the power components in the rectifier and in the DC link capacitors is reduced as well as the harmonic effects on the supply. The use of a line reactor increases the service life of the converter.

#### Integration

A DC link reactor is integrated in the PM240-2 Power Modules, frame sizes FSD to FSF, and therefore no line reactor is required.

#### Line reactors that are optionally available depending on the Power Module used

	Frame size					
	FSA	FSB	FSC	FSD	FSE	FSF
<b>PM240-2 Power Module with integrated braking chopper</b>						
<b>Line-side components</b>						
Line reactor (only for 3 AC versions <sup>1)</sup> )	S <sup>2)</sup>	S <sup>2)</sup>	S <sup>2)</sup>	I	I	I

S = Lateral mounting

I = Integrated

#### Selection and ordering data

Type rating		PM240-2 Power Module	Line reactor
kW	hp	standard variant Type 6SL3210-...	Article No.
200 ... 240 V 3 AC <sup>1)</sup>			
0.55	0.75	1PB13-0 . L0	6SL3203-0CE13-2AA0
0.75	1	1PB13-8 . L0	
1.1	1.5	1PB15-5 . L0	6SL3203-0CE21-0AA0
1.5	2	1PB17-4 . L0	
2.2	3	1PB21-0 . L0	6SL3203-0CE21-8AA0
3	4	1PB21-4 . L0	
4	5	1PB21-8 . L0	

<sup>1)</sup> With the appropriate wiring, the line reactors for 200 V 3 AC can be used for the 200 V versions for 200 V 1 AC. More information can be found on the internet at:  
<https://support.industry.siemens.com/cs/document/109486005>  
<https://support.industry.siemens.com/cs/document/109482011>

<sup>2)</sup> For frame sizes FSA to FSC, for lines with  $u_k < 1\%$ , it is recommended that you use a line reactor or the next more powerful Power Module. More information can be found on the internet at:  
<https://support.industry.siemens.com/cs/document/109482011>

## SINAMICS S110 servo drives

0.55 kW to 132 kW (0.75 hp to 150 hp)

### Line-side components > Line reactors

#### Selection and ordering data

Type rating		PM240-2 Power Module		Line reactor
kW	hp	standard variant	Frame size	Article No.
380 ... 480 V 3 AC		Type 6SL3210-...		
0.55	0.75	1PE11-8 . L1	FSA	6SL3203-0CE13-2AA0
0.75	1	1PE12-3 . L1		
1.1	1.5	1PE13-2 . L1		
1.5	2	1PE14-3 . L1	FSA	6SL3203-0CE21-0AA0
2.2	3	1PE16-1 . L1		
3	4	1PE18-0 . L1		
4	5	1PE21-1 . L0	FSB	6SL3203-0CE21-8AA0
5.5	7.5	1PE21-4 . L0		
7.5	10	1PE21-8 . L0		
11	15	1PE22-7 . L0	FSC	6SL3203-0CE23-8AA0
15	20	1PE23-3 . L0		

#### Technical specifications

Line voltage 200 ... 240 V 3 AC <sup>1)</sup> or 380 ... 480 V 3 AC		Line reactor			
		6SL3203-0CE13-2AA0	6SL3203-0CE21-0AA0	6SL3203-0CE21-8AA0	6SL3203-0CE23-8AA0
<b>Rated current</b>	A	4	11.3	22.3	47
<b>Power loss</b> at 50/60 Hz	W	23/26	36/40	53/59	88/97
<b>Line supply/load connection</b> 1L1, 1L2, 1L3 2L1, 2L2, 2L3		Screw terminals	Screw terminals	Screw terminals	Screw terminals
• Conductor cross-section	mm <sup>2</sup>	4	4	10	16
<b>PE connection</b>		M4 × 8; U washer; spring lock washer	M4 × 8; U washer; spring lock washer	M5 × 10; U washer; spring lock washer	M5 × 10; U washer; spring lock washer
<b>Degree of protection</b>		IP20	IP20	IP20	IP20
<b>Dimensions</b>					
• Width	mm (in)	125 (4.92)	125 (4.92)	125 (4.92)	190 (7.48)
• Height	mm (in)	120 (4.72)	140 (5.51)	145 (5.71)	220 (8.66)
• Depth	mm (in)	71 (2.80)	71 (2.80)	91 (3.58)	91 (3.58)
<b>Weight, approx.</b>	kg (lb)	1.1 (2.43)	2.1 (4.63)	2.95 (6.50)	7.8 (17.2)
<b>Suitable for PM240-2 Power Module standard variant 200 ... 240 V 3 AC</b>	Type	6SL3210-1PB13-0 . L0 6SL3210-1PB13-8 . L0	6SL3210-1PB15-5 . L0 6SL3210-1PB17-4 . L0 6SL3210-1PB21-0 . L0	6SL3210-1PB21-4 . L0 6SL3210-1PB21-8 . L0	–
• Frame size		FSA	FSB	FSC	–
<b>Suitable for PM240-2 Power Module standard variant 380 ... 480 V 3 AC</b>	Type	6SL3210-1PE11-8 . L1 6SL3210-1PE12-3 . L1 6SL3210-1PE13-2 . L1	6SL3210-1PE14-3 . L1 6SL3210-1PE16-1 . L1 6SL3210-1PE18-0 . L1	6SL3210-1PE21-1 . L0 6SL3210-1PE21-4 . L0 6SL3210-1PE21-8 . L0	6SL3210-1PE22-7 . L0 6SL3210-1PE23-3 . L0
• Frame size		FSA	FSA	FSB	FSC

<sup>1)</sup> With the appropriate wiring, the line reactors for 200 V 3 AC can be used for the 200 V versions for 200 V 1 AC. More information can be found on the internet at:  
<https://support.industry.siemens.com/cs/document/109486005>  
<https://support.industry.siemens.com/cs/document/109482011>

**SINAMICS S110 servo drives**

0.55 kW to 132 kW (0.75 hp to 150 hp)

**Line-side components > Recommended line-side overcurrent protection devices****Selection and ordering data**

Overcurrent protection devices are absolutely necessary for the operation of the converters. The following tables list recommendations for fuses.

- Siemens fuses of type 3NA3 for use in the area of validity of IEC
- UL-listed fuses Class J for use in USA and Canada

Recommendations on further overcurrent protection devices are available at:

<https://support.industry.siemens.com/cs/document/109486009>

The Short Circuit Current Rating (SCCR) according to UL for industrial control panel installations to NEC Article 409 or UL 508A/508C or UL 61800-5-1 is as follows for Class J fuses for

- PM240-2 Power Modules for SINAMICS G120: 100 kA

SCCR and ICC values for combination with further overcurrent protection devices are available at:

<https://support.industry.siemens.com/cs/document/109486009>

Notes for installations in Canada:

The converters are intended for line supply systems with overvoltage category III. More information is available in the technical documentation on the internet at:

[www.siemens.com/sinamics-s110/documentation](http://www.siemens.com/sinamics-s110/documentation)

More information about the listed Siemens fuses is available in Catalog LV 10 as well as in the Industry Mall.

Type rating <sup>1)</sup>		PM240-2 Power Module standard variant		IEC-compliant Fuse		UL/cUL-compliant Fuse type Rated voltage 600 V AC	
kW	hp	Type 6SL3210-...	Frame size	Current A	Article No.	Class	Current A
<b>200 ... 240 V 1 AC/3 AC</b>							
0.55	0.75	1PB13-0 . L0	FSA	16	<b>3NA3805</b>	J	15
0.75	1	1PB13-8 . L0	FSA	16	<b>3NA3805</b>	J	15
1.1	1.5	1PB15-5 . L0	FSB	32	<b>3NA3812</b>	J	35
1.5	2	1PB17-4 . L0	FSB	32	<b>3NA3812</b>	J	35
2.2	3	1PB21-0 . L0	FSB	32	<b>3NA3812</b>	J	35
3	4	1PB21-4 . L0	FSC	50	<b>3NA3820</b>	J	50
4	5	1PB21-8 . L0	FSC	50	<b>3NA3820</b>	J	50
<b>380 ... 480 V 3 AC</b>							
0.55	0.75	1PE11-8 . L1	FSA	10	<b>3NA3803</b>	J	10
0.75	1	1PE12-3 . L1	FSA	10	<b>3NA3803</b>	J	10
1.1	1.5	1PE13-2 . L1	FSA	16	<b>3NA3805</b>	J	15
1.5	2	1PE14-3 . L1	FSA	16	<b>3NA3805</b>	J	15
2.2	3	1PE16-1 . L1	FSA	16	<b>3NA3805</b>	J	15
3	4	1PE18-0 . L1	FSA	16	<b>3NA3805</b>	J	15
4	5	1PE21-1 . L0	FSB	32	<b>3NA3812</b>	J	35
5.5	7.5	1PE21-4 . L0	FSB	32	<b>3NA3812</b>	J	35
7.5	10	1PE21-8 . L0	FSB	32	<b>3NA3812</b>	J	35
11	15	1PE22-7 . L0	FSC	50	<b>3NA3820</b>	J	50
15	20	1PE23-3 . L0	FSC	50	<b>3NA3820</b>	J	50
18.5	25	1PE23-8 . L0	FSD	63	<b>3NA3822</b>	J	60
22	30	1PE24-5 . L0	FSD	80	<b>3NA3824</b>	J	70
30	40	1PE26-0 . L0	FSD	100	<b>3NA3830</b>	J	90
37	50	1PE27-5 . L0	FSD	100	<b>3NA3830</b>	J	100
45	60	1PE28-8 . L0	FSE	125	<b>3NA3832</b>	J	125
55	75	1PE31-1 . L0	FSE	160	<b>3NA3836</b>	J	150
75	100	1PE31-5 . L0	FSF	200	<b>3NA3140</b>	J	200
90	125	1PE31-8 . L0	FSF	224	<b>3NA3142</b>	J	250
110	150	1PE32-1 . L0	FSF	300	<b>3NA3250</b>	J	300
132	200	1PE32-5 . L0	FSF	315	<b>3NA3252</b>	J	350

<sup>1)</sup> Type rating based on the rated output current  $I_N$ . The rated output current  $I_N$  is based on the duty cycle for low overload (LO).



## SINAMICS S110 servo drives

0.55 kW to 132 kW (0.75 hp to 150 hp)

### DC link components > Braking resistors

#### Overview



Braking resistor for PM240-2 Power Modules, frame size FSD

Excess energy in the DC link is dissipated in the braking resistor. The braking resistors are intended for use with PM240-2 Power Modules which feature an integrated braking chopper, but cannot regenerate energy to the supply system. For regenerative operation, e.g. the braking of a rotating mass with high moment of inertia, a braking resistor must be connected to convert the resulting energy into heat.

The braking resistors can be installed laterally next to the PM240-2 Power Modules. The braking resistors for the Power Modules, frame sizes FSD to FSF, should be placed outside the control cabinet or outside the switchgear room so that the heat is dissipated away from the Power Modules. The level of air conditioning required is therefore reduced.

Every braking resistor has a temperature switch (UL-listed). The temperature switch should be evaluated to prevent consequential damage if the braking resistor overheats.

#### Note:

Shield connection kits are available for EMC-compliant installation of Power Modules.

A shield connection kit is supplied as standard with PM240-2 Power Modules in frame sizes FSA to FSC.

A set of shield plates is included in the scope of delivery for the motor and signal cables corresponding to the frame size for the frame sizes FSD to FSF. For the electromagnetically compatible connection of an optionally connectable braking resistor, the corresponding shield connection kit is to be ordered for frame sizes FSD to FSF.

For more information, see shield connection kits for Power Modules in the section Supplementary system components.

#### Integration

##### **Braking resistors that are optionally available depending on the Power Module used**

	Frame size					
	FSA	FSB	FSC	FSD	FSE	FSF
<b>PM240-2 Power Module with integrated braking chopper</b>						
<b>DC link components</b>						
Braking resistor	S	S	S	S	S	S

S = Lateral mounting

**SINAMICS S110 servo drives**

0.55 kW to 132 kW (0.75 hp to 150 hp)

**DC link components > Braking resistors****Selection and ordering data**

Type rating		PM240-2 Power Module standard variant	Braking resistor (The prefix "JJY:" is part of a Siemens internal order code which does not belong to the product number of the original equipment manufacturer Heine Resistor GmbH)	
kW	hp	Type 6SL3210-...	Frame size	Article No.
<b>200 ... 240 V 1 AC/3 AC</b>				
0.55	0.75	1PB13-0 . L0	FSA	<b>JJY:023146720008</b>
0.75	1	1PB13-8 . L0		
1.1	1.5	1PB15-5 . L0	FSB	<b>JJY:023151720007</b>
1.5	2	1PB17-4 . L0		
2.2	3	1PB21-0 . L0		
3	4	1PB21-4 . L0	FSC	<b>JJY:023163720018</b>
4	5	1PB21-8 . L0		
<b>380 ... 480 V 3 AC</b>				
0.55	0.75	1PE11-8 . L1	FSA	<b>6SL3201-0BE14-3AA0</b>
0.75	1	1PE12-3 . L1		
1.1	1.5	1PE13-2 . L1		
1.5	2	1PE14-3 . L1		
2.2	3	1PE16-1 . L1	FSA	<b>6SL3201-0BE21-0AA0</b>
3	4	1PE18-0 . L1		
4	5	1PE21-1 . L0	FSB	<b>6SL3201-0BE21-8AA0</b>
5.5	7.5	1PE21-4 . L0		
7.5	10	1PE21-8 . L0		
11	15	1PE22-7 . L0	FSC	<b>6SL3201-0BE23-8AA0</b>
15	20	1PE23-3 . L0		
18.5	25	1PE23-8 . L0	FSD	<b>JJY:023422620001</b>
22	30	1PE24-5 . L0		
30	40	1PE26-0 . L0	FSD	<b>JJY:023424020001</b>
37	50	1PE27-5 . L0		
45	60	1PE28-8 . L0	FSE	<b>JJY:023434020001</b>
55	75	1PE31-1 . L0		
75	100	1PE31-5 . L0	FSF	<b>JJY:023454020001</b>
90	125	1PE31-8 . L0		
110	150	1PE32-1 . L0	FSF	<b>JJY:023464020001</b>
132	200	1PE32-5 . L0		

## SINAMICS S110 servo drives

0.55 kW to 132 kW (0.75 hp to 150 hp)

### DC link components > Braking resistors

#### Technical specifications

Line voltage 200 V ... 240 V 1 AC/3 AC		Braking resistor		
		JJY:023146720008	JJY:023151720007	JJY:023163720018
<b>Resistance</b>	Ω	200	68	37
<b>Rated power <math>P_{DB}</math></b> (Continuous braking power)	kW	0.0375	0.11	0.2
<b>Peak power <math>P_{max}</math></b> (load duration $t_a = 12$ s with period $t = 240$ s)	kW	0.75	2.2	4
<b>Power connection</b>		Cable	Cable	Cable
<b>Thermostatic switch</b>		Integrated	Integrated	Integrated
<b>Degree of protection</b>		IP20	IP20	IP20
<b>Dimensions</b>				
• Width	mm (in)	60 (2.36)	60 (2.36)	60 (2.36)
• Height	mm (in)	167 (6.57)	217 (8.54)	337 (13.27)
• Depth	mm (in)	30 (1.18)	30 (1.18)	30 (1.18)
<b>Weight, approx.</b>	kg (lb)	0.5 (1.10)	0.7 (1.54)	1.1 (2.43)
<b>Suitable for PM240-2 Power Module standard variant</b>	Type	6SL3210-1PB13-0 . L0 6SL3210-1PB13-8 . L0	6SL3210-1PB15-5 . L0 6SL3210-1PB17-4 . L0 6SL3210-1PB21-0 . L0	6SL3210-1PB21-4 . L0 6SL3210-1PB21-8 . L0
• Frame size		FSA	FSB	FSC

Line voltage 380 ... 480 V 3 AC		Braking resistor			
		6SL3201-0BE14-3AA0	6SL3201-0BE21-0AA0	6SL3201-0BE21-8AA0	6SL3201-0BE23-8AA0
<b>Resistance</b>	Ω	370	140	75	30
<b>Rated power <math>P_{DB}</math></b> (Continuous braking power)	kW	0.075	0.2	0.375	0.925
<b>Peak power <math>P_{max}</math></b> (load duration $t_a = 12$ s with period $t = 240$ s)	kW	1.5	4	7.5	18.5
<b>Power connection</b>		Terminal block	Terminal block	Terminal block	Terminal block
• Conductor cross-section	mm <sup>2</sup>	2.5	2.5	4	6
<b>Thermostatic switch</b>		NC contact	NC contact	NC contact	NC contact
• Contact load, max.		250 V AC/2.5 A	250 V AC/2.5 A	250 V AC/2.5 A	250 V AC/2.5 A
• Conductor cross-section	mm <sup>2</sup>	2.5	2.5	2.5	2.5
<b>PE connection</b>					
• Via terminal block		Yes	Yes	Yes	Yes
• PE connection on housing		M4 screw	M4 screw	M4 screw	M4 screw
<b>Degree of protection</b>		IP20	IP20	IP20	IP20
<b>Dimensions</b>					
• Width	mm (in)	105 (4.13)	105 (4.13)	175 (6.89)	250 (9.84)
• Height	mm (in)	295 (11.61)	345 (13.58)	345 (13.58)	490 (19.29)
• Depth	mm (in)	100 (3.94)	100 (3.94)	100 (3.94)	140 (5.51)
<b>Weight, approx.</b>	kg (lb)	1.5 (3.31)	1.8 (3.97)	2.7 (5.95)	6.2 (13.7)
<b>Suitable for PM240-2 Power Modules standard variant</b>	Type	6SL3210-1PE11-8 . L1 6SL3210-1PE12-3 . L1 6SL3210-1PE13-2 . L1 6SL3210-1PE14-3 . L1	6SL3210-1PE16-1 . L1 6SL3210-1PE18-0 . L1	6SL3210-1PE21-1 . L0 6SL3210-1PE21-4 . L0 6SL3210-1PE21-8 . L0	6SL3210-1PE22-7 . L0 6SL3210-1PE23-3 . L0
• Frame size		FSA	FSA	FSB	FSC

## SINAMICS S110 servo drives

0.55 kW to 132 kW (0.75 hp to 150 hp)

### DC link components > Braking resistors

#### Technical specifications

Line voltage 380 ... 480 V 3 AC		Braking resistor				
		JJY:023422620001	JJY:023424020001	JJY:023434020001	JJY:023454020001 <sup>1)</sup>	JJY:023464020001 <sup>2)</sup>
<b>Resistance</b>	Ω	25	15	10	7.1	5
<b>Rated power <math>P_{DB}</math></b> (Continuous braking power)	kW	1.1	1.85	2.75	3.85	5.5
<b>Peak power <math>P_{max}</math></b> (load duration $t_a = 12$ s with period $t = 240$ s)	kW	22	37	55	77	110
<b>Power connection</b>		Cable	Cable	Cable	Cable	Cable
<b>Thermostatic switch</b>		Integrated	Integrated	Integrated	Integrated	Integrated
<b>Degree of protection</b>		IP21	IP21	IP21	IP21	IP21
<b>Dimensions</b>						
• Width	mm (in)	220 (8.66)	220 (8.66)	350 (13.78)	1)	2)
• Height	mm (in)	470 (18.5)	610 (24.02)	630 (24.8)	1)	2)
• Depth	mm (in)	180 (7.09)	180 (7.09)	180 (7.09)	1)	2)
<b>Weight, approx.</b>	kg (lb)	7 (15.4)	9.5 (20.9)	13.5 (29.8)	20.5 (45.2)	27 (59.5)
<b>Suitable for PM240-2 Power Module</b>	Type	6SL3210-1PE23-8 . LO 6SL3210-1PE24-5 . LO	6SL3210-1PE26-0 . LO 6SL3210-1PE27-5 . LO	6SL3210-1PE28-8 . LO 6SL3210-1PE31-1 . LO	6SL3210-1PE31-5 . LO 6SL3210-1PE31-8 . LO	6SL3210-1PE32-1 . LO 6SL3210-1PE32-5 . LO
• Frame size		FSD	FSD	FSE	FSF	FSF

#### Characteristic curves

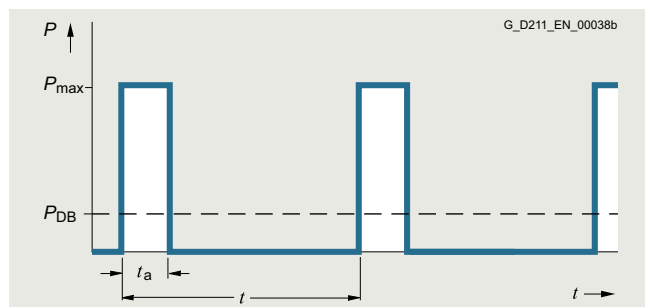

Load diagram for the braking resistors

$t_a = 12$  s (see section Technical specifications)  
 $t = 240$  s (see section Technical specifications)

<sup>1)</sup> This braking resistor consists of the two braking resistors, JJY:023422620001 and JJY:023434020001, which must be connected in parallel on the plant/system side.

<sup>2)</sup> This braking resistor consists of two JJY:023434020001 braking resistors, which must be connected in parallel on the plant/system side.

## SINAMICS S110 servo drives

0.55 kW to 132 kW (0.75 hp to 150 hp)

### Load-side power components > Output reactors

#### Overview

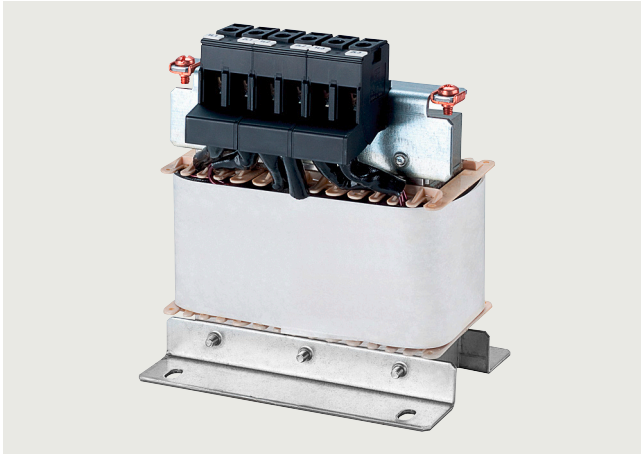

Output reactor for PM240-2 Power Modules, frame size FSA

Output reactors reduce the rate of voltage rise ( $dv/dt$ ) and the height of the current peaks, and enable longer motor cables to be connected.

Owing to the high rates of voltage rise of the fast-switching IGBTs, the capacitance of long motor cables reverses polarity very quickly with every switching operation in the inverter. As a result, the inverter is loaded with additional current peaks of substantial magnitude.

Output reactors reduce the magnitude of these additional peaks because the cable capacitance reverses polarity more slowly across the reactor inductance, thereby attenuating the amplitudes of the current peaks.

When using output reactors, the following should be observed:

- Max. permissible output frequency 150 Hz
- Max. permissible pulse frequency 4 kHz
- The output reactor must be installed as close as possible to the Power Module

#### Integration

**Output reactors that are optionally available depending on the Power Module used**

	Frame size					
	FSA	FSB	FSC	FSD	FSE	FSF
<b>PM240-2 Power Module with integrated braking chopper</b>						
<b>Load-side power components</b>						
Output reactor	S	S	S	S	S	S

S = Lateral mounting

**SINAMICS S110 servo drives**

0.55 kW to 132 kW (0.75 hp to 150 hp)

**Load-side power components > Output reactors****Selection and ordering data**

Type rating		PM240-2 Power Module		Output reactor
kW	hp	standard variant	Frame size	Article No.
		Type 6SL3210-...		
<b>200 ... 240 V 1 AC/3 AC</b>				
0.55	0.75	1PB13-0 . L0	FSA	<b>6SL3202-0AE16-1CA0</b>
0.75	1	1PB13-8 . L0		
1.1	1.5	1PB15-5 . L0	FSB	<b>6SL3202-0AE16-1CA0</b>
1.5	2	1PB17-4 . L0	FSB	<b>6SL3202-0AE18-8CA0</b>
2.2	3	1PB21-0 . L0	FSB	<b>6SL3202-0AE21-8CA0</b>
3	4	1PB21-4 . L0	FSC	<b>6SL3202-0AE21-8CA0</b>
4	5	1PB21-8 . L0		
<b>380 ... 480 V 3 AC</b>				
0.55	0.75	1PE11-8 . L1	FSA	<b>6SL3202-0AE16-1CA0</b>
0.75	1	1PE12-3 . L1		
1.1	1.5	1PE13-2 . L1		
1.5	2	1PE14-3 . L1		
2.2	3	1PE16-1 . L1		
3	4	1PE18-0 . L1	FSA	<b>6SL3202-0AE18-8CA0</b>
4	5	1PE21-1 . L0	FSB	<b>6SL3202-0AE21-8CA0</b>
5.5	7.5	1PE21-4 . L0		
7.5	10	1PE21-8 . L0		
11	15	1PE22-7 . L0	FSC	<b>6SL3202-0AE23-8CA0</b>
15	20	1PE23-3 . L0		
18.5	25	1PE23-8 . L0	FSD	<b>6SE6400-3TC07-5ED0</b>
22	30	1PE24-5 . L0		
30	40	1PE26-0 . L0		
37	50	1PE27-5 . L0		
45	60	1PE28-8 . L0	FSE	<b>6SE6400-3TC14-5FD0</b>
55	75	1PE31-1 . L0		
75	100	1PE31-5 . L0	FSF	<b>6SE6400-3TC14-5FD0</b>
90	125	1PE31-8 . L0		
110	150	1PE32-1 . L0	FSF	<b>6SL3000-2BE32-1AA0</b>
132	200	1PE32-5 . L0	FSF	<b>6SL3000-2BE32-6AA0</b>

## SINAMICS S110 servo drives

0.55 kW to 132 kW (0.75 hp to 150 hp)

### Load-side power components > Output reactors

#### Technical specifications

Line voltage 200 ... 240 V 1 AC/3 AC or 380 ... 480 V 3 AC		Output reactor (for a 4 kHz pulse frequency)			
		6SL3202-0AE16-1CA0	6SL3202-0AE18-8CA0	6SL3202-0AE21-8CA0	6SL3202-0AE23-8CA0
<b>Rated current</b>	A	6.1	9	18.5	39
<b>Power loss, max.</b>	kW	0.09	0.08	0.08	0.11
<b>Connection to the Power Module/ motor connection</b>		Screw terminals	Screw terminals	Screw terminals	Screw terminals
• Conductor cross-section	mm <sup>2</sup>	4	4	10	16
<b>PE connection</b>		M4 screw stud	M4 screw stud	M5 screw stud	M5 screw stud
<b>Cable length, max.</b> between output reactor and motor					
• 200 -10 % ... 240 V +10 % 3 AC and 380 -10 % ... 415 V +10 % 3 AC					
- Shielded	m (ft)	150 (492)	150 (492)	150 (492)	150 (492)
- Unshielded	m (ft)	225 (738)	225 (738)	225 (738)	225 (738)
• 440 ... 480 V 3 AC +10 %					
- Shielded	m (ft)	100 (328)	100 (328)	100 (328)	100 (328)
- Unshielded	m (ft)	150 (492)	150 (492)	150 (492)	150 (492)
<b>Dimensions</b>					
• Width	mm (in)	207 (8.15)	207 (8.15)	247 (9.72)	257 (10.1)
• Height	mm (in)	175 (6.89)	180 (7.09)	215 (8.46)	235 (9.25)
• Depth	mm (in)	72.5 (2.85)	72.5 (2.85)	100 (3.94)	114.7 (4.52)
<b>Degree of protection</b>		IP20	IP20	IP20	IP20
<b>Weight, approx.</b>	kg (lb)	3.4 (7.5)	3.9 (8.6)	10.1 (22.3)	11.2 (24.7)
<b>Suitable for PM240-2 standard variant 200 ... 240 V 1 AC/3 AC</b>	Type	6SL3210-1PB13-0 . L0 6SL3210-1PB13-8 . L0 FSA  6SL3210-1PB15-5 . L0 FSB	6SL3210-1PB17-4 . L0 FSB	6SL3210-1PB21-0 . L0 6SL3210-1PB21-4 . L0 FSB  6SL3210-1PB21-8 . L0 FSC	–
<b>Suitable for PM240-2 standard variant 380 ... 480 V 3 AC</b>	Type	6SL3210-1PE11-8 . L1 6SL3210-1PE12-3 . L1 6SL3210-1PE13-2 . L1 6SL3210-1PE14-3 . L1 6SL3210-1PE16-1 . L1 FSA	6SL3210-1PE18-0 . L1 FSA	6SL3210-1PE21-1 . L0 6SL3210-1PE21-4 . L0 6SL3210-1PE21-8 . L0 FSB	6SL3210-1PE22-7 . L0 6SL3210-1PE23-3 . L0 FSC

## SINAMICS S110 servo drives

0.55 kW to 132 kW (0.75 hp to 150 hp)

### Load-side power components > Output reactors

#### Technical specifications

Line voltage 380 ... 480 V 3 AC		Output reactor (for a 4 kHz pulse frequency)			
		6SE6400-3TC07-5ED0	6SE6400-3TC14-5FD0	6SL3000-2BE32-1AA0	6SL3000-2BE32-6AA0
<b>Rated current</b>	A	90	178	210	260
<b>Power loss, max.</b>	kW	0.27	0.47	0.49	0.5
<b>Connection to the Power Module/ motor connection</b>		Flat connector for M6 screw	Flat connector for M8 screw	Flat connector for M10 screw	Flat connector for M10 screw
<b>PE connection</b>		M6 screw	M8 screw	M8 screw	M8 screw
<b>Cable length, max.</b> between output reactor and motor					
• Shielded	m (ft)	200 (656)	200 (656)	300 (984)	300 (984)
• Unshielded	m (ft)	300 (984)	300 (984)	450 (1476)	450 (1476)
<b>Dimensions</b>					
• Width	mm (in)	270 (10.63)	350 (13.78)	300 (11.81)	300 (11.81)
• Height	mm (in)	248 (9.76)	321 (12.64)	285 (11.22)	315 (12.4)
• Depth	mm (in)	209 (8.23)	288 (11.34)	257 (10.12)	277 (10.91)
<b>Degree of protection</b>		IP00	IP00	IP00	IP00
<b>Weight, approx.</b>	kg (lb)	27 (59.5)	57 (126)	60 (132)	66 (146)
<b>Suitable for PM240-2 standard variant</b>	Type	6SL3210-1PE23-8 . L0 6SL3210-1PE24-5 . L0 6SL3210-1PE26-0 . L0 6SL3210-1PE27-5 . L0 FSD	6SL3210-1PE28-8 . L0 6SL3210-1PE31-1 . L0 FSE  6SL3210-1PE31-5 . L0 6SL3210-1PE31-8 . L0 FSF	6SL3210-1PE32-1 . L0 FSF	6SL3210-1PE32-5 . L0 FSF



## SINAMICS S110 servo drives

0.55 kW to 132 kW (0.75 hp to 150 hp)

### Supplementary system components > Shield connection kits for Power Modules

#### Overview

Shield connection kits are available for EMC-compliant installation of Power Modules. The shield connection kit makes it easier to connect the shields of supply and control cables, provides mechanical strain relief and thus ensures optimum EMC performance.

A shield connection kit is supplied as standard with PM240-2 Power Modules in frame sizes FSA to FSC. A set of shield plates is included in the scope of delivery for the motor and signal cables corresponding to the frame size for the frame sizes FSD to FSF. For the electromagnetically compatible connection of an optionally connectable braking resistor, the corresponding shield connection kit is to be ordered for frame sizes FSD to FSF.

#### Selection and ordering data

Description	Article No.
<b>Shield connection kit</b> for PM240-2 Power Modules	Supplied with the Power Modules, available as a spare part
<ul style="list-style-type: none"> <li>• Frame sizes FSA to FSC</li> </ul>	
<ul style="list-style-type: none"> <li>• Frame sizes FSD to FSF                A set of shield plates is included in the scope of delivery for the motor and signal cables corresponding to the frame size. For the electromagnetically compatible connection of an optionally connectable braking resistor, the corresponding shield connection kit is to be ordered.</li> </ul>	
- Frame size FSD	<b>6SL3262-1AD01-0DA0</b>
- Frame size FSE	<b>6SL3262-1AE01-0DA0</b>
- Frame size FSF	<b>6SL3262-1AF01-0DA0</b>

## SINAMICS S110 servo drives

0.55 kW to 132 kW (0.75 hp to 150 hp)

### Supplementary system components > BOP20 Basic Operator Panel

#### Overview



BOP20 Basic Operator Panel

Parameters can be set, diagnostics information (e.g. alarm and fault messages) read out and faults acknowledged using the BOP20 Basic Operator Panel.

#### Design

The BOP20 Basic Operator Panel has a backlit two-line display area with six keys.

The integrated plug connector on the rear of the BOP20 Basic Operator Panel provides its power and establishes communication with the Control Unit.

#### Selection and ordering data

Description	Article No.
<b>BOP20 Basic Operator Panel</b>	<b>6SL3055-0AA00-4BA0</b>

#### Integration

The BOP20 Basic Operator Panel can be inserted on the following Control Units:

- SINAMICS S110
  - CU305
- SINAMICS S120
  - CU310-2
  - CU320-2



Control Unit CU305 with attached BOP20 Basic Operator Panel

### Overview



Safe Brake Relay

With the Safe Brake Relay, the brake is controlled in accordance with IEC 61508 SIL 2 and EN ISO 13849-1 PL d and Category 3.

### Design

The Safe Brake Relay can be installed below the Power Module on the shield connection plate.

The Safe Brake Relay has the following connections and interfaces:

- 1 two-channel transistor output stage to control the motor brake solenoid
- 1 connection for the cable harness (CTRL) to the Power Module in blocksize format
- 1 connection for the 24 V DC power supply

The connection between the 24 V DC supply and the Safe Brake Relay must be kept as short as possible.

The scope of supply of a Safe Brake Relay includes the following:

- 3 cable harnesses for connecting to the CTRL socket of the Power Module
  - Length 0.32 m (1.05 ft) for frame sizes FSA to FSC
  - Length 0.55 m (1.80 ft) for frame sizes FSD and FSE
  - Length 0.8 m (2.62 ft) for frame size FSF
  - Length 1.1 m (3.61 ft) for frame size FSG

### Selection and ordering data

Description	Article No.
<b>Safe Brake Relay</b> Including cable harness for connection to Power Module	<b>6SL3252-0BB01-0AA0</b>

### Technical specifications

Safe Brake Relay	
6SL3252-0BB01-0AA0	
<b>Power supply</b>	20.4 ... 28.8 V DC Recommended rated supply voltage 26 V DC (to compensate for voltage drop in feeder cable to 24 V DC motor brake solenoid)
<b>Current requirement, max.</b>	<ul style="list-style-type: none"> <li>• Motor brake: 2.5 A</li> <li>• At 24 V DC: 0.05 A + the current requirement of motor brake</li> </ul>
<b>Conductor cross-section, max.</b>	2.5 mm <sup>2</sup>
<b>Dimensions</b>	<ul style="list-style-type: none"> <li>• Width: 69 mm (2.72 in)</li> <li>• Height: 63 mm (2.48 in)</li> <li>• Depth: 33 mm (1.30 in)</li> </ul>
<b>Weight, approx.</b>	0.17 kg (0.37 lb)

### Integration

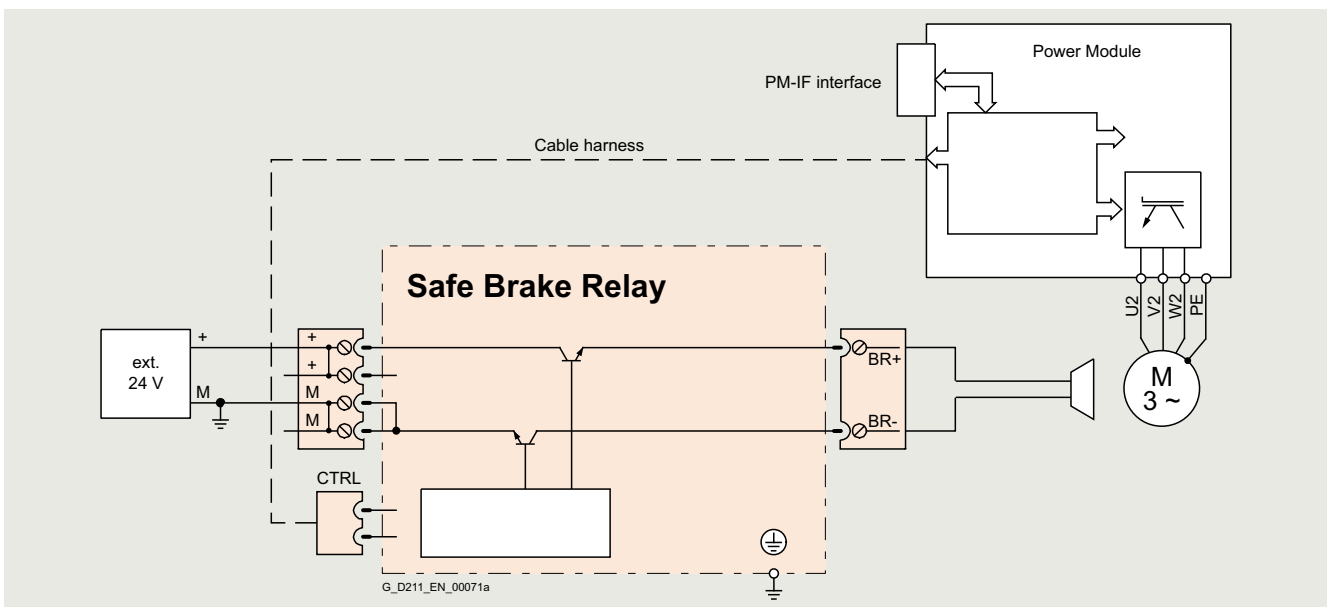

Connection example of a Safe Brake Relay

The 24 V DC solenoid of the motor brake is directly connected to the Safe Brake Relay. External overvoltage limiters are not required.

## SINAMICS S110 servo drives

0.55 kW to 132 kW (0.75 hp to 150 hp)

### Encoder system connection

#### Overview

##### Motors with DRIVE-CLiQ interface

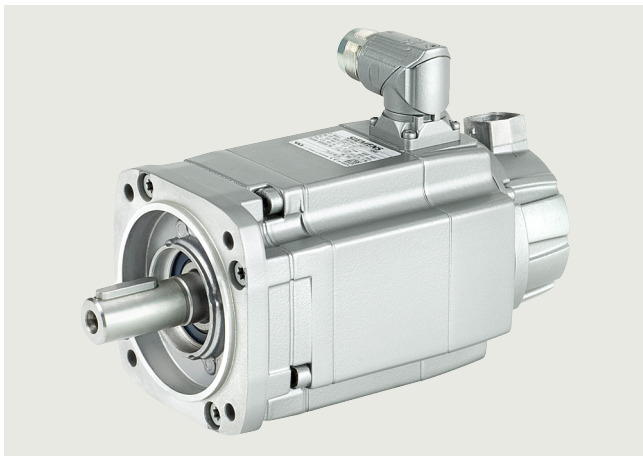

DRIVE-CLiQ is the preferred method for connecting the encoder systems to SINAMICS S110 or SINAMICS S120.

Motors with DRIVE-CLiQ interface are available for this purpose, e.g.

- SIMOTICS M-1PH8 and SIMOTICS S-1FT7/1FK7 synchronous motors
- SIMOTICS M-1PH8 asynchronous motors (induction motors)
- SIMOTICS T-1FW3 torque motors

Motors with a DRIVE-CLiQ interface can be directly connected to the SINAMICS S110 Control Unit CU305 or, in case of the SINAMICS S120 drive system, to the associated Motor Module using MOTION-CONNECT DRIVE-CLiQ cables. The MOTION-CONNECT DRIVE-CLiQ cable connection at the motor has degree of protection IP67.

The DRIVE-CLiQ interface supplies the motor encoder via the integrated 24 V DC supply and transfers the motor encoder and temperature signals and the electronic rating plate data, e.g. a unique identification number and rated data (voltage, current, torque) to the Control Unit. This means that for the various encoder types – e.g. resolver or absolute encoder – different encoder cables with varying permissible lengths are no longer required; just one cable type, MOTION-CONNECT DRIVE-CLiQ with varying permissible lengths, can be used for all encoders.

These motors simplify commissioning and diagnostics, as the motor and encoder type are identified automatically.

##### Motors without DRIVE-CLiQ interface

The encoder and temperature signals of motors without DRIVE-CLiQ interface, as well as those of external encoders, must be connected via Sensor Modules. Sensor Modules Cabinet-Mounted are available in degree of protection IP20 for control cabinet installation, as well as Sensor Modules External-Mounted in degree of protection IP67.

Only one encoder system can be connected to each Sensor Module.

#### More information

Motor encoder and temperature signals must be connected when possible to the corresponding Motor Module or Power Module and external encoders to the Control Unit. However, the DRIVE-CLiQ connections can also be bundled via DRIVE-CLiQ Hub Modules.

##### Safety Integrated

The Safety Integrated extended functions of the SINAMICS drive system require suitable encoders (see [Catalog D 21.4, SIMOTICS servomotors section](#)).

##### Motors driving a load via a belt

Unfavorable material combinations generate static electricity between the belt pulley and the belt. Electrostatic charging must be prevented, since this can discharge via the motor shaft and the encoder, thereby causing disturbances in the encoder signals. One countermeasure is to manufacture belts out of an antistatic material, for example.

# SINAMICS S110 servo drives

0.55 kW to 132 kW (0.75 hp to 150 hp)

## Encoder system connection > SMC10 Sensor Module Cabinet-Mounted

### Overview



SMC10 Sensor Module Cabinet-Mounted

The SMC10 Sensor Module Cabinet-Mounted is required to evaluate the encoder signals of motors without a DRIVE-CLiQ interface. External encoders can also be connected via the SMC10.

The following encoder signals can be evaluated:

- 2-pole resolver
- Multi-pole resolver

### Design

The SMC10 Sensor Module Cabinet-Mounted features the following connections and interfaces as standard:

- 1 encoder connection including motor temperature sensing (KTY84-130, Pt1000<sup>1)</sup> or PTC) via SUB-D connector
- 1 DRIVE-CLiQ interface
- 1 connection for the electronics power supply via the 24 V DC supply connector
- 1 PE connection

The status of the SMC10 Sensor Module Cabinet-Mounted is indicated via a multi-color LED.

The SMC10 Sensor Module Cabinet-Mounted can be snapped onto a TH 35 standard mounting rail according to EN 60715 (IEC 60715).

The signal cable shield is connected via the encoder system connector and can also be connected to the SMC10 Sensor Module Cabinet-Mounted via a shield connection terminal, e.g. Phoenix Contact type SK8 or Weidmüller type KLBÜ CO 1. The shield connection terminal must not be used as a strain relief mechanism.

### Integration

SMC10 Sensor Modules Cabinet-Mounted communicate with a Control Unit via DRIVE-CLiQ.

### Selection and ordering data

Description	Article No.
<b>SMC10 Sensor Module Cabinet-Mounted</b> Without DRIVE-CLiQ cable	<b>6SL3055-0AA00-5AA3</b>
<b>Accessories for re-ordering</b>	
<b>Dust protection blanking plugs</b> (50 units) For DRIVE-CLiQ port	<b>6SL3066-4CA00-0AA0</b>

### Technical specifications

	<b>SMC10 Sensor Module Cabinet-Mounted</b> 6SL3055-0AA00-5AA3
<b>Current requirement, max.</b> at 24 V DC, without taking encoder into account	0.2 A
• Conductor cross-section, max.	2.5 mm <sup>2</sup>
• Fuse protection, max.	20 A
<b>Power loss, max.</b>	10 W
<b>Encoders which can be evaluated</b>	<ul style="list-style-type: none"> <li>• 2-pole resolvers</li> <li>• Multi-pole resolver</li> </ul>
• Excitation voltage, rms	4.1 V
• Excitation frequency	5 ... 16 kHz depending on the current controller clock cycle of the Motor Module or Power Module
• Transformation ratio	0.5
• Encoder frequency, max.	2 kHz (120000 rpm) depending on the number of resolver pole pairs and current controller clock cycle of the Motor Module or Power Module
• Signal subdivision (interpolation), max.	16384 times (14 bits)
• Cable length to encoder, max.	130 m (427 ft)
<b>PE connection</b>	M4 screw
<b>Dimensions</b>	
• Width	30 mm (1.18 in)
• Height	150 mm (5.91 in)
• Depth	111 mm (4.37 in)
<b>Weight, approx.</b>	0.45 kg (0.99 lb)
<b>Certificate of suitability</b>	cULus

<sup>1)</sup> The Pt1000 sensor is not supported when combined with a Control Unit CU305.

## SINAMICS S110 servo drives

0.55 kW to 132 kW (0.75 hp to 150 hp)

### Encoder system connection > SMC20 Sensor Module Cabinet-Mounted

#### Overview



SMC20 Sensor Module Cabinet-Mounted

The SMC20 Sensor Module Cabinet-Mounted is required to evaluate the encoder signals of motors without a DRIVE-CLiQ interface. External encoders can also be connected via the SMC20.

The following encoder signals can be evaluated:

- Incremental encoder sin/cos 1 V<sub>pp</sub>
- Absolute encoder EnDat 2.1
- SSI encoder with incremental signals sin/cos 1 V<sub>pp</sub> (firmware version 2.4 and later)

The motor temperature can also be sensed using a PTC thermistor KTY84-130, Pt1000<sup>1)</sup> or PTC.

#### Design

The SMC20 Sensor Module Cabinet-Mounted features the following connections and interfaces as standard:

- 1 encoder connection including motor temperature sensing (KTY84-130, Pt1000<sup>1)</sup> or PTC) via SUB-D connector
- 1 DRIVE-CLiQ interface
- 1 connection for the electronics power supply via the 24 V DC supply connector
- 1 PE connection

The status of the SMC20 Sensor Module Cabinet-Mounted is indicated via a multi-color LED.

The SMC20 Sensor Module Cabinet-Mounted can be snapped onto a TH 35 standard mounting rail according to EN 60715 (IEC 60715).

The signal cable shield is connected via the encoder system connector and can also be connected to the SMC20 Sensor Module Cabinet-Mounted via a shield connection terminal, e.g. Phoenix Contact type SK8 or Weidmüller type KLBÜ CO 1. The shield connection terminal must not be used as a strain relief mechanism.

#### Integration

SMC20 Sensor Modules Cabinet-Mounted communicate with a Control Unit via DRIVE-CLiQ.

#### Selection and ordering data

Description	Article No.
<b>SMC20 Sensor Module Cabinet-Mounted</b> Without DRIVE-CLiQ cable	<b>6SL3055-0AA00-5BA3</b>
<b>Accessories for re-ordering</b>	
<b>Dust protection blanking plugs</b> (50 units) For DRIVE-CLiQ port	<b>6SL3066-4CA00-0AA0</b>

#### Technical specifications

	<b>SMC20 Sensor Module Cabinet-Mounted</b> 6SL3055-0AA00-5BA3
<b>Current requirement, max.</b> at 24 V DC, without taking encoder into account	0.2 A
• Conductor cross-section, max.	2.5 mm <sup>2</sup>
• Fuse protection, max.	20 A
<b>Power loss, max.</b>	10 W
<b>Encoders which can be evaluated</b>	<ul style="list-style-type: none"> <li>• Incremental encoder sin/cos 1 V<sub>pp</sub></li> <li>• Absolute encoder EnDat 2.1</li> <li>• SSI encoder with incremental signals sin/cos 1 V<sub>pp</sub> (firmware version 2.4 and later)</li> </ul>
• Encoder supply	5 V DC/0.35 A
• Encoder frequency incremental signals, max.	500 kHz
• Signal subdivision (interpolation), max.	16384 times (14 bits)
• SSI baud rate	100 ... 1000 kBaud
• Cable length to encoder, max.	100 m (328 ft)
<b>PE connection</b>	M4 screw
<b>Dimensions</b>	
• Width	30 mm (1.18 in)
• Height	150 mm (5.91 in)
• Depth	111 mm (4.37 in)
<b>Weight, approx.</b>	0.45 kg (0.99 lb)
<b>Certificate of suitability</b>	cULus

<sup>1)</sup> The Pt1000 sensor is not supported when combined with a Control Unit CU305.

# SINAMICS S110 servo drives

0.55 kW to 132 kW (0.75 hp to 150 hp)

## Encoder system connection > SMC30 Sensor Module Cabinet-Mounted

### Overview

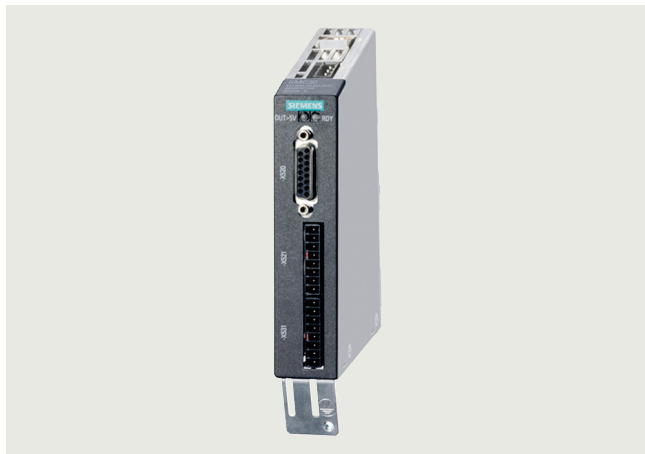

SMC30 Sensor Module Cabinet-Mounted

The SMC30 Sensor Module Cabinet-Mounted is required to evaluate the encoder signals of motors without a DRIVE-CLiQ interface. External encoders can also be connected via the SMC30.

The following encoder signals can be evaluated:

- Incremental encoders TTL/HTL with/without open-circuit detection (open-circuit detection is only available with bipolar signals)
- SSI encoder with TTL/HTL incremental signals
- SSI encoder without incremental signals

The motor temperature can also be sensed using a PTC thermistor KTY84-130, Pt1000<sup>1)</sup> or PTC.

### Design

The SMC30 Sensor Module Cabinet-Mounted features the following connections and interfaces as standard:

- 1 encoder connection including motor temperature sensing (KTY84-130, Pt1000<sup>1)</sup> or PTC) either via SUB-D connector or via terminals
- 1 DRIVE-CLiQ interface
- 1 connection for the electronics power supply via the 24 V DC supply connector
- 1 PE connection

The status of the SMC30 Sensor Module Cabinet-Mounted is indicated via a multi-color LED.

The SMC30 Sensor Module Cabinet-Mounted can be snapped onto a TH 35 standard mounting rail according to EN 60715 (IEC 60715).

The maximum encoder cable length between SMC30 modules and encoders is 100 m. For HTL encoders, this length can be increased to 300 m if the A+/A- and B+/B- signals are evaluated and the power supply cable has a minimum cross-section of 0.5 mm<sup>2</sup>.

The signal cable shield can be connected to the SMC30 Sensor Module Cabinet-Mounted via a shield connection terminal, e.g., Phoenix Contact type SK8 or Weidmüller type KLBÜ CO 1. The shield connection terminal must not be used as a strain relief mechanism.

### Integration

SMC30 Sensor Modules Cabinet-Mounted communicate with a Control Unit via DRIVE-CLiQ.

### Selection and ordering data

Description	Article No.
<b>SMC30 Sensor Module Cabinet-Mounted</b> Without DRIVE-CLiQ cable	<b>6SL3055-0AA00-5CA2</b>
<b>Accessories for re-ordering</b>	
<b>Dust protection blanking plugs</b> (50 units) For DRIVE-CLiQ port	<b>6SL3066-4CA00-0AA0</b>

### Technical specifications

<b>SMC30 Sensor Module Cabinet-Mounted</b> 6SL3055-0AA00-5CA2	
<b>Current requirement, max.</b> at 24 V DC, without taking encoder into account	0.2 A
• Conductor cross-section, max.	2.5 mm <sup>2</sup>
• Fuse protection, max.	20 A
<b>Power loss, max.</b>	10 W
<b>Encoders which can be evaluated</b>	<ul style="list-style-type: none"> <li>• Incremental encoder TTL/HTL</li> <li>• SSI encoder with TTL/HTL incremental signals</li> <li>• SSI encoder without incremental signals</li> </ul>
• Input current range TTL/HTL	4 ... 20 mA (typ. 10 mA)
• Encoder supply	24 V DC/0.35 A or 5 V DC/0.35 A
• Encoder frequency, max.	500 kHz
• SSI baud rate	100 ... 1000 kBaud
• Resolution absolute position SSI	30 bit
• Cable length, max.	
- TTL encoder	100 m (328 ft) (only bipolar signals permitted) <sup>2)</sup>
- HTL encoder	100 m (328 ft) for unipolar signals 300 m (984 ft) for bipolar signals <sup>2)</sup>
- SSI encoder	100 m (328 ft)
<b>PE connection</b>	M4 screw
<b>Dimensions</b>	
• Width	30 mm (1.18 in)
• Height	150 mm (5.91 in)
• Depth	111 mm (4.37 in)
<b>Weight, approx.</b>	0.45 kg (0.99 lb)
<b>Certificate of suitability</b>	cULus

<sup>1)</sup> The Pt1000 sensor is not supported when combined with a Control Unit CU305.

<sup>2)</sup> Signal cables twisted in pairs and shielded.

## SINAMICS S110 servo drives

### Notes

10



## SIMOTICS motors and SIMOGEAR geared motors

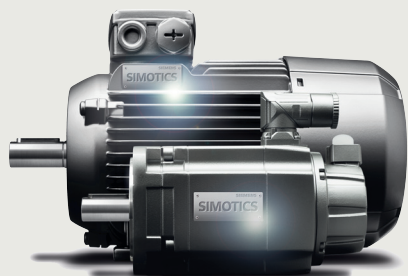

<b>11/2</b>	<b>Overview</b>
<b>11/8</b>	<b>SIMOTICS S-1FK7 servomotors for SINAMICS S110/SINAMICS S120</b>
11/8	SIMOTICS S-1FK7 Compact synchronous motors – Natural cooling
<b>11/16</b>	<b>SIMOTICS M-1PH8 main motors for SINAMICS S110/SINAMICS S120</b>
11/16	SIMOTICS M-1PH8 asynchronous motors – Forced ventilation
11/18	SIMOTICS M-1PH8 asynchronous motors – Water cooling
11/20	Article No. supplements
<b>11/22</b>	<b>Mechatronics components</b>
11/22	Electric cylinders

You can find more information on motors/geared motors on the internet at:  
[www.siemens.com/industrymall](http://www.siemens.com/industrymall)

**Siemens Product Configurator**

Product selection via selectors  
[www.siemens.com/spc](http://www.siemens.com/spc)

**SIZER for Siemens Drives (integrated into TIA Selection Tool)**

Engineering tool  
[www.siemens.com/sizer](http://www.siemens.com/sizer)

## SIMOTICS motors and SIMOGEAR geared motors

## Overview

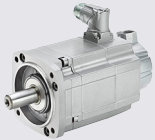
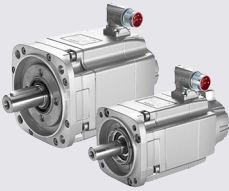
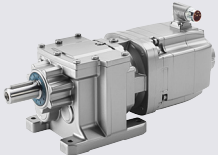
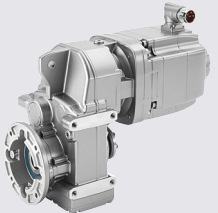
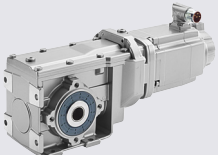
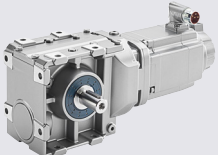
Motor type	Features	Degree of protection	Cooling method
<b>SIMOTICS S servomotors</b>			
 <b>SIMOTICS S-1FT7</b>	Compact Very high power density	IP64, IP65, IP67	Natural cooling
		IP64, IP65	Forced ventilation
	High Dynamic Very low rotor moment of inertia	IP64, IP65, IP67	Water cooling
		IP64, IP65	Forced ventilation
 <b>SIMOTICS S-1FK7</b>	Compact High power density	IP64, IP65	Natural cooling
	Compact for Power Modules 230 V 1 AC		
	High Dynamic Very low rotor moment of inertia	IP64, IP65	Natural cooling
	High Dynamic for Power Modules 230 V 1 AC		
	High Inertia High or variable load moment of inertia	IP64, IP65	Natural cooling
Motor type	Features	Degree of protection	Gearbox ratio (transmission stages)
<b>SIMOTICS S-1FG1 servo geared motors</b>			
 <b>Servo helical geared motors</b>	2-stage and 3-stage Solid shaft designs	IP65	<i>Z19 ... Z129</i> (2-stage)
			<i>D19 ... D129</i> (3-stage)
 <b>Servo parallel shaft geared motors</b>	2-stage and 3-stage Hollow shaft designs Solid shaft designs	IP65	<i>FZ29 ... FZ129</i> (2-stage)
			<i>FD29 ... FD129</i> (3-stage)
 <b>Servo bevel geared motors</b>	2-stage and 3-stage Hollow shaft designs Solid shaft designs	IP65	<i>B19 ... B49</i> (2-stage)
			<i>K39 ... K149</i> (3-stage)
 <b>Servo helical worm geared motors</b>	2-stage Hollow shaft designs Solid shaft design	IP65	<i>C29 ... C89</i> (2-stage)

## SIMOTICS motors and SIMOGEAR geared motors

Overview

Shaft height (SH)	Rated power $P_N$ for S1 duty kW (hp)							Rated torque $M_N$	Catalog
	0.01	0.1	1	10	100	1000	10000		
36, 48, 63, 80, 100, 132			0.88 (1.18) 16.96 (22.7)					1.4 ... 108 Nm (1.03 ... 79.7 lb <sub>f</sub> -ft)	D 21.4 NC 62
80, 100, 132			5 (6.71) 45.5 (61.0)				21 ... 250 Nm (15.5 ... 184 lb <sub>f</sub> -ft)		
63, 80, 100			3.1 (4.16) 34.2 (45.9)				9.2 ... 125 Nm (6.79 ... 92.2 lb <sub>f</sub> -ft)		
63, 80, 100			3.8 (5.10) 10.8 (14.5)				11 ... 33 Nm (8.11 ... 24.3 lb <sub>f</sub> -ft)		
63, 80			5.7 (7.64) 21.7 (29.1)				16.5 ... 51 Nm (12.2 ... 37.6 lb <sub>f</sub> -ft)		
20, 28, 36, 48, 63, 80, 100	0.05 (0.07)		8.2 (11.0)				0.08 ... 37 Nm (0.06 ... 27.3 lb <sub>f</sub> -ft)		
20, 28, 36, 48	0.05 (0.07)		0.8 (1.07)				0.08 ... 2.6 Nm (0.06 ... 1.92 lb <sub>f</sub> -ft)		
36, 48, 63, 80			0.6 (0.80) 7.5 (10.1)				0.9 ... 24 Nm (0.66 ... 17.7 lb <sub>f</sub> -ft)		
36, 48			0.4 (0.54) 0.9 (1.21)				1.2 ... 3 Nm (0.89 ... 2.21 lb <sub>f</sub> -ft)		
48, 63, 80, 100			0.9 (1.21) 7.7 (10.3)				1.5 ... 37 Nm (1.11 ... 27.3 lb <sub>f</sub> -ft)		
Gearbox size	Maximum output torque $M_{2max}$ Nm (lb <sub>f</sub> -ft)				Gearbox ratio $i$	Catalog			
	10	100	1000	10000					
19, 29, 39, 49, 59, 69, 79, 89, 109, 129	14 (10.3)		5200 (3836)		3.4 ... 62.5	D 41			
19, 29, 39, 49, 59, 69, 79, 89, 109, 129	102 (75.2)		5000 (3688)		35.8 ... 373				
29, 39, 49, 69, 79, 89, 109, 129	17 (12.5)		5140 (3791)		3.6 ... 70.7				
29, 39, 49, 69, 79, 89, 109, 129	163 (120)		5010 (3695)		46.4 ... 413				
19, 29, 39, 49	15 (11.1)		465 (343)		3.5 ... 59.3				
39, 49, 69, 79, 89, 109, 129, 149	24 (17.7)		8160 (6019)		5.2 ... 244.3				
29, 39, 49, 69, 89	46 (33.9)		1480 (1092)		6.2 ... 102.5				

# SIMOTICS motors and SIMOGEAR geared motors

## Overview

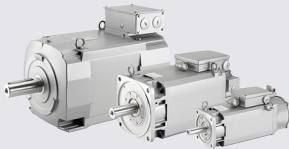
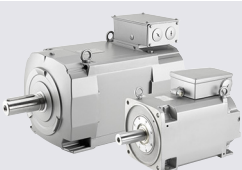
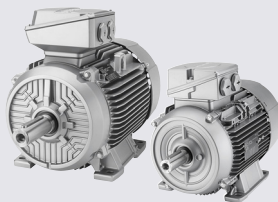
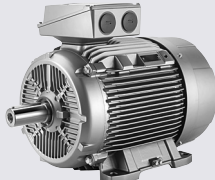
Motor type	Features	Degree of protection	Cooling method
<b>SIMOTICS M main motors</b>			
 <p><b>SIMOTICS M-1PH8 asynchronous motor</b></p>	Three-phase squirrel-cage motor without housing Compact unit with high power density	IP55	Forced ventilation
		IP23	Forced ventilation
		IP55/IP65	Water cooling
 <p><b>SIMOTICS M-1PH8 synchronous motor</b></p>	Permanent-magnet synchronous motor Outstanding performance properties Compact unit with extremely high power density	IP55	Forced ventilation
		IP55/IP65	Water cooling
<b>SIMOTICS GP and SD low-voltage motors</b>			
 <p><b>SIMOTICS GP 1LE10 and VSD10 line 1LE10 standard motors</b>  <b>SIMOTICS GP VSD4000 line 1FP10 reluctance motors</b></p>	For general purpose applications Motors with aluminum housing	IP55	Natural cooling/forced ventilation
<b>SIMOTICS XP explosion-protected motors</b>			
 <p><b>SIMOTICS XP 1MB10 explosion-protected motors</b></p>	Comprehensive series of explosion-protected motors for protection against gas and dust in potentially explosive atmospheres Motors with aluminum housing	Ex tb, Ex tc, Ex ec	Natural cooling

## SIMOTICS motors and SIMOGEAR geared motors

Overview

Shaft height (SH)	Rated power $P_N$ for S1 duty kW (hp)							Rated torque $M_N$	Catalog
	0.01	0.1	1	10	100	1000	10000		
80, 100, 132, 160, 180, 225, 280				7.2 (9.66) 270 (362)				10 ... 2481 Nm (7.38 ... 1830 lb <sub>f</sub> -ft)	D 21.4 NC 62
180, 225, 280				24.5 (32.9) 630 (845)				317 ... 3710 Nm (234 ... 2737 lb <sub>f</sub> -ft)	
80, 100, 132, 160, 180, 225, 280				4.0 (5.36) 265 (355)				14 ... 2598 Nm (10.3 ... 1916 lb <sub>f</sub> -ft)	
132, 160, 180, 225				18.0 (24.1) 195 (262)				95 ... 1086 Nm (70.1 ... 801 lb <sub>f</sub> -ft)	
132, 160, 180, 225				20.0 (26.8) 238 (319)				108 ... 1647 Nm (79.7 ... 1215 lb <sub>f</sub> -ft)	
63, 71, 80, 90, 100, 112, 132, 160, 180, 200			0.09 (0.12) 45 (60.4)					0.6 ... 294 Nm (0.44 ... 217 lb <sub>f</sub> -ft)	D 81.1
71, 80, 90, 100, 112, 132, 160, 180, 200, 225, 250, 280, 315, 355, 400, 450		0.09 (0.12) 1000 (1341)					1.0 ... 8100 Nm (0.74 ... 5975 lb <sub>f</sub> -ft)		
Shaft height (SH)	Rated power $P_N$ for S1 duty kW (hp)							Rated torque $M_N$	Catalog
	0.01	0.1	1	10	100	1000	10000		
80, 90, 100, 112, 132, 160			0.37 (0.50) 18.5 (24.8)					2.5 ... 109 Nm (1.84 ... 80.4 lb <sub>f</sub> -ft)	D 81.1
71, 80, 90, 100, 112, 132, 160, 180, 200, 225, 250, 280, 315, 355, 400, 450		0.09 (0.12) 1000 (1341)					1.2 ... 8100 Nm (0.89 ... 5975 lb <sub>f</sub> -ft)		

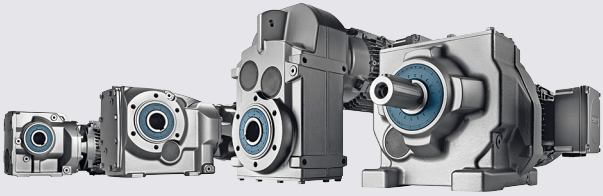

# SIMOTICS motors and SIMOGEAR geared motors

## Overview

Motor type	Features	Degree of protection	Gearbox designation
<b>SIMOGEAR 2KJ3 geared motors</b>			
 <p><b>SIMOGEAR 2KJ3 geared motors</b></p>	Helical geared motors	IP55	<p><i>Z19 ... Z189</i> (2-stage)</p> <p><i>D19 ... D189</i> (3-stage)</p> <hr/> <p><i>E39 ... E149</i> (1-stage)</p> <p><i>D29-Z19 ... D189-D69</i> (tandem geared motors 4-stage to 6-stage)</p>
	Parallel shaft geared motors	IP55	<p><i>FZ29 ... FZ189</i> (2-stage)</p> <hr/> <p><i>FD29 ... FD189</i> (3-stage)</p> <hr/> <p><i>FZ29-Z19 ... FD189-D69</i> (tandem geared motors 4-stage to 6-stage)</p>
	Bevel geared motors	IP55	<p><i>B19 ... B49</i> (2-stage)</p> <p><i>K39 ... K129</i> (3-stage)</p> <hr/> <p><i>K39-D/Z19 ... K189-D/Z69</i> (tandem geared motors 5-stage and 6-stage)</p>
	Helical worm geared motors	IP55	<p><i>C29 ... C89</i> (2-stage)</p> <hr/> <p><i>C29-D/Z19 ... C89-D/Z39</i> (tandem geared motors 4-stage and 5-stage)</p>
	Worm geared motors	IP55	<i>S09 ... S29</i> (1-stage)

## SIMOTICS motors and SIMOGEAR geared motors

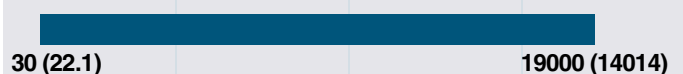
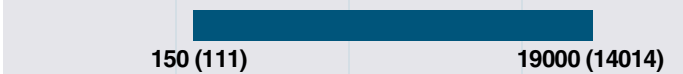
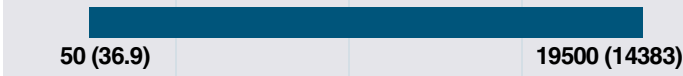
Overview

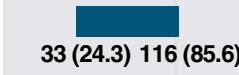
Gearbox size	Maximum output torque $M_{2max}$ Nm (lb <sub>f</sub> -ft)					Gearbox ratio $i$	Catalog
	10	100	1000	10000	100000		
19, 29, 39, 49, 59, 69, 79, 89, 109, 129, 149, 169, 189						1.29 ... 27816	D 50.1
	30 (22.1)			19000 (14014)			
29, 39, 49, 69, 79, 89, 109, 129, 149, 169, 189						4 ... 29900	
		150 (111)		19000 (14014)			
19, 29, 39, 49, 69, 79, 89, 109, 129, 149, 169, 189						3.6 ... 14900	
		50 (36.9)		19500 (14383)			
29, 39A, 49, 69, 89						6.5 ... 19000	
		61 (45.0)	1450 (1070)				
09, 19, 29						5.0 ... 100	
		33 (24.3)	116 (85.6)				

## SIMOTICS motors and SIMOGEAR geared motors

SIMOTICS S-1FK7 servomotors for SINAMICS S110/SINAMICS S120

### SIMOTICS S-1FK7 Compact synchronous motors – Natural cooling > Preferred type

#### Selection and ordering data

Rated speed	Shaft height	Rated power	Static torque	Rated torque	Rated current	<b>SIMOTICS S-1FK7 Compact synchronous motors</b>  <b>Preferred type</b>  Article No.	Number of pole pairs	Moment of inertia of rotor (without brake)	Weight (without brake)
$n_N$	SH	$P_N$ at $\Delta T=100\text{ K}$	$M_0$ at $\Delta T=100\text{ K}$	$M_N$ at $\Delta T=100\text{ K}$	$I_N$ at $\Delta T=100\text{ K}$		$p$	$J$	$m$
rpm		kW (hp)	Nm (lb <sub>f</sub> -ft)	Nm (lb <sub>f</sub> -ft)	A			$10^{-4}\text{ kgm}^2$ ( $10^{-3}\text{ lb}_f\text{-in-s}^2$ )	kg (lb)
<b>1FK7 Compact for DC link voltage 510 ... 720 V DC – Natural cooling</b>									
<b>6000</b>	36	0.5 (0.67)	1.15 (0.85)	0.8 (0.59)	1.3	<b>1FK7032-2AK71-1 ■ ■ 0</b>	3	0.65 (0.58)	2.7 (5.95)
<b>3000</b>	48	0.8 (1.07)	3 (2.21)	2.6 (1.92)	2	<b>1FK7042-2AF71-1 ■ ■ 0</b>	4	2.9 (2.57)	4.6 (10.1)
	63	1.5 (2.01)	6 (4.43)	4.7 (3.47)	3.7	<b>1FK7060-2AF71-1 ■ ■ 0</b>	4	7.7 (6.82)	7.1 (15.7)
		2.3 (3.08)	11 (8.11)	7.3 (5.38)	5.6	<b>1FK7063-2AF71-1 ■ ■ 0</b>	4	14.7 (13.0)	11.1 (24.5)
<b>2000</b>	80	2.6 (3.49)	16 (11.8)	12.5 (9.22)	6.3	<b>1FK7083-2AC71-1 ■ ■ 0</b>	4	26 (23.0)	15.6 (34.4)
	100	4.3 (5.77)	27 (19.9)	20.5 (15.1)	9.7	<b>1FK7101-2AC71-1 ■ ■ 0</b>	4	79 (69.9)	23 (50.7)
<b>Encoder systems for motors with DRIVE-CLiQ interface:</b>			AS20DQI encoder – single-turn absolute encoder			Q			
			AM20DQI encoder – multi-turn absolute encoder				R		
<b>Shaft extension:</b>			<b>Shaft and flange accuracy:</b>			<b>Holding brake:</b>			
Feather key			Tolerance N			Without		A	
Feather key			Tolerance N			With		B	
Plain shaft			Tolerance N			Without		G	
Plain shaft			Tolerance N			With		H	
<b>Degree of protection:</b>			IP64					0	
			IP64					3	



## SIMOTICS motors and SIMOGEAR geared motors

### SIMOTICS S-1FK7 servomotors for SINAMICS S110/SINAMICS S120

#### SIMOTICS S-1FK7 Compact synchronous motors – Natural cooling > Preferred type

Motor type (repeated)	Efficiency 1)	Stall current	Calculated power $P_{\text{calc}} = M_0 \times \eta_N / 9550$	For SINAMICS S110/SINAMICS S120		Power cable with complete shield		
				Rated output current <sup>2)</sup>	PM240-2 Power Module Internal air cooling For further components, see SINAMICS S110/ SINAMICS S120 drive system	Motor connection (and brake connection) via SPEED-CONNECT power connector		
						$I_N$	Article No.	Power connector
%	A	kW (hp)	A	Line voltage 380 ... 480 V 3 AC	Size	mm <sup>2</sup>	Article No.	
1FK7032-2AK71...	88	1.7	0.7 (0.94)	2.2	6SL3210-1PE12-3 L1	1	4 × 1.5	6FX 002-5 G10-....
1FK7042-2AF71...	89	2.2	0.9 (1.21)	3.1	6SL3210-1PE13-2 L1	1	4 × 1.5	6FX 002-5 G10-....
1FK7060-2AF71...	90	4.45	1.9 (2.55)	7.7	6SL3210-1PE18-0 L1	1	4 × 1.5	6FX 002-5 G10-....
1FK7063-2AF71...	91	8	3.5 (4.69)	13.2	6SL3210-1PE21-4 L0	1	4 × 1.5	6FX 002-5 G10-....
1FK7083-2AC71...	93	7.5	3.4 (4.56)	10.2	6SL3210-1PE21-1 L0	1	4 × 1.5	6FX 002-5 G10-....
1FK7101-2AC71...	93	12.3	5.7 (7.64)	18	6SL3210-1PE21-8 L0	1.5	4 × 1.5	6FX 002-5 G22-....

**Line filter:**Without  
IntegratedU  
A**Power cable:**MOTION-CONNECT 800PLUS  
MOTION-CONNECT 5008  
5

Without brake cores

With brake cores<sup>4)</sup>C  
D

Length code

....

For further information about cables,  
see MOTION-CONNECT connection systems  
in Catalog D 21.4 or:  
[www.siemens.com/industrymall](http://www.siemens.com/industrymall)

<sup>1)</sup> Optimum efficiency in continuous duty.

<sup>2)</sup> With default setting of the pulse frequency.

<sup>3)</sup> The current carrying capacity of the power cables complies with EN 60204-1 for installation type C, for continuous duty at an ambient air temperature of 40 °C (104 °F).

<sup>4)</sup> Cable cross-section for brake connection 2 × 1.5 mm<sup>2</sup>.

## SIMOTICS motors and SIMOGEAR geared motors

SIMOTICS S-1FK7 servomotors for SINAMICS S110/SINAMICS S120

## SIMOTICS S-1FK7 Compact synchronous motors – Natural cooling

## Selection and ordering data

Rated speed	Shaft height	Rated power	Static torque	Rated torque	Rated current	SIMOTICS S-1FK7 Compact synchronous motors	Number of pole pairs	Moment of inertia of rotor (without brake)	Weight (without brake)
$n_N$	SH	$P_N$ at $\Delta T=100\text{ K}$	$M_0$ at $\Delta T=100\text{ K}$	$M_N$ at $\Delta T=100\text{ K}$	$I_N$ at $\Delta T=100\text{ K}$		$p$	$J$	$m$
rpm		kW (hp)	Nm (lb <sub>r</sub> -ft)	Nm (lb <sub>r</sub> -ft)	A	Article No.	$10^{-4}\text{ kgm}^2$ ( $10^{-3}\text{ lb}_r\text{-in-s}^2$ )	kg (lb)	
<b>1FK7 Compact for DC link voltage 510 ... 720 V DC – Natural cooling</b>									
<b>6000</b>	20	0.05 (0.07)	0.18 (0.13)	0.08 (0.06)	0.85	<b>1FK7011-5AK7</b> ■-1 ■ ■ ■ ■	4	0.064 (0.06)	0.9 (1.98)
		0.1 (0.13)	0.35 (0.26)	0.16 (0.12)	0.85	<b>1FK7015-5AK7</b> ■-1 ■ ■ ■ ■	4	0.083 (0.07)	1.1 (2.43)
	28	0.38 (0.51)	0.85 (0.63)	0.6 (0.44)	1.4	<b>1FK7022-5AK7</b> ■-1 ■ ■ ■ ■	3	0.28 (0.25)	1.8 (3.97)
<b>1FK7 Compact for DC link voltage 270 ... 330 V DC – Natural cooling</b>									
<b>6000</b>	20	0.05 (0.07)	0.18 (0.13)	0.08 (0.06)	0.5	<b>1FK7011-5AK2</b> ■-1 ■ ■ ■ ■	4	0.064 (0.06)	0.9 (1.98)
		0.1 (0.13)	0.35 (0.26)	0.16 (0.12)	0.5	<b>1FK7015-5AK2</b> ■-1 ■ ■ ■ ■	4	0.083 (0.07)	1.1 (2.43)
	28	0.38 (0.51)	0.85 (0.63)	0.6 (0.44)	1.4	<b>1FK7022-5AK2</b> ■-1 ■ ■ ■ ■	3	0.28 (0.25)	1.8 (3.97)
<b>Encoder systems for motors without DRIVE-CLiQ interface:</b>		IC2048S/R encoder				4	<b>A</b>		
		AM512S/R encoder (only for 1FK702)				4	<b>H</b>		
		AM16S/R encoder (only for 1FK701)				4	<b>J</b>		
		Multi-pole resolver				4	<b>S</b>		
		2-pole resolver				4	<b>T</b>		
<b>Encoder systems for motors with DRIVE-CLiQ interface:</b> (Only for 1FK702) <sup>1)</sup>		IC22DQ encoder				1	<b>D</b>		
		AM20DQ encoder				1	<b>L</b>		
		R15DQ resolver				1	<b>U</b>		
		R14DQ resolver				1	<b>P</b>		
<b>Shaft extension:</b>		<b>Shaft and flange accuracy:</b>		<b>Holding brake:</b>					
Feather key		Tolerance N		Without				<b>A</b>	
Feather key		Tolerance N		With				<b>B</b>	
Plain shaft		Tolerance N		Without				<b>G</b>	
Plain shaft		Tolerance N		With				<b>H</b>	
<b>Degree of protection:</b>		<b>Painting:</b>							
IP64 (only for 1FK702)		Without						<b>0</b>	
IP65 and DE flange IP67 (only for 1FK702)		Without						<b>2</b>	
IP54 (only for 1FK701). IP64 (only for 1FK702)		With						<b>3</b>	
IP65 and DE flange IP67 (only for 1FK702)		With						<b>5</b>	

<sup>1)</sup> 1FK701 motors cannot be operated with a DRIVE-CLiQ interface. The encoder systems are connected via SMC.

## SIMOTICS motors and SIMOGEAR geared motors

### SIMOTICS S-1FK7 servomotors for SINAMICS S110/SINAMICS S120

#### SIMOTICS S-1FK7 Compact synchronous motors – Natural cooling

Motor type (repeated)	Efficiency <sup>1)</sup>	Stall current $I_0$ at $M_0$ $\Delta T=100$ K	Calculated power $P_{calc} = M_0 \times n_N / 9550$  $P_{calc}$ at $M_0$ $\Delta T=100$ K	For SINAMICS S110/SINAMICS S120		Power cable with complete shield Motor connection (and brake connection) via SPEED-CONNECT power connector		
	$\eta$ %			Rated output current <sup>2)</sup> $I_N$ A	PM240-2 Power Module Internal air cooling  For further components, see SINAMICS S110/ SINAMICS S120 drive system  Article No.	Power connector Size	Cable cross-section <sup>3)</sup> mm <sup>2</sup>	Prefabricated cable Article No.
<b>Line voltage 380 ... 480 V 3 AC</b>								
1FK7011-5AK7-...	62	1.5	0.1 (0.13)	2.2	<b>6SL3210-1PE12-3 L1</b>	0.5	4 × 1.5	<b>6FX 002-5 D N30-...</b>
1FK7015-5AK7-...	68	1.5	0.2 (0.27)	2.2	<b>6SL3210-1PE12-3 L1</b>	0.5	4 × 1.5	<b>6FX 002-5 D N30-...</b>
1FK7022-5AK7-...	86	1.8	0.5 (0.67)	3.1	<b>6SL3210-1PE13-2 L1</b>	1	4 × 1.5	<b>6FX 002-5 G10-...</b>
<b>Line voltage 200 ... 240 V 1 AC</b>								
1FK7011-5AK2-...	62	0.85	0.1 (0.13)	3.2	<b>6SL3210-1PB13-0 L0</b>	0.5	4 × 1.5	<b>6FX 002-5 D N30-...</b>
1FK7015-5AK2-...	68	0.85	0.2 (0.27)	3.2	<b>6SL3210-1PB13-0 L0</b>	0.5	4 × 1.5	<b>6FX 002-5 D N30-...</b>
1FK7022-5AK2-...	88	1.8	0.5 (0.67)	3.2	<b>6SL3210-1PB13-0 L0</b>	1	4 × 1.5	<b>6FX 002-5 G10-...</b>

<b>Line filter:</b> Without Integrated	<b>U A</b>	<b>Power cable:</b> MOTION-CONNECT 800PLUS MOTION-CONNECT 500	<b>8 5</b>	<b>C D</b>
		Without brake cores With brake cores <sup>4)</sup>		
		Length code		....

For further information about cables,  
see MOTION-CONNECT connection systems  
in Catalog D 21.4 or:  
[www.siemens.com/industrymall](http://www.siemens.com/industrymall)

1) Optimum efficiency in continuous duty.

2) With default setting of the pulse frequency.

3) The current carrying capacity of the power cables complies with EN 60204-1 for installation type C, for continuous duty at an ambient air temperature of 40 °C (104 °F).

4) Cable cross-section for brake connection 2 × 1.5 mm<sup>2</sup>.

# SIMOTICS motors and SIMOGEAR geared motors

SIMOTICS S-1FK7 servomotors for SINAMICS S110/SINAMICS S120

## SIMOTICS S-1FK7 Compact synchronous motors – Natural cooling

### Selection and ordering data

Rated speed	Shaft height	Rated power	Static torque	Rated torque	Rated current	SIMOTICS S-1FK7 Compact synchronous motors	Number of pole pairs	Moment of inertia of rotor (without brake)	Weight (without brake)
$n_N$	SH	$P_N$ at $\Delta T=100\text{ K}$	$M_0$ at $\Delta T=100\text{ K}$	$M_N$ at $\Delta T=100\text{ K}$	$I_N$ at $\Delta T=100\text{ K}$	Article No.	$p$	$J$	$m$
rpm		kW (hp)	Nm (lb <sub>f</sub> -ft)	Nm (lb <sub>f</sub> -ft)	A			$10^{-4}\text{ kgm}^2$ ( $10^{-3}\text{ lb}_f\text{-in-s}^2$ )	kg (lb)

#### 1FK7 Compact for DC link voltage 510 ... 720 V DC – Natural cooling

<b>2000</b>	48	0.6 (0.80)	3 (2.21)	2.8 (2.07)	1.55	<b>1FK7042-2AC7</b> ■-1 ■■■■	4	2.9 (2.57)	4.6 (10.1)
	63	1.1 (1.48)	6 (4.43)	5.3 (3.91)	2.95	<b>1FK7060-2AC7</b> ■-1 ■■■■	4	7.7 (6.82)	7.1 (15.7)
		1.5 (2.01)	8.5 (6.27)	7 (5.16)	2.65	<b>1FK7062-2AC7</b> ■-1 ■■■■	4	11.2 (9.91)	9.1 (20.1)
		1.9 (2.55)	11 (8.11)	8.9 (6.56)	4.4	<b>1FK7063-2AC7</b> ■-1 ■■■■	4	14.7 (13.0)	11.1 (24.5)
	80	2.1 (2.82)	12 (8.85)	10 (7.38)	4.4	<b>1FK7081-2AC7</b> ■-1 ■■■■	4	20 (17.7)	12.9 (28.4)
		2.6 (3.49)	16 (11.8)	12.5 (9.22)	6.3	<b>1FK7083-2AC7</b> ■-1 ■■■■	4	26 (23.0)	15.6 (34.4)
		3.1 (4.16)	20 (14.8)	15 (11.1)	6.7	<b>1FK7084-2AC7</b> ■-1 ■■■■	4	32.5 (28.8)	18.3 (40.3)
	100	3 (4.02)	18 (13.3)	14.5 (10.7)	7.1	<b>1FK7100-2AC7</b> ■-1 ■■■■	4	54 (47.8)	17.6 (38.8)
		4.3 (5.77)	27 (19.9)	20.5 (15.1)	9.7	<b>1FK7101-2AC7</b> ■-1 ■■■■	4	79 (69.9)	23 (50.7)
		5.2 (6.97)	36 (26.6)	25 (18.4)	11	<b>1FK7103-2AC7</b> ■-1 ■■■■	4	104 (92.1)	28.5 (62.8)
		7.7 (10.3)	48 (35.4)	37 (27.3)	16	<b>1FK7105-2AC7</b> ■-1 ■■■■	4	154 (136)	39 (86.0)
	<b>3000</b>	48	0.8 (1.07)	3 (2.21)	2.6 (1.92)	2	<b>1FK7042-2AF7</b> ■-1 ■■■■	4	2.9 (2.57)
63		1.5 (2.01)	6 (4.43)	4.7 (3.47)	3.7	<b>1FK7060-2AF7</b> ■-1 ■■■■	4	7.7 (6.82)	7.1 (15.7)
		1.9 (2.55)	8.5 (6.27)	6 (4.43)	4	<b>1FK7062-2AF7</b> ■-1 ■■■■	4	11.2 (9.91)	9.1 (20.1)
		2.3 (3.08)	11 (8.11)	7.3 (5.38)	5.6	<b>1FK7063-2AF7</b> ■-1 ■■■■	4	14.7 (13.0)	11.1 (24.5)
80		2.1 (2.82)	8 (5.90)	6.8 (5.02)	4.4	<b>1FK7080-2AF7</b> ■-1 ■■■■	4	14.2 (12.6)	10.3 (22.7)
		2.7 (3.62)	12 (8.85)	8.7 (6.42)	6.8	<b>1FK7081-2AF7</b> ■-1 ■■■■	4	20 (17.7)	12.9 (28.4)
		3.3 (4.43)	16 (11.8)	10.5 (7.74)	7.2	<b>1FK7083-2AF7</b> ■-1 ■■■■	4	26 (23.0)	15.6 (34.4)
		3.1 (4.16)	20 (14.8)	10 (7.38)	6.5	<b>1FK7084-2AF7</b> ■-1 ■■■■	4	32.5 (28.8)	18.3 (40.3)
100		3.8 (5.10)	18 (13.3)	12 (8.85)	8	<b>1FK7100-2AF7</b> ■-1 ■■■■	4	54 (47.8)	17.6 (38.8)
		4.9 (6.57)	27 (19.9)	15.5 (11.4)	11.6	<b>1FK7101-2AF7</b> ■-1 ■■■■	4	79 (69.9)	23 (50.7)
		4.4 (5.90)	36 (26.6)	14 (10.3)	11.5	<b>1FK7103-2AF7</b> ■-1 ■■■■	4	104 (92.1)	28.5 (62.8)
		8.2 (11.0)	48 (35.4)	26 (19.2)	18	<b>1FK7105-2AF7</b> ■-1 ■■■■	4	154 (136)	39 (86.0)

<b>Encoder systems for motors without DRIVE-CLiQ interface:</b>	IC2048S/R encoder	4	A		
	AM2048S/R encoder	4	E		
	Multi-pole resolver	4	S		
	2-pole resolver	4	T		
<b>Encoder systems for motors with DRIVE-CLiQ interface:</b>	AS24DQI encoder	1	B		
	AM24DQI encoder	1	C		
	AS20DQI encoder	1	Q		
	AM20DQI encoder	1	R		
	R15DQ resolver	1	U		
	R14DQ resolver	1	P		
<b>Shaft extension:</b>	Feather key	Shaft and flange accuracy:	Holding brake:		
	Feather key			Tolerance N	Without
	Plain shaft			Tolerance N	With
	Plain shaft			Tolerance N	Without
			With		
<b>Degree of protection:</b>	IP64	0			
	IP65		1		
	IP65 and DE flange IP67		2		

11

## SIMOTICS motors and SIMOGEAR geared motors

### SIMOTICS S-1FK7 servomotors for SINAMICS S110/SINAMICS S120

#### SIMOTICS S-1FK7 Compact synchronous motors – Natural cooling

Motor type (repeated)	Efficiency <sup>1)</sup> $\eta$ %	Stall current $I_0$ at $M_0$ $\Delta T=100$ K A	Calculated power $P_{calc} = M_0 \times \eta_N / 9550$ $P_{calc}$ at $M_0$ $\Delta T=100$ K kW (hp)	For SINAMICS S110/SINAMICS S120		Power cable with complete shield Motor connection (and brake connection) via SPEED-CONNECT power connector		
				Rated output current <sup>2)</sup> $I_N$ A	PM240-2 Power Module Internal air cooling For further components, see SINAMICS S110/ SINAMICS S120 drive system Article No.	Power connector Size	Cable cross-section <sup>3)</sup> mm <sup>2</sup>	Prefabricated cable Article No.
Line voltage 380 ... 480 V 3 AC								
1FK7042-2AC7.-...	88	1.6	0.6 (0.80)	2.2	6SL3210-1PE12-3 ■ L1	1	4 × 1.5	6FX ■ 002-5 ■ G10-....
1FK7060-2AC7.-...	90	3.15	1.3 (1.74)	5.9	6SL3210-1PE16-1 ■ L1	1	4 × 1.5	6FX ■ 002-5 ■ G10-....
1FK7062-2AC7.-...	90	3	1.8 (2.41)	4.1	6SL3210-1PE14-3 ■ L1	1	4 × 1.5	6FX ■ 002-5 ■ G10-....
1FK7063-2AC7.-...	91	5.3	2.3 (3.08)	7.7	6SL3210-1PE18-0 ■ L1	1	4 × 1.5	6FX ■ 002-5 ■ G10-....
1FK7081-2AC7.-...	93	5	2.5 (3.35)	7.7	6SL3210-1PE18-0 ■ L1	1	4 × 1.5	6FX ■ 002-5 ■ G10-....
1FK7083-2AC7.-...	93	7.5	3.4 (4.56)	10.2	6SL3210-1PE21-1 ■ L0	1	4 × 1.5	6FX ■ 002-5 ■ G10-....
1FK7084-2AC7.-...	93	8.5	4.2 (5.63)	13.2	6SL3210-1PE21-4 ■ L0	1	4 × 1.5	6FX ■ 002-5 ■ G10-....
1FK7100-2AC7.-...	92	8.4	3.8 (5.10)	13.2	6SL3210-1PE21-4 ■ L0	1	4 × 1.5	6FX ■ 002-5 ■ G10-....
1FK7101-2AC7.-...	93	12.3	5.7 (7.64)	18	6SL3210-1PE21-8 ■ L0	1.5	4 × 1.5	6FX ■ 002-5 ■ G22-....
1FK7103-2AC7.-...	93	14.4	7.5 (10.1)	18	6SL3210-1PE21-8 ■ L0	1.5	4 × 1.5	6FX ■ 002-5 ■ G22-....
1FK7105-2AC7.-...	93	20	10.1 (13.5)	26	6SL3210-1PE22-7 ■ L0	1.5	4 × 2.5	6FX ■ 002-5 ■ G32-....
1FK7042-2AF7.-...	89	2.2	0.9 (1.21)	3.1	6SL3210-1PE13-2 ■ L1	1	4 × 1.5	6FX ■ 002-5 ■ G10-....
1FK7060-2AF7.-...	90	4.45	1.9 (2.55)	7.7	6SL3210-1PE18-0 ■ L1	1	4 × 1.5	6FX ■ 002-5 ■ G10-....
1FK7062-2AF7.-...	91	5.3	2.7 (3.62)	7.7	6SL3210-1PE18-0 ■ L1	1	4 × 1.5	6FX ■ 002-5 ■ G10-....
1FK7063-2AF7.-...	91	8	3.5 (4.69)	13.2	6SL3210-1PE21-4 ■ L0	1	4 × 1.5	6FX ■ 002-5 ■ G10-....
1FK7080-2AF7.-...	92	4.9	2.5 (3.35)	7.7	6SL3210-1PE18-0 ■ L1	1	4 × 1.5	6FX ■ 002-5 ■ G10-....
1FK7081-2AF7.-...	93	8.7	3.8 (5.10)	13.2	6SL3210-1PE21-4 ■ L0	1	4 × 1.5	6FX ■ 002-5 ■ G10-....
1FK7083-2AF7.-...	93	10.1	5 (6.71)	13.2	6SL3210-1PE21-4 ■ L0	1	4 × 1.5	6FX ■ 002-5 ■ G10-....
1FK7084-2AF7.-...	93	12.1	6.3 (8.45)	18	6SL3210-1PE21-8 ■ L0	1	4 × 1.5	6FX ■ 002-5 ■ G10-....
1FK7100-2AF7.-...	92	11.1	5.7 (7.64)	18	6SL3210-1PE21-8 ■ L0	1	4 × 1.5	6FX ■ 002-5 ■ G10-....
1FK7101-2AF7.-...	93	18.8	8.5 (11.4)	26	6SL3210-1PE22-7 ■ L0	1.5	4 × 2.5	6FX ■ 002-5 ■ G32-....
1FK7103-2AF7.-...	93	26	11.3 (15.2)	32	6SL3210-1PE23-3 ■ L0	1.5	4 × 4	6FX ■ 002-5 ■ G42-....
1FK7105-2AF7.-...	94	31	15.1 (20.2)	32	6SL3210-1PE23-3 ■ L0	1.5	4 × 6	6FX ■ 002-5 ■ G52-....

Line filter:  
Without  
Integrated

U  
A

Power cable:

MOTION-CONNECT 800PLUS 8  
MOTION-CONNECT 500 5

Without brake cores  
With brake cores<sup>4)</sup> C  
D

Length code

For further information about cables,  
see MOTION-CONNECT connection systems  
in Catalog D 21.4 or:

[www.siemens.com/industrymall](http://www.siemens.com/industrymall)

<sup>1)</sup> Optimum efficiency in continuous duty.

<sup>2)</sup> With default setting of the pulse frequency.

<sup>3)</sup> The current carrying capacity of the power cables complies with EN 60204-1 for installation type C, for continuous duty at an ambient air temperature of 40 °C (104 °F).

<sup>4)</sup> Cable cross-section for brake connection 2 × 1.5 mm<sup>2</sup>.

# SIMOTICS motors and SIMOGEAR geared motors

SIMOTICS S-1FK7 servomotors for SINAMICS S110/SINAMICS S120

## SIMOTICS S-1FK7 Compact synchronous motors – Natural cooling

### Selection and ordering data

Rated speed	Shaft height	Rated power	Static torque	Rated torque	Rated current	SIMOTICS S-1FK7 Compact synchronous motors  Article No.	Number of pole pairs	Moment of inertia of rotor (without brake)	Weight (without brake)		
$n_N$	SH	$P_N$ at $\Delta T=100\text{ K}$	$M_0$ at $\Delta T=100\text{ K}$	$M_N$ at $\Delta T=100\text{ K}$	$I_N$ at $\Delta T=100\text{ K}$		$p$	$J$	$m$		
rpm		kW (hp)	Nm (lb <sub>f</sub> -ft)	Nm (lb <sub>f</sub> -ft)	A			$10^{-4}\text{ kgm}^2$ ( $10^{-3}\text{ lb}_f\text{-in-s}^2$ )	kg (lb)		
<b>1FK7 Compact for DC link voltage 510 ... 720 V DC – Natural cooling</b>											
<b>4500</b>	63	1.7 (2.28)	6 (4.43)	3.7 (2.73)	4.3	<b>1FK7060-2AH7 -1</b> ■■■	4	7.7 (6.82)	7.1 (15.7)		
		1.4 (1.88)	8.5 (6.27)	3 (2.21)	3.3	<b>1FK7062-2AH7 -1</b> ■■■	4	11.2 (9.91)	9.1 (20.1)		
		1.4 (1.88)	11 (8.11)	3 (2.21)	3.8	<b>1FK7063-2AH7 -1</b> ■■■	4	14.7 (13.0)	11.1 (24.5)		
	80	2.1 (2.82)	8 (5.90)	4.5 (3.32)	4.8	<b>1FK7080-2AH7 -1</b> ■■■	4	14.2 (12.6)	10.3 (22.7)		
		1.8 (2.41)	12 (8.85)	3.8 (2.80)	4.9	<b>1FK7081-2AH7 -1</b> ■■■	4	20 (17.7)	12.9 (28.4)		
		1.4 (1.88)	16 (11.8)	3 (2.21)	3.6	<b>1FK7083-2AH7 -1</b> ■■■	4	26 (23.0)	15.6 (34.4)		
<b>6000</b>	36	0.5 (0.67)	1.15 (0.85)	0.8 (0.59)	1.3	<b>1FK7032-2AK7 -1</b> ■■■	3	0.65 (0.58)	2.7 (5.95)		
		0.6 (0.80)	1.6 (1.18)	1 (0.74)	1.3	<b>1FK7034-2AK7 -1</b> ■■■	3	0.9 (0.80)	3.5 (7.72)		
	48	0.7 (0.94)	1.6 (1.18)	1.1 (0.81)	1.85	<b>1FK7040-2AK7 -1</b> ■■■	4	1.6 (1.42)	3.2 (7.05)		
		0.9 (1.21)	3 (2.21)	1.5 (1.11)	2.5	<b>1FK7042-2AK7 -1</b> ■■■	4	2.9 (2.57)	4.6 (10.1)		
		<b>1FK7 Compact for DC link voltage 270 ... 330 V DC – Natural cooling</b>									
		<b>3000</b>	36	0.3 (0.40)	1.15 (0.85)	1 (0.74)	1.6	<b>1FK7032-2AF2 -1</b> ■■■	3	0.65 (0.58)	2.7 (5.95)
0.5 (0.67)	1.6 (1.18)			1.45 (1.07)	1.8	<b>1FK7034-2AF2 -1</b> ■■■	3	0.9 (0.80)	3.5 (7.72)		
48	0.8 (1.07)		3 (2.21)	2.6 (1.92)	3.5	<b>1FK7042-2AF2 -1</b> ■■■	4	2.9 (2.57)	4.6 (10.1)		
<b>Encoder systems for motors without DRIVE-CLiQ interface:</b>		IC2048S/R encoder				4	<b>A</b>				
		AM2048S/R encoder				4	<b>E</b>				
		Multi-pole resolver				4	<b>S</b>				
		2-pole resolver				4	<b>T</b>				
<b>Encoder systems for motors with DRIVE-CLiQ interface:</b>		AS24DQI encoder				1	<b>B</b>				
		AM24DQI encoder				1	<b>C</b>				
		AS20DQI encoder				1	<b>Q</b>				
		AM20DQI encoder				1	<b>R</b>				
		R15DQ resolver				1	<b>U</b>				
		R14DQ resolver				1	<b>P</b>				
<b>Shaft extension:</b>		<b>Shaft and flange accuracy:</b>		<b>Holding brake:</b>							
Feather key		Tolerance N		Without					<b>A</b>		
Feather key		Tolerance N		With					<b>B</b>		
Plain shaft		Tolerance N		Without					<b>G</b>		
Plain shaft		Tolerance N		With					<b>H</b>		
<b>Degree of protection:</b>		IP64							<b>0</b>		
		IP65							<b>1</b>		
		IP65 and DE flange IP67							<b>2</b>		

## SIMOTICS motors and SIMOGEAR geared motors

### SIMOTICS S-1FK7 servomotors for SINAMICS S110/SINAMICS S120

#### SIMOTICS S-1FK7 Compact synchronous motors – Natural cooling

Motor type (repeated)	Efficiency <sup>1)</sup>	Stall current $I_0$ at $M_0$ $\Delta T=100$ K	Calculated power $P_{calc} = M_0 \times n_N / 9550$  $P_{calc}$ at $M_0$ $\Delta T=100$ K	For SINAMICS S110/SINAMICS S120		Power cable with complete shield Motor connection (and brake connection) via SPEED-CONNECT power connector		
	$\eta$  %			Rated output current <sup>2)</sup>  $I_N$  A	PM240-2 Power Module Internal air cooling  For further components, see SINAMICS S110/ SINAMICS S120 drive system  Article No.	Power connector	Cable cross-section <sup>3)</sup>  mm <sup>2</sup>	Prefabricated cable  Article No.
<b>Line voltage 380 ... 480 V 3 AC</b>								
1FK7060-2AH7.-...	90	6.3	2.8 (3.75)	10.2	<b>6SL3210-1PE21-1 L0</b>	1	4 × 1.5	<b>6FX 002-5 G10-....</b>
1FK7062-2AH7.-...	91	8	4 (5.36)	13.2	<b>6SL3210-1PE21-4 L0</b>	1	4 × 1.5	<b>6FX 002-5 G10-....</b>
1FK7063-2AH7.-...	90	12	5.2 (6.97)	18	<b>6SL3210-1PE21-8 L0</b>	1	4 × 1.5	<b>6FX 002-5 G10-....</b>
1FK7080-2AH7.-...	92	7.4	3.8 (5.10)	10.2	<b>6SL3210-1PE21-1 L0</b>	1	4 × 1.5	<b>6FX 002-5 G10-....</b>
1FK7081-2AH7.-...	93	13.1	5.7 (7.64)	18	<b>6SL3210-1PE21-8 L0</b>	1	4 × 1.5	<b>6FX 002-5 G10-....</b>
1FK7083-2AH7.-...	93	15	7.5 (10.1)	18	<b>6SL3210-1PE21-8 L0</b>	1	4 × 1.5	<b>6FX 002-5 G10-....</b>
1FK7032-2AK7.-...	88	1.7	0.7 (0.94)	2.2	<b>6SL3210-1PE12-3 L1</b>	1	4 × 1.5	<b>6FX 002-5 G10-....</b>
1FK7034-2AK7.-...	88	1.9	1 (1.34)	3.1	<b>6SL3210-1PE13-1 L1</b>	1	4 × 1.5	<b>6FX 002-5 G10-....</b>
1FK7040-2AK7.-...	88	2.35	1 (1.34)	4.1	<b>6SL3210-1PE14-1 L1</b>	1	4 × 1.5	<b>6FX 002-5 G10-....</b>
1FK7042-2AK7.-...	89	4.4	1.9 (2.55)	7.7	<b>6SL3210-1PE18-0 L1</b>	1	4 × 1.5	<b>6FX 002-5 G10-....</b>
<b>Line voltage 200 ... 240 V 1 AC</b>								
1FK7032-2AF2.-...	85	1.7	0.4 (0.54)	3.2	<b>6SL3210-1PB13-0 L0</b>	1	4 × 1.5	<b>6FX 002-5 G10-....</b>
1FK7034-2AF2.-...	85	1.9	0.5 (0.67)	3.2	<b>6SL3210-1PB13-0 L0</b>	1	4 × 1.5	<b>6FX 002-5 G10-....</b>
1FK7042-2AF2.-...	88	3.95	0.9 (1.21)	6	<b>6SL3210-1PB15-5 L0</b>	1	4 × 1.5	<b>6FX 002-5 G10-....</b>

**Line filter:**Without  
IntegratedU  
A**Power cable:**MOTION-CONNECT 800PLUS **8**  
MOTION-CONNECT 500 **5**Without brake cores  
With brake cores<sup>4)</sup>C  
D

Length code

....

For further information about cables,  
see MOTION-CONNECT connection systems  
in Catalog D 21.4 or:[www.siemens.com/industrymall](http://www.siemens.com/industrymall)

1) Optimum efficiency in continuous duty.

2) With default setting of the pulse frequency.

3) The current carrying capacity of the power cables complies with EN 60204-1 for installation type C, for continuous duty at an ambient air temperature of 40 °C (104 °F).

4) Cable cross-section for brake connection 2 × 1.5 mm<sup>2</sup>.

**SIMOTICS motors and SIMOGEAR geared motors**

SIMOTICS M-1PH8 main motors for SINAMICS S110/SINAMICS S120

**SIMOTICS M-1PH8 asynchronous motors – Forced ventilation, IP55 degree of protection****Selection and ordering data**

Rated speed	Shaft height	Rated power	Rated torque	Rated current	Rated voltage	Rated frequency	Operating speed during field weakening, max. <sup>1)</sup>	Speed, max. <sup>2)</sup>	SIMOTICS M-1PH8 asynchronous motors
$n_N$ rpm	SH	$P_N$ kW (hp)	$M_N$ Nm (lb <sub>F</sub> -ft)	$I_N$ A	$U_N$ V	$f_N$ Hz	$n_2$ rpm	$n_{max}$ rpm	Article No.
<b>1PH8 for line voltage 400 V 3 AC – Forced ventilation NDE → DE</b>									
<b>400</b>	160	9.5 (12.7)	227 (167)	30	260	14.3	2150	6500	<b>1PH8163-1 B1 - ■■■■2</b>
		13 (17.4)	310 (229)	36	300	14.1	1750	6500	<b>1PH8165-1 B1 - ■■■■2</b>
<b>1000</b>	100	3.7 (4.96)	35 (25.8)	10	333	35.8	2550	9000	<b>1PH8103-1 D1 - ■■■■2</b>
		6.3 (8.45)	60 (44.3)	17.5	307	35.5	4300	9000	<b>1PH8107-1 D1 - ■■■■2</b>
	132	7.9 (10.6)	75 (55.3)	20	316	34.8	3000	8000	<b>1PH8131-1 D1 - ■■■■2</b>
		12 (16.1)	115 (84.8)	30	319	35	3000	8000	<b>1PH8133-1 D1 - ■■■■2</b>
		17 (22.8)	162 (119)	43	307	34.8	4300	8000	<b>1PH8137-1 D1 - ■■■■2</b>
	160	22 (29.5)	210 (155)	55	300	34.2	2800	6500	<b>1PH8163-1 D1 - ■■■■2</b>
		28 (37.5)	267 (197)	71	292	34.2	4600	6500	<b>1PH8165-1 D1 - ■■■■2</b>
	<b>1500</b>	80	2.8 (3.75)	18 (13.3)	7.5	346	53.3	4700	10000
3.7 (4.96)			24 (17.7)	10	336	53.2	5200	10000	<b>1PH8087-1 F1 - ■■■■2</b>
100		3.7 (4.96)	24 (17.7)	12.5	265	52.4	5000	9000	<b>1PH8101-1 F1 - ■■■■2</b>
		5.5 (7.38)	35 (25.8)	13.5	368	52.4	4200	9000	<b>1PH8103-1 F1 - ■■■■2</b>
132		7 (9.39)	45 (33.2)	17.5	348	51.9	5250	9000	<b>1PH8105-1 F1 - ■■■■2</b>
		9 (12.1)	57 (42.0)	23.5	330	52.2	4500	9000	<b>1PH8107-1 F1 - ■■■■2</b>
		11 (14.8)	70 (51.6)	24	360	51.4	4800	8000	<b>1PH8131-1 F1 - ■■■■2</b>
		15 (20.1)	96 (70.8)	34	342	51.3	5500	8000	<b>1PH8133-1 F1 - ■■■■2</b>
160		18.5 (24.8)	118 (87.0)	43	330	51.3	6150	8000	<b>1PH8135-1 F1 - ■■■■2</b>
		22 (29.5)	140 (103)	56	308	51.3	4300	8000	<b>1PH8137-1 F1 - ■■■■2</b>
		30 (40.2)	191 (141)	71	319	50.8	3500	6500	<b>1PH8163-1 F1 - ■■■■2</b>
		37 (49.6)	236 (174)	78	350	50.8	2800	6500	<b>1PH8165-1 F1 - ■■■■2</b>
<b>1PH8 for line voltage 480 V 3 AC – Forced ventilation NDE → DE</b>									
<b>600</b>	160	14.5 (19.4)	231 (170)	30	370	21	2150	6500	<b>1PH8163-1 B1 - ■■■■2</b>
		19 (25.5)	302 (223)	35	420	20.8	1800	6500	<b>1PH8165-1 B1 - ■■■■2</b>
<b>1350</b>	100	4.7 (6.30)	33 (24.3)	9.7	423	47.3	3500	9000	<b>1PH8103-1 D1 - ■■■■2</b>
		8 (10.7)	57 (42.0)	17	400	47.1	5045	9000	<b>1PH8107-1 D1 - ■■■■2</b>
	132	10.6 (14.2)	75 (55.3)	20	416	46.5	3000	8000	<b>1PH8131-1 D1 - ■■■■2</b>
		15 (20.1)	106 (78.2)	28	417	46.5	3500	8000	<b>1PH8133-1 D1 - ■■■■2</b>
		22 (29.5)	156 (115)	42	404	46.4	4000	8000	<b>1PH8137-1 D1 - ■■■■2</b>
	160	28 (37.5)	198 (146)	52	400	45.8	4000	6500	<b>1PH8163-1 D1 - ■■■■2</b>
		34 (45.6)	241 (178)	66	387	45.8	5600	6500	<b>1PH8165-1 D1 - ■■■■2</b>
	<b>2000</b>	80	3.7 (4.96)	18 (13.3)	7.6	447	70	5550	10000
4.9 (6.57)			23 (17.0)	10	435	69.9	6100	10000	<b>1PH8087-1 F1 - ■■■■2</b>
100		4.7 (6.30)	22 (16.2)	12.5	343	69	7500	9000	<b>1PH8101-1 F1 - ■■■■2</b>
		7 (9.39)	33 (24.3)	12.7	460	69.1	4100	9000	<b>1PH8103-1 F1 - ■■■■2</b>
132		9 (12.1)	43 (31.7)	17	453	68.5	6180	9000	<b>1PH8105-1 F1 - ■■■■2</b>
		11 (14.8)	53 (39.1)	21.5	428	68.6	5500	9000	<b>1PH8107-1 F1 - ■■■■2</b>
		15 (20.1)	72 (53.1)	24	460	68.2	5300	8000	<b>1PH8131-1 F1 - ■■■■2</b>
160		20 (26.8)	96 (70.8)	34	445	68	6200	8000	<b>1PH8133-1 F1 - ■■■■2</b>
		24 (32.2)	115 (84.8)	43	434	67.9	7100	8000	<b>1PH8135-1 F1 - ■■■■2</b>
		28 (37.5)	134 (98.8)	55	401	67.9	4000	8000	<b>1PH8137-1 F1 - ■■■■2</b>
		37 (49.6)	177 (131)	68	416	67.4	3550	6500	<b>1PH8163-1 F1 - ■■■■2</b>
		45 (60.3)	215 (159)	75	440	67.5	3300	6500	<b>1PH8165-1 F1 - ■■■■2</b>

For versions, see  
Article No. supplements.



## SIMOTICS motors and SIMOGEAR geared motors

### SIMOTICS M-1PH8 main motors for SINAMICS S110/SINAMICS S120

#### SIMOTICS M-1PH8 asynchronous motors – Forced ventilation, IP55 degree of protection

Motor type (repeated)	Power factor	Magnetizing current	Efficiency	Moment of inertia without holding brake	Weight without holding brake, approx.	Terminal box	For SINAMICS S110/SINAMICS S120	
							Rated output current <sup>3)</sup>	PM240-2 Power Module Internal air cooling For further components, see SINAMICS S110/ SINAMICS S120 drive system
	$\cos \varphi$	$I_{\mu}$ A	$\eta$ %	$J$ kgm <sup>2</sup> (lb <sub>r</sub> -in-s <sup>2</sup> )	kg (lb)	Type	$I_N$ A	Article No.
<b>Line voltage 380 ... 480 V 3 AC</b>								
1PH8163-1. B ...	0.91	8.1	82.3	0.216 (1.91)	196 (432)	gk863	32	6SL3210 - 1PE23 - 3 ■ L0
1PH8165-1. B ...	0.86	14.9	82.6	0.232 (2.05)	230 (507)	gk863	38	6SL3210 - 1PE23 - 8 ■ L0
1PH8103-1. D ...	0.82	4.6	81.4	0.0172 (0.15)	51 (112)	gk813	13.2	6SL3210 - 1PE21 - 4 ■ L0
1PH8107-1. D ...	0.82	8.2	83.4	0.0289 (0.26)	73 (161)	gk813	18	6SL3210 - 1PE21 - 8 ■ L0
1PH8131-1. D ...	0.86	8	87	0.059 (0.52)	89 (196)	gk833	32	6SL3210 - 1PE23 - 3 ■ L0
1PH8133-1. D ...	0.88	10.1	87.1	0.076 (0.67)	106 (234)	gk833	32	6SL3210 - 1PE23 - 3 ■ L0
1PH8137-1. D ...	0.88	15.1	88.1	0.109 (0.96)	141 (311)	gk833	45	6SL3210 - 1PE24 - 5 ■ L0
1PH8163-1. D ...	0.89	17.3	90.9	0.216 (1.91)	196 (432)	gk863	60	6SL3210 - 1PE26 - 0 ■ L0
1PH8165-1. D ...	0.89	22.2	91.4	0.232 (2.05)	230 (507)	gk863	75	6SL3210 - 1PE27 - 5 ■ L0
1PH8083-1. F ...	0.80	3.8	80.9	0.0064 (0.06)	32 (70.5)	gk803	10.2	6SL3210 - 1PE21 - 1 ■ L0
1PH8087-1. F ...	0.81	4.9	81.7	0.0089 (0.08)	39 (86.0)	gk803	13.2	6SL3210 - 1PE21 - 4 ■ L0
1PH8101-1. F ...	0.80	6	83.5	0.0138 (0.12)	42 (92.6)	gk813	18	6SL3210 - 1PE21 - 8 ■ L0
1PH8103-1. F ...	0.80	6.5	85.2	0.0172 (0.15)	51 (112)	gk813	18	6SL3210 - 1PE21 - 8 ■ L0
1PH8105-1. F ...	0.79	8.8	86.7	0.0252 (0.22)	65 (143)	gk813	18	6SL3210 - 1PE21 - 8 ■ L0
1PH8107-1. F ...	0.81	10.8	86.9	0.0289 (0.26)	73 (161)	gk813	26	6SL3210 - 1PE22 - 7 ■ L0
1PH8131-1. F ...	0.84	10.4	89.9	0.059 (0.52)	89 (196)	gk833	26	6SL3210 - 1PE22 - 7 ■ L0
1PH8133-1. F ...	0.85	14.2	89.9	0.076 (0.67)	106 (234)	gk833	38	6SL3210 - 1PE23 - 8 ■ L0
1PH8135-1. F ...	0.85	18.1	89.8	0.094 (0.83)	125 (276)	gk833	45	6SL3210 - 1PE24 - 5 ■ L0
1PH8137-1. F ...	0.84	24.2	90.4	0.109 (0.96)	141 (311)	gk833	60	6SL3210 - 1PE26 - 0 ■ L0
1PH8163-1. F ...	0.87	25.6	92.3	0.216 (1.91)	196 (432)	gk863	75	6SL3210 - 1PE27 - 5 ■ L0
1PH8165-1. F ...	0.88	27	92.6	0.232 (2.05)	230 (507)	gk863	90	6SL3210 - 1PE28 - 8 ■ L0
<b>Line voltage 380 ... 480 V 3 AC</b>								
1PH8163-1. B ...	0.90	8.1	85.1	0.216 (1.91)	196 (432)	gk863	32	6SL3210 - 1PE23 - 3 ■ L0
1PH8165-1. B ...	0.88	12	85	0.232 (2.05)	230 (507)	gk863	38	6SL3210 - 1PE23 - 8 ■ L0
1PH8103-1. D ...	0.82	4.4	84.8	0.0172 (0.15)	51 (112)	gk813	13.2	6SL3210 - 1PE21 - 4 ■ L0
1PH8107-1. D ...	0.80	8.2	86.7	0.0289 (0.26)	73 (161)	gk813	18	6SL3210 - 1PE21 - 8 ■ L0
1PH8131-1. D ...	0.86	7.9	90	0.059 (0.52)	89 (196)	gk833	32	6SL3210 - 1PE23 - 3 ■ L0
1PH8133-1. D ...	0.86	10.7	90.4	0.076 (0.67)	106 (234)	gk833	32	6SL3210 - 1PE23 - 3 ■ L0
1PH8137-1. D ...	0.86	15.9	90.2	0.109 (0.96)	141 (311)	gk833	45	6SL3210 - 1PE24 - 5 ■ L0
1PH8163-1. D ...	0.88	17.7	92.4	0.216 (1.91)	196 (432)	gk863	60	6SL3210 - 1PE26 - 0 ■ L0
1PH8165-1. D ...	0.86	22.5	92.8	0.232 (2.05)	230 (507)	gk863	75	6SL3210 - 1PE27 - 5 ■ L0
1PH8083-1. F ...	0.79	3.7	85	0.0064 (0.06)	32 (70.5)	gk803	10.2	6SL3210 - 1PE17 - 1 ■ L0
1PH8087-1. F ...	0.80	4.9	86.4	0.0089 (0.08)	39 (86.0)	gk803	13.2	6SL3210 - 1PE21 - 4 ■ L0
1PH8101-1. F ...	0.79	6	87.1	0.0138 (0.12)	42 (92.6)	gk813	18	6SL3210 - 1PE21 - 8 ■ L0
1PH8103-1. F ...	0.81	5.8	89.4	0.0172 (0.15)	51 (112)	gk813	18	6SL3210 - 1PE21 - 8 ■ L0
1PH8105-1. F ...	0.78	8.7	91.1	0.0252 (0.22)	65 (143)	gk813	18	6SL3210 - 1PE21 - 8 ■ L0
1PH8107-1. F ...	0.79	10.8	90.1	0.0289 (0.26)	73 (161)	gk813	26	6SL3210 - 1PE22 - 7 ■ L0
1PH8131-1. F ...	0.86	9.2	93.1	0.059 (0.52)	89 (196)	gk833	26	6SL3210 - 1PE22 - 7 ■ L0
1PH8133-1. F ...	0.85	13.5	93.3	0.076 (0.67)	106 (234)	gk833	38	6SL3210 - 1PE23 - 8 ■ L0
1PH8135-1. F ...	0.84	18.1	92.9	0.094 (0.83)	125 (276)	gk833	45	6SL3210 - 1PE24 - 5 ■ L0
1PH8137-1. F ...	0.84	23.1	93.1	0.109 (0.96)	141 (311)	gk833	60	6SL3210 - 1PE26 - 0 ■ L0
1PH8163-1. F ...	0.86	24.6	93.2	0.216 (1.91)	196 (432)	gk863	75	6SL3210 - 1PE27 - 5 ■ L0
1PH8165-1. F ...	0.89	23.6	93.6	0.232 (2.05)	230 (507)	gk863	90	6SL3210 - 1PE28 - 8 ■ L0

**Line filter:**  
Without  
Integrated

**U**  
**A**

<sup>1)</sup>  $n_2$ : Maximum permissible thermal speed at constant power or speed, which is at the voltage limit when  $P = P_N$ .

<sup>2)</sup>  $n_{max}$ : Maximum speed that must not be exceeded (applicable to standard: 14th data position B to C).

<sup>3)</sup> The rated pulse frequencies must be taken into account. The rated motor data is valid for 4 kHz.

## SIMOTICS motors and SIMOGEAR geared motors

SIMOTICS M-1PH8 main motors for SINAMICS S110/SINAMICS S120

## SIMOTICS M-1PH8 asynchronous motors – Water cooling, IP65 degree of protection

## Selection and ordering data

Rated speed	Shaft height	Rated power	Rated torque	Rated current	Rated voltage	Rated frequency	Operating speed during field weakening, max. <sup>1)</sup>	Speed, max. <sup>2)</sup>	SIMOTICS M-1PH8 asynchronous motors
$n_N$ rpm	SH	$P_N$ kW (hp)	$M_N$ Nm (lb <sub>r</sub> -ft)	$I_N$ A	$U_N$ V	$f_N$ Hz	$n_2$ rpm	$n_{max}$ rpm	Article No.
<b>1PH8 for line voltage 400 V 3 AC – Water cooling</b>									
<b>1500</b>	80	3.5 (4.69)	22 (16.2)	8.9	357	54.5	3550	10000	<b>1PH8083-1 F2 - - - - 1</b>
		4.6 (6.17)	29 (21.4)	13.7	316	53.3	6000	10000	<b>1PH8087-1 F2 - - - - 1</b>
100	100	5 (6.71)	32 (23.6)	12.8	357	53.1	2500	9000	<b>1PH8101-1 F2 - - - - 1</b>
		7.1 (9.52)	45 (33.2)	19.7	317	53	4000	9000	<b>1PH8103-1 F2 - - - - 1</b>
		11 (14.8)	70 (51.6)	28.5	340	52.8	3500	9000	<b>1PH8105-1 F2 - - - - 1</b>
		14 (18.8)	89 (65.6)	43.7	277	53.3	5600	9000	<b>1PH8107-1 F2 - - - - 1</b>
		15 (20.1)	96 (70.8)	30	380	52.3	2500	8000	<b>1PH8131-1 F2 - - - - 1</b>
132	132	17 (22.8)	108 (79.7)	38	345	51.5	3500	8000	<b>1PH8133-1 F2 - - - - 1</b>
		22 (29.5)	140 (103)	51	342	51.5	4000	8000	<b>1PH8135-1 F2 - - - - 1</b>
		27 (36.2)	172 (127)	67	315	51.6	4000	8000	<b>1PH8137-1 F2 - - - - 1</b>
		30 (40.2)	191 (141)	80	289	51.9	5000	8000	<b>1PH8138-1 F2 - - - - 1</b>
160	160	37 (49.6)	236 (174)	84	328	51.1	3000	6500	<b>1PH8163-1 F2 - - - - 1</b>
		46 (61.7)	293 (216)	104	330	50.9	3050	6500	<b>1PH8165-1 F2 - - - - 1</b>
		52 (69.7)	331 (244)	116	332	51.2	3050	6500	<b>1PH8166-1 F2 - - - - 1</b>
<b>1PH8 for line voltage 480 V 3 AC – Water cooling</b>									
<b>2000</b>	80	4.6 (6.17)	22 (16.2)	8.7	457	71	4250	10000	<b>1PH8083-1 F2 - - - - 1</b>
		6.1 (8.18)	29 (21.4)	13.7	402	70	6950	10000	<b>1PH8087-1 F2 - - - - 1</b>
100	100	6.6 (8.85)	32 (23.6)	12.5	450	69.9	2500	9000	<b>1PH8101-1 F2 - - - - 1</b>
		9.4 (12.6)	45 (33.2)	19.7	411	69.7	5000	9000	<b>1PH8103-1 F2 - - - - 1</b>
		14 (18.8)	67 (49.4)	27.5	426	69.5	3000	9000	<b>1PH8105-1 F2 - - - - 1</b>
		18 (24.1)	86 (63.4)	42.6	363	69.7	3000	9000	<b>1PH8107-1 F2 - - - - 1</b>
		18.5 (24.8)	88 (64.9)	30	460	68.7	2500	8000	<b>1PH8131-1 F2 - - - - 1</b>
132	132	22.5 (30.2)	107 (78.9)	38	452	68.2	4000	8000	<b>1PH8133-1 F2 - - - - 1</b>
		29 (38.9)	138 (102)	52	448	68.2	4500	8000	<b>1PH8135-1 F2 - - - - 1</b>
		36 (48.3)	172 (127)	67	415	68.3	4000	8000	<b>1PH8137-1 F2 - - - - 1</b>
		37 (49.6)	177 (131)	76	380	68.4	6000	8000	<b>1PH8138-1 F2 - - - - 1</b>
160	160	49 (65.7)	234 (173)	84	430	67.7	3500	6500	<b>1PH8163-1 F2 - - - - 1</b>
		60 (80.5)	287 (212)	103	426	67.6	3050	6500	<b>1PH8165-1 F2 - - - - 1</b>
		68 (91.2)	325 (240)	116	426	67.9	3050	6500	<b>1PH8166-1 F2 - - - - 1</b>

For versions, see Article No. supplements

## SIMOTICS motors and SIMOGEAR geared motors

### SIMOTICS M-1PH8 main motors for SINAMICS S110/SINAMICS S120

#### SIMOTICS M-1PH8 asynchronous motors – Water cooling, IP65 degree of protection

Motor type (repeated)	Power factor	Magnetizing current	Efficiency	Moment of inertia	Weight, approx.	Terminal box	For SINAMICS S110/SINAMICS S120	
	$\cos \varphi$	$I_{\mu}$ A	$\eta$ %	$J$ kgm <sup>2</sup> (lb <sub>r</sub> -in-s <sup>2</sup> )	kg (lb)	Type	Rated output current <sup>3)</sup> $I_N$ A	<b>PM240-2 Power Module</b> <b>Internal air cooling</b> For further components, see SINAMICS S110/ SINAMICS S120 drive system  Article No.
							Line voltage 380 ... 480 V 3 AC	
1PH8083-1. F....	0.84	3.6	78.4	0.0064 (0.06)	36 (79.4)	gk803	13.2	6SL3210 - 1PE21 - 4 █ L0
1PH8087-1. F....	0.78	7.2	81.4	0.0089 (0.08)	44 (97.0)	gk803	18	6SL3210 - 1PE21 - 8 █ L0
1PH8101-1. F....	0.81	6	81.3	0.0138 (0.12)	51 (112)	gk823	18	6SL3210 - 1PE21 - 8 █ L0
1PH8103-1. F....	0.82	8.6	82.7	0.0172 (0.15)	60 (132)	gk823	26	6SL3210 - 1PE22 - 7 █ L0
1PH8105-1. F....	0.81	13.3	84.3	0.0252 (0.22)	74 (163)	gk823	32	6SL3210 - 1PE23 - 3 █ L0
1PH8107-1. F....	0.83	17.8	82.9	0.0289 (0.26)	83 (183)	gk823	45	6SL3210 - 1PE24 - 5 █ L0
1PH8131-1. F....	0.89	9.2	88.3	0.059 (0.52)	105 (231)	gk843	32	6SL3210 - 1PE23 - 3 █ L0
1PH8133-1. F....	0.86	14.2	89.7	0.076 (0.67)	123 (271)	gk843	38	6SL3210 - 1PE23 - 8 █ L0
1PH8135-1. F....	0.85	20.3	90.1	0.094 (0.83)	141 (311)	gk843	60	6SL3210 - 1PE26 - 0 █ L0
1PH8137-1. F....	0.86	25.3	90	0.109 (0.96)	157 (346)	gk843	75	6SL3210 - 1PE27 - 5 █ L0
1PH8138-1. F....	0.88	27.1	88.2	0.109 (0.96)	157 (346)	gk843	75	6SL3210 - 1PE27 - 5 █ L0
1PH8163-1. F....	0.88	27.4	91.6	0.216 (1.91)	229 (505)	gk873	90	6SL3210 - 1PE28 - 8 █ L0
1PH8165-1. F....	0.87	37.2	93	0.232 (2.05)	264 (582)	gk873	110	6SL3210 - 1PE31 - 1 █ L0
1PH8166-1. F....	0.88	36.7	93.6	0.232 (2.05)	269 (593)	gk873	145	6SL3210 - 1PE31 - 5 █ L0
							Line voltage 380 ... 480 V 3 AC	
1PH8083-1. F....	0.83	3.8	83.9	0.0064 (0.06)	36 (79.4)	gk803	13.2	6SL3210 - 1PE21 - 4 █ L0
1PH8087-1. F....	0.79	6.8	86.8	0.0089 (0.08)	44 (97.0)	gk803	18	6SL3210 - 1PE21 - 8 █ L0
1PH8101-1. F....	0.82	4.4	85.8	0.0138 (0.12)	51 (112)	gk823	18	6SL3210 - 1PE21 - 8 █ L0
1PH8103-1. F....	0.82	8.5	86.9	0.0172 (0.15)	60 (132)	gk823	26	6SL3210 - 1PE22 - 7 █ L0
1PH8105-1. F....	0.82	11.7	89.4	0.0252 (0.22)	74 (163)	gk823	32	6SL3210 - 1PE23 - 3 █ L0
1PH8107-1. F....	0.81	19.1	87.3	0.0289 (0.26)	83 (183)	gk823	45	6SL3210 - 1PE24 - 5 █ L0
1PH8131-1. F....	0.90	7.2	91.2	0.059 (0.52)	105 (231)	gk843	32	6SL3210 - 1PE23 - 3 █ L0
1PH8133-1. F....	0.86	14.4	93.8	0.076 (0.67)	123 (271)	gk843	38	6SL3210 - 1PE23 - 8 █ L0
1PH8135-1. F....	0.85	19.9	93.1	0.094 (0.83)	141 (311)	gk843	60	6SL3210 - 1PE26 - 0 █ L0
1PH8137-1. F....	0.86	25.4	92.8	0.109 (0.96)	157 (346)	gk843	75	6SL3210 - 1PE27 - 5 █ L0
1PH8138-1. F....	0.86	28.4	92	0.109 (0.96)	157 (346)	gk843	75	6SL3210 - 1PE27 - 5 █ L0
1PH8163-1. F....	0.88	26.9	92.5	0.216 (1.91)	229 (505)	gk873	90	6SL3210 - 1PE28 - 8 █ L0
1PH8165-1. F....	0.88	34	94	0.232 (2.05)	264 (582)	gk873	110	6SL3210 - 1PE31 - 1 █ L0
1PH8166-1. F....	0.89	32.8	94.1	0.232 (2.05)	269 (593)	gk873	145	6SL3210 - 1PE31 - 5 █ L0

**Line filter:**  
Without  
Integrated

**U  
A**

<sup>1)</sup>  $n_2$ : Maximum permissible thermal speed at constant power.

<sup>2)</sup>  $n_{max}$ : Maximum speed that must not be exceeded (applicable to standard: 14th data position B to C).

<sup>3)</sup> The rated pulse frequencies must be taken into account. The rated motor data is valid for 4 kHz.

**SIMOTICS motors and SIMOGEAR geared motors**

SIMOTICS M-1PH8 main motors for SINAMICS S110/SINAMICS S120

**Article No. supplements for SIMOTICS M-1PH8 without holding brake > SH 80 to SH 160****Selection and ordering data**

Data position in Article No.	1	2	3	4	5	6	7	8	9	10	11	12	13	14	15	16				
<b>Shaft height 80</b>	1	P	H	8	0	8	.	-	■	■	■	■	■	-	■	■	■	.	-	Z
<b>Shaft height 100</b>	1	P	H	8	1	0	.	-	■	■	■	■	■	-	■	■	■	.	-	Z
<b>Shaft height 132</b>	1	P	H	8	1	3	.	-	■	■	■	■	■	-	■	■	■	.	-	Z
<b>Shaft height 160</b>	1	P	H	8	1	6	.	-	■	■	■	■	■	-	■	■	■	.	-	Z
<b>Overall length</b> (cannot be selected, determined by the choice of rated power)	.																			
<b>Asynchronous version</b>	1																			
<b>Encoder systems for motors <u>without</u> DRIVE-CLiQ interface</b>																				
Without encoder <sup>1)</sup>																				2
Absolute encoder EnDat 2048 S/R (encoder AM2048S/R) <sup>2)</sup>																				2
Incremental encoder HTL 1024 S/R (encoder HTL1024S/R) <sup>1) 3)</sup>																				2
Incremental encoder HTL 2048 S/R (encoder HTL2048S/R) <sup>1) 4)</sup>																				2
Incremental encoder HTL 1024 S/R (encoder HTL1024S/R) with connection via additional terminal box <sup>1) 3) 10)</sup>																				2
Incremental encoder HTL 2048 S/R (encoder HTL2048S/R) with connection via additional terminal box <sup>1) 4) 10)</sup>																				2
Incremental encoder sin/cos 1 V <sub>pp</sub> 2048 S/R with C and D tracks (encoder IC2048S/R) <sup>2)</sup>																				2
Incremental encoder sin/cos 1 V <sub>pp</sub> 512 S/R without C and D tracks (encoder IN512S/R) <sup>1) 5)</sup>																				2
<b>Encoder systems for motors <u>with</u> DRIVE-CLiQ interface</b>																				
Absolute encoder 22-bit single-turn + 12-bit multi-turn (encoder AM22DQ) <sup>2)</sup>																				1
Incremental encoder 22-bit with commutation position (encoder IC22DQ) <sup>2)</sup>																				1
Incremental encoder 20-bit without commutation position (encoder IN20DQ) <sup>1) 5)</sup>																				1
<b>Rated speeds (380 V to 480 V 3 AC)</b> (winding design)																				
400 rpm, 500 rpm, 600 rpm, 700 rpm																				B
1000 rpm, 1150 rpm, 1350 rpm, 1500 rpm																				D
1500 rpm, 1750 rpm, 2000 rpm, 2200 rpm																				F
2000 rpm, 2300 rpm, 2650 rpm, 2800 rpm																				G
2500 rpm, 2800 rpm, 3000 rpm																				L
3000 rpm, 3300 rpm, 3600 rpm, 3900 rpm																				M
<b>Cooling</b>																				
<b>Degree of protection</b>																				
Forced ventilation DE → NDE																				0
Forced ventilation NDE → DE																				1
Water cooling																				2
<b>Type of construction</b>																				
IM B3 (IM V5, IM V6, IM B6, IM B7, IM B8)																				0
IM B5 (IM V1, IM V3) <sup>12)</sup>																				2
IM B35 (IM V15, IM V35) <sup>6)</sup>																				3
<b>Version status</b> <sup>11)</sup>																				
<b>Special version</b> (order codes required for options)																				Z

See next page for the 13th to 16th digit of the Article No.

**Ordering example**

Selection criteria	Version	Structure of the Article No.
<b>1PH8 motor</b>	Asynchronous version, water cooling Shaft height 132 Version status 1	<b>1PH8131-1 . . . 2 . . . . 1</b>
Encoder system	Incremental encoder HTL 1024 S/R (encoder HTL1024S/R)	<b>1PH8131-1H . 2 . . . . 1</b>
Rated operating point	1500 rpm, 15 kW (20.1 hp), 96 Nm (70.8 lb <sub>f</sub> -ft)	<b>1PH8131-1HF2 . . . . 1</b>
Type of construction	IM B3 (IM V5, IM V6)	<b>1PH8131-1HF20 . . . . 1</b>
Shaft extension DE	Plain shaft	<b>1PH8131-1HF20-0 . . 1</b>
Bearing version	Standard Vibration severity R/A Shaft and flange accuracy R	<b>1PH8131-1HF20-0B . 1</b>
Connection	Cable connection terminal box top Cable entry on the right, signal connection DE	<b>1PH8131-1HF20-0BA1</b>

# SIMOTICS motors and SIMOGEAR geared motors

## SIMOTICS M-1PH8 main motors for SINAMICS S110/SINAMICS S120

Article No. supplements for SIMOTICS M-1PH8 without holding brake > SH 80 to SH 160

### Selection and ordering data

Data position in Article No.	1	2	3	4	5	6	7	8	9	10	11	12	13	14	15	16	
	1	P	H	8	.	.	.	-	■	■	■	■	-	■	■	■	Z
<b>Shaft extension (DE)</b>	<b>Balancing</b>																
Plain shaft	-													0			
Feather key	Full-key													1			
Feather key	Half-key													2			
<b>Bearing</b>	<b>Vibration severity acc. to Siemens/EN 60034-14</b>												<b>Shaft and flange accuracy</b>				
Standard with location bearing <sup>13)</sup>	R/A												R		B		
Standard with location bearing <sup>13)</sup>	S/A												R		C		
Standard with location bearing <sup>1) 13)</sup>	SR/A												R		D		
Standard <sup>13)</sup>	R/A												R		G		
Standard <sup>13)</sup>	S/A												R		H		
Increased radial forces <sup>13) 15)</sup>	R/A												R		F		
Performance <sup>7)</sup>	SPECIAL/B												SPECIAL		L		
Advanced Lifetime <sup>8) 13)</sup>	S/A												R		Q		
<b>Power connection (looking at DE)</b>																	
<u>Terminal box</u>			<u>Cable entry</u>				<u>Signal connection</u>										
Top			Right				DE						A				
Top			Left				DE						B				
Top			NDE				Left						C				
Top <sup>14)</sup>			DE				Left						D				
<u>Power connector</u>																	
Top <sup>9)</sup>			Right				DE						E				
Top <sup>9)</sup>			Left				DE						F				
Top <sup>9)</sup>			NDE				Left						G				
Top <sup>9)</sup>			DE				Left						H				
<b>Version status <sup>11)</sup></b>																	
<b>Special version (order codes required for options)</b>																Z	

<sup>1)</sup> Only possible when 8th data position is: 1 (asynchronous version).

<sup>2)</sup> Limited to  $n_{\max} = 12000$  rpm.

<sup>3)</sup> Limited to  $n_{\max} = 9000$  rpm.

<sup>4)</sup> Limited to  $n_{\max} = 4600$  rpm.

<sup>5)</sup> Limited to  $n_{\max} = 15000$  rpm.

<sup>6)</sup> Only possible for shaft height 100, 132, and 160.

<sup>7)</sup> Only possible when 8th data position is: 1 (asynchronous version).

Shaft height 80: limited to  $n_{\max} = 15000$  rpm,

Shaft height 100: limited to  $n_{\max} = 12000$  rpm,

Shaft height 132: limited to  $n_{\max} = 10000$  rpm,

Shaft height 160: limited to  $n_{\max} = 9000$  rpm; not possible when 12th data position is: 2 (IM B5).

<sup>8)</sup> Limited to  $n_{\max} = 5000$  rpm, shaft height 132:  $n_{\max} = 4500$  rpm, shaft height 160:  $n_{\max} = 4000$  rpm.

<sup>9)</sup> At a shaft height of 100, a power connector is only possible up to a maximum stall current of  $I_0 = 36$  A, At a shaft height of 132, a power connector is only possible up to a maximum stall current of  $I_0 = 85$  A, A power connector is not possible for shaft height 160.

<sup>10)</sup> Only possible when 14th data position is: B, C, D, G, H, Q, F, and 15th data position is: A and B.

<sup>11)</sup> Directly coupled to 9th data position.

<sup>12)</sup> Not possible with shaft height 160 and 14th data position: L.

<sup>13)</sup> Not possible when 9th data position is: T, U.

<sup>14)</sup> Not possible with shaft height 160 and 8th data position is: 2 or 4 (synchronous version).

<sup>15)</sup> Limited to shaft height 100:  $n_{\max} = 7000$  rpm, shaft height 132:  $n_{\max} = 6500$  rpm, shaft height 160:  $n_{\max} = 5300$  rpm.

## SIMOTICS motors and SIMOGEAR geared motors

Mechatronics components

### Electric cylinders

#### Overview



Axial mounting of a SIMOTICS S-1FK7 motor on the linear unit with mounting kit and accessories

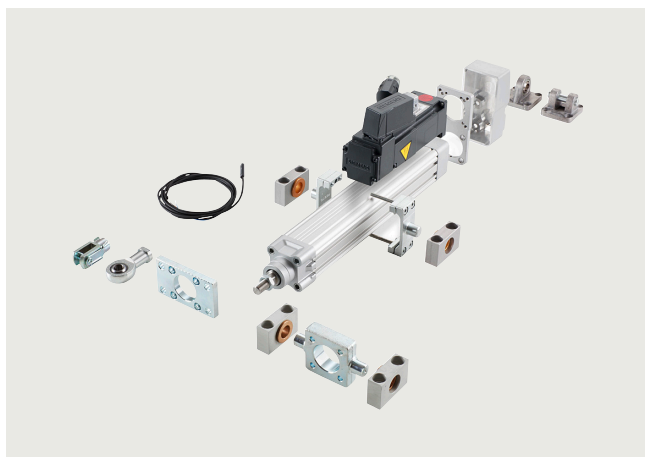

Parallel mounting of a SIMOTICS S-1FK7 motor on the linear unit with mounting kit and accessories

The electric cylinder consists of a CASM linear unit from EWELLIX and a SIMOTICS S-1FK7 motor. The CASM linear unit converts the rotary motion of the SIMOTICS S-1FK7 motor into a highly dynamic linear movement and is a perfect substitute for pneumatic or hydraulic cylinders in many applications. By contrast with pneumatic and hydraulic cylinders, electric cylinders allow the driven machine to approach any position with extreme precision solely on the basis of setpoints transferred to a converter from the SINAMICS S110 or SINAMICS S120 range.

#### Benefits

- Modular system with wide variety of options.
- Substitute for hydraulic and pneumatic cylinders in most applications.
- No compressed air/hydraulic fluid required – helps to cut costs (no need to supply compressed air or hydraulic fluid), reduces noise emissions significantly and lowers energy consumption during operation.
- Highly dynamic, precise positioning with high repeat accuracy.
- Mechanical conversion is simple because electric cylinders are essentially the same size as pneumatic cylinders. Furthermore, the relevant pneumatic cylinder accessories can also be used for electric cylinders.
- The SIMOTICS S-1FK7 motors are attached to the linear unit by means of adapters also supplied by EWELLIX, making it very easy for the customer to install the motor.

#### Application

The electric cylinders (CASM linear unit from EWELLIX in conjunction with SIMOTICS S-1FK7 motors and SINAMICS S110/SINAMICS S120 converters) are used wherever a linear movement and/or a defined force is required. Their areas of application are the same as those for pneumatic and hydraulic cylinders.

The electric cylinders are used, for example, in production machines such as:

- Machines used in the wood, glass, and ceramics industries
- Metalworking and coating machines
- Printing machines
- Plastics processing machines
- Packaging machines

Function examples:

- Positioning of cutters
- Edge guidance/edge cutting
- Retainers
- Buffers/sorters/slide gates
- Nozzle holders

Notes:

- Technical advice must be sought for applications involving continuous short-stroke movements (less than three times screw pitch).
- The electric cylinder must be assembled (depending on the stroke length) in such a way as to minimize lateral forces.
- The electric cylinder is not self-locking – it might be necessary to provide a motor holding brake.

#### Design

Electric cylinders essentially comprise the CASM linear unit (with a lead screw or ball screw) housed in an extruded casing and a SIMOTICS S-1FK7 servomotor attached to the linear unit by means of an adapter kit.

The motor can be mounted on the linear unit in two different ways:

- Axial mounting – see first picture:  
Motor is attached using an axial adapter kit (containing all the necessary parts including the coupling)
- Parallel mounting – see second picture:  
Motor is attached using a parallel adapter kit (containing all the necessary parts including timing pulley and toothed belt).

Depending on the linear unit and SIMOTICS S-1FK7 motor used, higher forces can be obtained with the axial arrangement option than with the parallel arrangement driven by a toothed belt.

### Design

The SIMOTICS S-1FK7 motor is normally attached to the linear unit by the user by means of the appropriate adapter. The adapter kit is included in the scope of supply of the linear unit.

### Technical specifications

The technical specifications given below are intended to provide an initial overview only and refer to operation of the linear units with SIMOTICS S-1FK7 motors (see equipment combinations in the tables).

#### CASM-32 linear unit

	Suitable motor type	CASM-32-		
		LS	BS	BN
<b>Spindle type</b>	–	Lead screw	Ball screw	Ball screw
<b>Screw pitch</b>	–	1.5 mm/rev (0.06 in/rev)	3 mm/rev (0.12 in/rev)	10 mm/rev (0.39 in/rev)
<b>Max. force <math>F_{max}</math></b>				
Parallel arrangement	1FK7015	300 N (67.4 lb <sub>f</sub> )	700 N (157 lb <sub>f</sub> )	523 N (118 lb <sub>f</sub> )
Axial arrangement	1FK7015	300 N (67.4 lb <sub>f</sub> )	700 N (157 lb <sub>f</sub> )	528 N (119 lb <sub>f</sub> )
	1FK7022	–	700 N (157 lb <sub>f</sub> )	630 N (142 lb <sub>f</sub> )
<b>Max. average force <math>F_m</math></b> (average force over a completed motion cycle)				
Parallel arrangement	1FK7015	700 N (157 lb <sub>f</sub> )	700 N (157 lb <sub>f</sub> )	151 N (34.0 lb <sub>f</sub> )
Axial arrangement	1FK7015	700 N (157 lb <sub>f</sub> )	700 N (157 lb <sub>f</sub> )	151 N (34.0 lb <sub>f</sub> )
	1FK7022	–	279 N (62.7 lb <sub>f</sub> )	357 N (80.3 lb <sub>f</sub> )
<b>Max. velocity</b>	–	60 mm/s (2.36 in/s)	150 mm/s (5.91 in/s)	500 mm/s (19.7 in/s)
<b>Stroke</b>	–	50 ... 400 mm (1.97 ... 15.7 in)		

#### CASM-40 linear unit

	Suitable motor type	CASM-40-		
		LS	BS	BN
<b>Spindle type</b>	–	Lead screw	Ball screw	Ball screw
<b>Screw pitch</b>	–	2.5 mm/rev (0.1 in/rev)	5 mm/rev (0.2 in/rev)	12.7 mm/rev (0.5 in/rev)
<b>Max. force <math>F_{max}</math></b>				
Parallel arrangement	1FK7022	600 N (135 lb <sub>f</sub> )	2375 N (534 lb <sub>f</sub> )	1276 N (287 lb <sub>f</sub> )
	1FK7034	–	2375 N (534 lb <sub>f</sub> )	1276 N (287 lb <sub>f</sub> )
Axial arrangement	1FK7022	600 N (135 lb <sub>f</sub> )	2375 N (534 lb <sub>f</sub> )	1318 N (296 lb <sub>f</sub> )
	1FK7034	–	2375 N (534 lb <sub>f</sub> )	1550 N (348 lb <sub>f</sub> )
<b>Max. average force <math>F_m</math></b> (average force over a completed motion cycle)				
Parallel arrangement	1FK7022	–	1478 N (332 lb <sub>f</sub> )	575 N (129 lb <sub>f</sub> )
	1FK7034	–	2375 N (534 lb <sub>f</sub> )	1093 N (246 lb <sub>f</sub> )
Axial arrangement	1FK7022	–	1478 N (332 lb <sub>f</sub> )	575 N (129 lb <sub>f</sub> )
	1FK7034	–	2375 N (534 lb <sub>f</sub> )	1093 N (246 lb <sub>f</sub> )
<b>Max. velocity</b>	–	70 mm/s (2.76 in/s)	300 mm/s (11.8 in/s)	826 mm/s (32.52 in/s)
<b>Stroke</b>	–	100 ... 600 mm (3.94 ... 23.6 in)		

### Technical specifications

#### CASM-63 linear unit

	Suitable motor type	CASM-63-		
		LS	BS	BN
<b>Spindle type</b>	–	Lead screw	Ball screw	Ball screw
<b>Screw pitch</b>	–	4 mm/rev (0.16 in/rev)	5 mm/rev (0.2 in/rev)	10 mm/rev (0.39 in/rev)
<b>Max. force <math>F_{max}</math></b>				
Parallel arrangement	1FK7034	1000 N (225 lb <sub>f</sub> )	5400 N (1214 lb <sub>f</sub> )	1339 N (301 lb <sub>f</sub> )
Axial arrangement	1FK7034	1000 N (225 lb <sub>f</sub> )	5400 N (1214 lb <sub>f</sub> )	1583 N (356 lb <sub>f</sub> )
	1FK7044	–	5400 N (1214 lb <sub>f</sub> )	2800 N (629 lb <sub>f</sub> )
<b>Max. average force <math>F_m</math></b> (average force over a completed motion cycle)				
Parallel arrangement	1FK7034	–	2400 N (540 lb <sub>f</sub> )	1404 N (316 lb <sub>f</sub> )
Axial arrangement	1FK7034	–	2400 N (540 lb <sub>f</sub> )	367 N (82.5 lb <sub>f</sub> )
	1FK7044	–	5150 N (1158 lb <sub>f</sub> )	905 N (203 lb <sub>f</sub> )
<b>Max. velocity</b>	–	70 mm/s (2.76 in/s)	300 mm/s (11.8 in/s)	533 mm/s (20.98 in/s)
<b>Stroke</b>	–	100 ... 800 mm (3.94 ... 31.5 in)		

### More information

More information on CASM linear units and adapters, such as technical specifications and selection and ordering data, can be found on the internet at:  
<https://support.industry.siemens.com/cs/document/109744083>

## SIMOTICS motors and SIMOGEAR geared motors

### Notes





### SINAMICS SELECTOR app Mobile selection guide for frequency converters

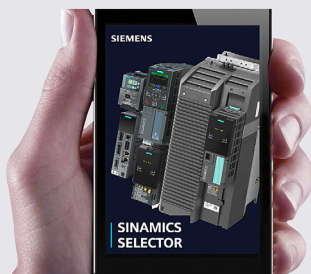

Siemens has developed the SINAMICS SELECTOR app as a practical tool for finding article numbers for your SINAMICS drives in the power range from 0.12 kW to 630 kW quickly and easily. Whether for SINAMICS V20, SINAMICS V90, SINAMICS G120C, SINAMICS G120P or SINAMICS G120: The app will provide you with the correct article numbers conveniently.

How does it work? Simply select your application, the frequency converter you require, the rated power and device options as well as the necessary accessories.

Then you can save your selection and send it by email. The preselection serves as the basis for an order specification with the dealer/Siemens.

You will find the free downloads for Android and for iOS at the following link:

[www.siemens.com/sinamics-selector](http://www.siemens.com/sinamics-selector)

### SINAMICS ASSISTANT app

The error code function of the SINAMICS ASSISTANT app helps you to identify and rectify errors. Just enter the error code of your frequency converter and the app shows you what sort of error it is and how you can rectify it. This app also recalculates for you the frequency (Hz) of a frequency converter into the speed to be set on the motor (rpm) or vice versa.

In addition this app offers you a support page on which you can get in touch straight away with the right contact person in your region if you have any questions. Furthermore, video information is available to you free of charge, e.g. on installation and commissioning of the SINAMICS G120 frequency converter. You will find the free downloads for Android and for iOS at the following link:

[www.siemens.com/sinamics-assistant](http://www.siemens.com/sinamics-assistant)

12/2	<b>SINAMICS DriveSIM Basic</b>
12/4	<b>Siemens Product Configurator</b>
12/5	<b>TIA Selection Tool</b>
12/6	<b>SIMARIS planning tools for systems with SINAMICS drives</b>
12/8	<b>SinaSave energy efficiency tool</b>
12/9	<b>SIZER for Siemens Drives engineering tool (integrated in the TIA Selection Tool)</b>
12/10	<b>STARTER commissioning tool</b>
12/12	<b>SINAMICS Startdrive commissioning tool</b>
12/15	<b>Drive ES engineering software</b>

### Security information

Siemens provides products and solutions with industrial security functions that support the secure operation of plants, systems, machines and networks.

In order to protect plants, systems, machines and networks against cyber threats, it is necessary to implement – and continuously maintain – a holistic, state-of-the-art industrial security concept. Siemens' products and solutions constitute one element of such a concept.

Customers are responsible for preventing unauthorized access to their plants, systems, machines and networks. Such systems, machines and components should only be connected to an enterprise network or the internet if and to the extent such a connection is necessary and only when appropriate security measures (e.g. firewalls and/or network segmentation) are in place.

For additional information on industrial security measures that may be implemented, please visit

[www.siemens.com/industrialsecurity](http://www.siemens.com/industrialsecurity)

Siemens' products and solutions undergo continuous development to make them more secure. Siemens strongly recommends that product updates are applied as soon as they are available and that the latest product versions are used. Use of product versions that are no longer supported, and failure to apply the latest updates may increase customer's exposure to cyber threats.

To stay informed about product updates, subscribe to the Siemens Industrial Security RSS Feed under [www.siemens.com/cert](http://www.siemens.com/cert)

## Digitalization in drive technology

### Virtualization

#### SINAMICS DriveSim Basic

##### Overview

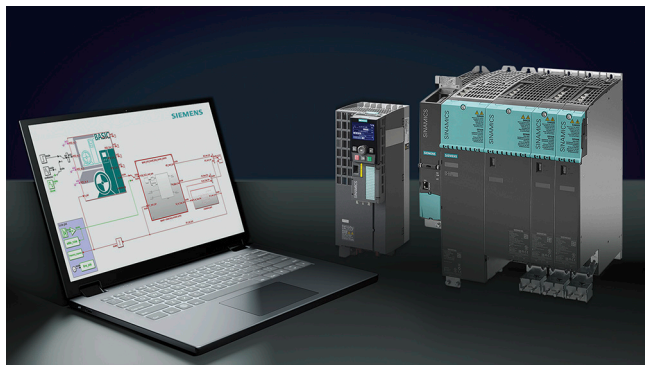

SINAMICS DriveSim Basic provides easy-to-use models for PROFIdrive-enabled SINAMICS converters, so you can create a digital twin of your drive.

The models are validated and tested against real SINAMICS converters and are available in the form of a standardized FMU (Functional Mockup Unit). Therefore, they are compatible with various standard time-based simulation programs such as SIMIT, Simcenter Amesim, ANSYS Twin Builder, MATLAB Simulink or Hopsan.

SINAMICS DriveSim Basic is another element in your engineering toolbox. Together with other virtual Siemens solutions, e.g. SIMATIC S7-PLCSIM Advanced or NX Mechatronics Concept Designer, a consistent model-based development process can be implemented.

##### Benefits

- Speed up time-to-market for OEMs
- Test validated SINAMICS models under real conditions already at the design or planning stage and make needed adjustments
- Identify issues and improvement capabilities early in the design stage and reduce testing effort to save time and cost
- Download is free of charge. The ideal entry point for drive system simulation
- Valid for the most commonly used Siemens drives

##### Advantages of SINAMICS DriveSim Basic compared to SIMIT PROFIdrive blocks:

- Increased level of detail due to speed controller, current setpoint filters and internal load model
- Identical parameter values and meaning as in the real SINAMICS device
- Direct reference to SINAMICS documentation
- Validated against the real SINAMICS drive
- No wiring effort to represent functional configurations
- Significant reduction of SIMIT simulation tags (even more is possible if unused in-/ outputs are deselected within the Component Type Editor (CTE))
- Enables simulation of an (internal) two-mass oscillator as application with realistic SINAMICS parameter settings, besides the known limitations by the minimum sample time in SIMIT
- Compatible with every FMU Co-Simulation 2.0 compatible simulation too

##### Application

With SINAMICS DriveSim Basic, you can implement three major use cases:

- Providing load characteristics for drive selection and dimensioning
- Virtual commission your PLC already in the design phase
- Test and improve interaction between PLC, drives and application virtually

##### Use case 1: Providing load profiles for drive sizing

If you are designing a machine, you want to make sure that you select the SINAMICS converter and SIMOTICS motor most suitable for your drive application. As SINAMICS DriveSim Basic is control-unit-agnostic and thus represents a generic drive, you can parametrize it according to the functionality of your application. Running the simulation results in load characteristics, i.e. torque or speed curves over time. You can import these load profiles into TIA Selection Tool to select the suitable Control Unit and dimension the drive to best fit to the demand. So as a result you have well selected SINAMICS converters and SIMOTICS motors with the help of the digital twin.

##### Use case 2: Virtual commission your PLC already in the design phase

If you are designing a machine, you want to make sure the PLC code works with your SINAMICS drive. After writing the PLC code in TIA Portal, you can connect it via PLCSIM Advanced to any time-based simulation tool (e.g. SIMIT). Integrated into the simulation tool, SINAMICS DriveSim Basic acts as a realistic communication partner for the PLC. Next, you can commission the virtual PLC in TIA Portal as you would do with a real PLC connected to a real drive. Without simulation, you would need to do that on-site. With simulation, you not only save time, but also have the freedom to try out various configurations and optimize your PLC code early in the process.

##### Use case 3: Test and improve interaction between PLC, drives and application virtually

With the third Use case, you can connect a simulation tool such as NX Mechatronic Concept Designer to visualize the mechanical movements of your application. This way, you ensure that the drive behaves according to the desired machine performance. You can test several fault scenarios and optimize the interaction between PLC, application and drive virtually so overall, you can avoid unplanned machine behavior and increase the performance of your setup.

#### Integration

SINAMICS DriveSim Basic can be run in tools that support FMU 2.0 Co-Simulation Import (<https://fmi-standard.org/tools/>).

The FMU has been tested in the following simulation environments and is available in the attached application examples.

Tool	Manufacturer	DriveSimBasic*** variant	PLC Sim Advanced interface	Notes
SIMIT	Siemens	***.fmu	Yes	<ul style="list-style-type: none"> <li>Permissible configuration: ExternalLoad = 1 &amp; . Speed-Controller = 0 or ExternalLoad = 0 &amp; . Speed-Controller = 1</li> <li>Simulation with external load can provide wrong results because the minimum possible time step is 1 ms</li> </ul>
Simcenter Amesim	Siemens	***_double.fmu	Yes	
MATLAB Simulink	MathWorks	< 2019a ***_unstruct.fmu ≥ 2019a ***.fmu	Yes	
ANSYS Twin Builder	ANSYS	***.fmu	No	
Hopsan	Linköping University	***_double.fmu	No	<ul style="list-style-type: none"> <li>Open Source</li> <li>Install "win64-with_compiler-installer.exe" package</li> </ul>

#### Selection and ordering data

Description	Article No.
<b>SINAMICS DriveSim Basic</b>	<b>6FC6490-1SP10-0AB0</b>

#### More information

More information is provided on the internet at: <https://support.industry.siemens.com/cs/document/109798225>

You can find more videos on the topic at:

- [www.youtube.com/watch?v=DN4mxCC6Gm4](http://www.youtube.com/watch?v=DN4mxCC6Gm4)
- <https://youtu.be/GlrUb4Enno>
- <https://youtu.be/JdtfhIGkkYs>
- <https://youtu.be/VKRxyeEssMU>
- <https://youtu.be/VwSEhJMgtrY>
- <https://youtu.be/Q1C9bjiUto>
- <https://youtu.be/yj5SjZe4KkE>

## Engineering tools

### Siemens Product Configurator

#### Overview

The Siemens Product Configurator helps you to configure the optimum drive technology products for a number of applications. The product portfolio comprises the full drive technology range of gearbox, motor, converter and connection system as well as corresponding controller with suitable software license. The intuitive user interface in conjunction with product-specific preliminary selectors makes it simple, fast and efficient to configure products. The result is a bill of materials with extensive documentation consisting of technical data sheets, motor characteristic curves, 2D dimensional drawings / 3D CAD models, EPLAN macros and much more. You can order the products directly by transferring the bill of materials to the shopping cart of the Industry Mall.

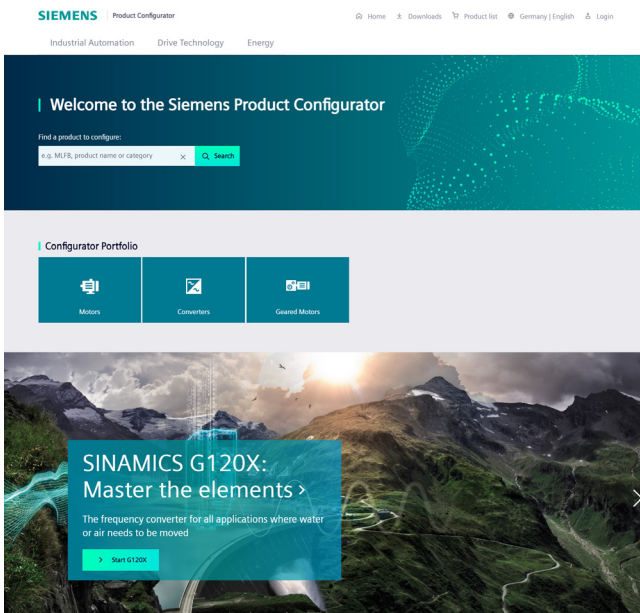

#### Siemens Product Configurator at a glance

- Quick and easy configuration of drive products and associated components – gearboxes, motors, converters, controllers, connection systems
- Extensive documentation for all products and components, such as
  - Data sheets in up to 12 languages
  - Motor characteristic curves
  - 2D dimensional drawings / 3D CAD models in different formats
  - Terminal box drawing and terminal connection diagram
  - Certificates
  - Start-up calculation for SIMOTICS motors
  - EPLAN macros
- Ability to order products directly through the Siemens Industry Mall

#### Access to the Siemens Product Configurator

The Siemens Product Configurator can be accessed without the need for registration or logging in:  
[www.siemens.com/spc](http://www.siemens.com/spc)

## Overview

### Selection guide and configurator for automation technology

Error-free configuration without expert knowledge through intelligent configurators and selection wizards. Desktop and cloud versions enable cross-team collaboration with maximum flexibility.

There are two versions of the TIA Selection Tool:

- for downloading and executing on Microsoft Windows PCs (from Microsoft Windows 10)
- One for running from the cloud, which is launched from mobile devices directly in the browser (we recommend Safari, Chrome and Firefox)

Projects stored in the cloud can be edited with both tools. This makes it possible to work on-the-go using a tablet, at home on a PC – and vice versa, or together with colleagues and customers.

In order to use the full functionality, we recommended setting up a Siemens Industry Mall account for both cases. This gives you access to prices and enables you to save your projects to our cloud.

You can find additional information about the TIA Selection Tool at: [www.siemens.com/tia-selection-tool](http://www.siemens.com/tia-selection-tool)

### Drive dimensioning in the TIA Selection Tool

Application-specific requirements can be determined using drive technology dimensioning in the TIA Selection Tool. This can include motors, gearboxes and converters. The tool supports the configuration and dimensioning of control functions with an open and closed control loop. The technical documentation with features of the technical drive system, as well as a product list for ordering via the Industry Mall can also be compiled.

You can find more information on the SIZER for Siemens Drives engineering tool at

<https://support.industry.siemens.com/cs/ww/en/ps/13434/dl>

## Engineering tools

### SIMARIS planning tools for systems with SINAMICS drives

#### Overview

##### **Electrical planning: Even easier with software!**

Electrical planning for power distribution in non-residential and industrial buildings has never been more complex. To ensure you, as a specialist planner, have the best hand when it comes to electrical planning with SINAMICS drives, we provide support with the following efficient software tools: SIMARIS design for dimensioning and SIMARIS project for calculating the space requirements of the distribution boards.

##### Supported SINAMICS drives:

- SINAMICS G120, SINAMICS G120D, SINAMICS G120X
- SINAMICS G115D
- SINAMICS G130, SINAMICS G150

### SIMARIS planning tools for systems with SINAMICS drives > SIMARIS design

#### Overview

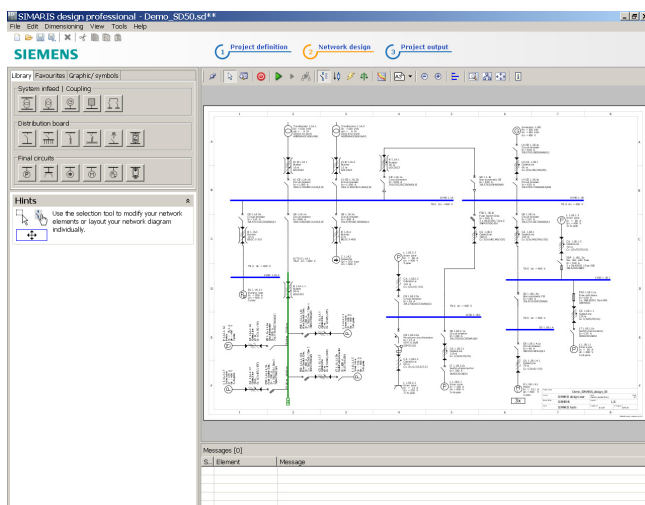

SIMARIS design is a planning tool for quick and effective network calculation and dimensioning of power distribution for non-residential and industrial buildings.

Starting in the planning phase, the entire electrical circuit required for the project can be structured and dimensioned on the basis of real products. For this purpose, the network structure is initially set up based on the stored modules for infeeds, couplings, distributors and branch circuits. It is also possible to reuse stored favorites, such as those processed for previous similar projects. Suitable components and distribution systems are then automatically selected from the product database stored in SIMARIS design based on the selected project-specific parameters and technical data. This precludes the extra costs so often incurred in the implementation phase as a result of systems that have not been correctly coordinated.

Any configuration of electric power distribution is subject to frequent change and adaptation, not only in the planning phase, but also in the implementation phase. SIMARIS design makes it easy to incorporate such changes in the supply concept and to automatically check their reliability in terms of sound engineering practice and the currently applicable standards.

SIMARIS design professional, a program version available for a fee, offers additional useful functions. It can be used to carry out and also document selectivity analyses, essential for safety power supply systems. There is also the option of analyzing and optimizing the energy efficiency of the planned network.

The versatile output variants enable precise documentation of the project structure and of the calculated data suitable for every phase of a project.

There is also the option of exporting the project data. This enables further processing of the planned project in SIMARIS project, and thus also supports and facilitates system planning.

#### Benefits

- Reduction in processing overhead for projects
- Dimensioning of electrical networks on the basis of real products according to sound engineering practice and the currently applicable standards (VDE, IEC)
- Automatic selection of the correct components from medium voltage through to interfacing of the load from the stored product database, i.e. no detailed knowledge of products and systems required
- Open definition of the types of mains operation and switching states
- Calculation of the short circuit current, load flow, voltage drop and energy balance
- Incorporation of the required person, short circuit and over-load protection
- Option of factoring in any necessary functional endurance
- Display and dimensioning of cable and busbar trunking systems for power conveyance and distribution
- High planning reliability coupled with flexibility in the planning and implementation process
- Tracking changes via Change index possible
- Simple adaptation in the case of application changes or expansions
- Option for saving frequently required modules in the Favorites library
- Output of the created network diagram, as well as detailed parts lists and data lists
- Incorporation of country-specific product portfolios
- Comprehensive documentation of planning results with simple data transfer (Office, CAD etc.)

#### Application

SIMARIS design is a software tool for the network calculation and dimensioning of power distribution for non-residential and industrial buildings. Whether for a shopping center, a hospital or production facilities – with SIMARIS design you can reduce the overhead required for the overall planning of power distribution systems and hence the time spent on the selection and dimensioning of equipment.

#### More information

For further information and available downloads, please go to: [www.siemens.com/simarisdg](http://www.siemens.com/simarisdg)

If you have any other questions, please do not hesitate to contact our Customer Support Center:

Phone.: +49 70 00 7 46 27 47

Email: [technical-assistance@siemens.com](mailto:technical-assistance@siemens.com)

## SIMARIS planning tools for systems with SINAMICS drives &gt; SIMARIS project

## Overview

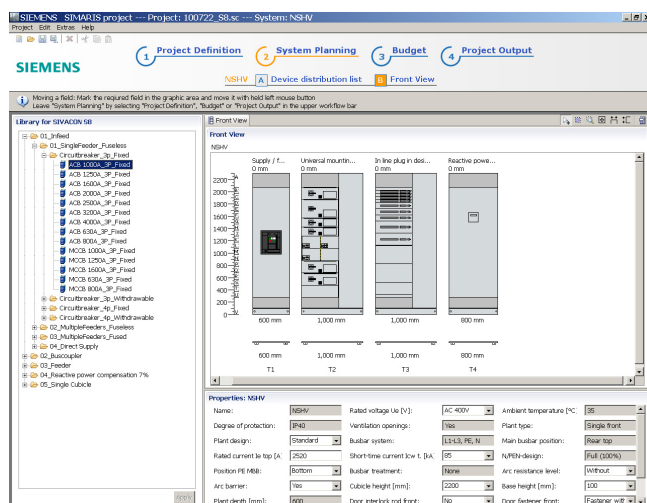

SIMARIS project is a planning tool for fast calculation of space requirements and electrical power distribution system budgets for non-residential and industrial buildings, and for generating specifications automatically.

The following is determined in SIMARIS project based on the pre-defined project structure and the basic technical specifications selected:

- For medium-voltage switchboards: selection of the required system and the required fields, then presentation of a front view with dimensions.
- Following selection of the system for transformers, the required quantity must be selected. Selected transformers are presented as a parts list.
- For low-voltage switchboards and distribution boards: selection of the required protection devices and switching devices per system. The most suitable distribution system is determined automatically based on the list of distribution devices thus created. It is then equipped with the devices and presented graphically in an automatically generated front view that includes dimensions.
- Following selection of the system for busbar trunking systems the length is specified and the additionally required components are selected, e.g. infeeds, junction units and tap-off units. All the resulting components are listed in a parts list.

Detailed information about Siemens devices or their article numbers is not needed because SIMARIS project makes the selection automatically on the basis of the parameters entered. For each item of switchboard or each distribution board, SIMARIS project takes the wiring, control and measurement etc. into account.

A system plan drawn up in SIMARIS design can also be imported into SIMARIS project, which means that selecting devices becomes redundant and SIMARIS project builds up the project structure automatically.

Convenient output versions are available to document the results, including the automatic generation of specifications for the planned systems.

Typical versions of a system planned in SIMARIS project can be saved and repeatedly integrated in new projects from the Favorites library. Automatically created systems can also be subsequently optimized or changed. This is particularly relevant if planning becomes more detailed and the budget needs to be reinforced as a result.

For detailed calculation of costs – on an up-to-date and regional basis – and for more project support, please contact your Siemens representative.

## Benefits

- Intuitive and easy to operate
- Automatic selection and placement of matching distribution systems
- Fast determination of the space requirements and cost of power distribution plants
- End-to-end planning, from medium-voltage switchgear assemblies, transformers, low-voltage switchgear and busbar trunking systems right through to the distribution boards
- Simple adaptation of project planning with increasing clarification of implementation requirements, but also in the event of application changes or expansions
- Saving planned systems for similar projects individually in the favorites library and importing them from there into new projects
- Option of factoring in functional endurance for busbar systems
- Convenient output versions for documentation, such as graphic views, lists and specifications
- Projects created in SIMARIS design can also be imported

## Application

SIMARIS project is suitable for the fast determination of the space requirements and cost of electrical power distribution in all industrial and non-residential buildings and for the automatic generation of specifications. From shopping centers to hospitals and production buildings – with SIMARIS project it is possible to reduce the amount of work required for the overall planning of power distribution systems and hence the time spent on selecting and dimensioning the necessary equipment.

## More information

For further information and available downloads, please go to: [www.siemens.com/simariproject](http://www.siemens.com/simariproject)

If you have any other questions, please do not hesitate to contact our Customer Support Center:  
Phone.: +49 70 00 7 46 27 47  
Email: [technical-assistance@siemens.com](mailto:technical-assistance@siemens.com)

## Engineering tools

### SinaSave energy efficiency tool

#### Overview

SinaSave determines the energy saving potential and payback time based on your application setup. SinaSave is a web tool which is intuitive to operate and supports you in an investment decision:

- Is it worthwhile to use more energy efficient systems?
- When will my investment pay off?

SinaSave supports you to find the optimum solution: technically, economically, and ecologically.

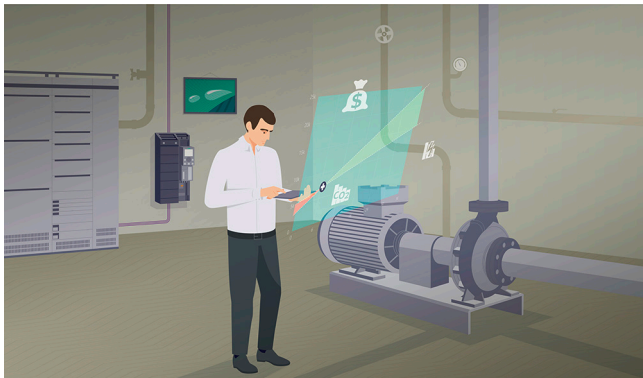

#### In which cases can SinaSave support you?

- Motors
  - Calculate your potential energy savings and amortization times with SIMOTICS motors
- Pump systems
  - Calculate your potential energy and CO<sub>2</sub> savings with our pump drive systems
- Fan systems
  - Calculate your potential energy and CO<sub>2</sub> savings with our fan drive systems

#### Access to the SinaSave energy efficiency tool

SinaSave can be accessed without the need for registration or logging in:

[www.siemens.com/sinasave](http://www.siemens.com/sinasave)

#### Benefits

- **Transparency of overall savings potential and individual amortization plan**
  - SinaSave calculates the expected energy consumption and the resulting savings of energy, CO<sub>2</sub> and energy cost, based on your individual energy prices, operating times and load profiles.
- **Support to find the optimum solution to make easy decision**
  - SinaSave directly compares your existing motors with SIMOTICS motors of various energy efficiency classes, for new systems and retrofits.
- **Ease of use and self-explanatory user guidance to calculate savings potential on overall system level**
  - SinaSave compares different drive system configurations for pump or fan applications. Regardless of greenfield or brown-field projects, SinaSave offers the flexibility to choose from different motor types and control modes, including variable speed drives and softstarters.
- **Well-structured SinaSave projects give you transparency of the savings potential of your entire facility**
  - SinaSave lets you combine several items in a single project. That means it's possible to reflect entire facilities and identify the savings potential they offer.

#### Function

- Determine savings potential for energy, power costs, and CO<sub>2</sub>
- Estimate expected amortization and Total Costs of Ownership (TCO)
- Output of system power losses for motor inverter systems as per IEC 61800-9-2
- Calculate possible financing, such as energy performance contracting (EnPC)
- Take government subsidies into account
- Simple design with intuitive usability
- Results presented in graphic form
- Save and load, share a handout e.g with your customer or decision-maker
- Eight languages, 14 currencies, IEC and NEMA standards
- Direct transfer to next processes, e.g. product configuration

#### More information

Further information about the amortization calculator for energy-efficient drive systems is available on the internet at:

[www.siemens.com/tools-sinasave](http://www.siemens.com/tools-sinasave)

Further information about services for energy saving is available on the internet at:

[www.siemens.com/energy-saving](http://www.siemens.com/energy-saving)

[www.siemens.com/energy-efficiency](http://www.siemens.com/energy-efficiency)



## SIZER for Siemens Drives engineering tool (integrated in the TIA Selection Tool)

## Overview

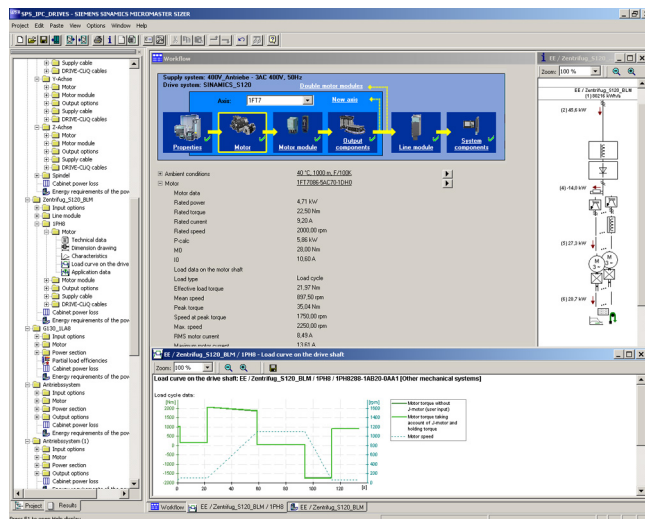

The following drives and controls can be engineered in a user-friendly way using the SIZER for Siemens Drives engineering tool:

- SIMOTICS low-voltage motors, including servo geared motors
- SIMOGEAR geared motors
- SINAMICS low-voltage drive systems
- Motor starters
- SINUMERIK CNC
- SIMOTION Motion Control controller
- SIMATIC controller

It provides support when selecting the technologies involved in the hardware and firmware components required for a drive task. SIZER for Siemens Drives covers the full range of operations required to configure a complete drive system, from basic single drives to demanding multi-axis applications.

SIZER for Siemens Drives supports all of the engineering steps in one workflow:

- Configuring the power supply
- Designing the motor and gearbox, including calculation of mechanical transmission elements
- Configuring the drive components
- Compiling the required accessories
- Selecting the line-side and motor-side power options, e.g. cables, filters, and reactors

When SIZER for Siemens Drives was being designed, particular importance was placed on a high degree of usability and a universal, function-based approach to the drive application. The extensive user guidance makes it easy to use the tool. Status information keeps you continually informed about the progress of the configuration process.

The drive configuration is saved in a project. In the project, the components and functions used are displayed in a hierarchical tree structure.

The project view permits the configuration of drive systems and the copying/inserting/modifying of drives already configured.

The configuration process produces the following results:

- A parts list of the required components (export to Excel, use of the Excel data sheet for import to SAP)
- Technical specifications of the system
- Characteristic curves
- Comments on line harmonic distortions
- Mounting arrangement of drive and control components and dimensional drawings of motors
- Energy requirements of the configured application

These results are displayed in a results tree and can be reused for documentation purposes.

Support is provided by the technological online help menu:

- Detailed technical specifications
- Information about the drive systems and their components
  - Decision-making criteria for the selection of components
- Online help in English, French, German, Italian, Chinese and Japanese

**System requirements**

- PG or PC, with Pentium III min. 800 MHz (recommended > 1 GHz)
- 512 MB RAM (1 GB RAM recommended)
- At least 2 GB of free hard disk space
- An additional 100 MB of free hard disk space on Microsoft Windows system drive
- Screen resolution 1024 × 768 pixels
- Operating system:
  - Microsoft Windows 7 (32/64-bit) Professional, Enterprise, Ultimate, Home
  - Microsoft Windows 8.1 (32/64-bit) Professional, Enterprise, Ultimate, Home
  - Microsoft Windows 365
  - Microsoft Windows 10 (64-bit) Professional, Enterprise
- Microsoft Office 2003/2007/2010/2013/2016/365
- Microsoft Internet Explorer V8.0
- Microsoft .NET Framework 2.0
- OpenGL 2.1

**More information**Drive dimensioning in the TIA Selection Tool

Application-specific requirements can be determined using drive technology dimensioning in the TIA Selection Tool. This can include motors, gearboxes and converters. The tool supports the configuration and dimensioning of control functions with an open and closed control loop. The technical documentation with features of the technical drive system, as well as a product list for ordering via the Industry Mall can also be compiled.

You can find more information on the SIZER for Siemens Drives engineering tool at

<https://support.industry.siemens.com/cs/ww/en/ps/13434/dl>

You can find more information about the TIA Selection Tool at: [www.siemens.com/tia-selection-tool](http://www.siemens.com/tia-selection-tool)

# Engineering tools

## STARTER commissioning tool

### Overview

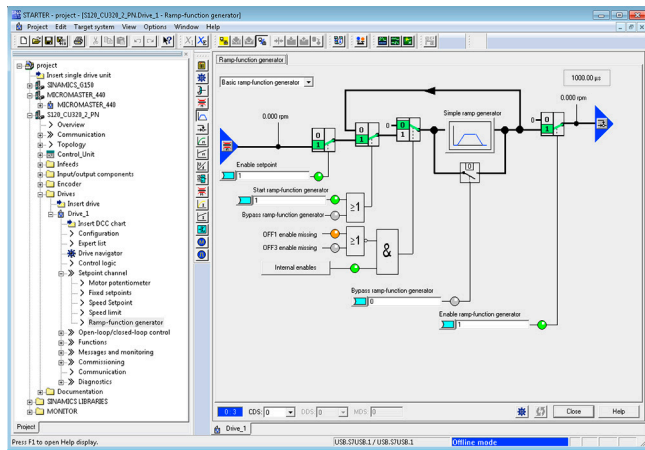

The user-friendly STARTER commissioning tool can be used for:

- Commissioning
- Optimization
- Diagnostics

This software can be operated as a standalone PC application, or integrated as a TIA-compatible program in SIMATIC STEP 7, or highly integrated into the SCOUT Engineering System (for SIMOTION). The basic functions and handling are the same in both cases.

In addition to the SINAMICS drives, STARTER also supports MICROMASTER 4 devices.

The project wizards can be used to create the drives within the structure of the project tree.

Beginners are supported by solution-based dialog guidance, whereby a standard graphics-based display maximizes clarity when setting the drive parameters.

First commissioning is guided by a wizard which makes all the basic settings in the drive. Therefore, getting a motor up and running is merely a question of setting a few of the drive parameters as part of the drive configuration process.

The individual settings required are made using graphics-based parameterization screens, which also precisely visualize the principle of operation of the drive.

Examples of individual settings that can be made include:

- Use of terminals
- Bus interface
- Setpoint channel (e.g. fixed setpoints)
- Closed-loop speed control (e.g. ramp-function generator, limits)
- BICO interconnections
- Diagnostics

For experts, the expert list can be used to specifically and quickly access individual parameters at any time. An individual compilation of frequently used parameters can be saved in dedicated user lists and watch tables.

In addition, the following functions are available for optimization purposes:

- Self-optimization of the controller settings (depending on drive unit)
- Setup and evaluation of trace recordings<sup>1)</sup>
  - Tool function for recording 2 × 8 signals with
  - Measuring cursor function
  - Extensive trigger functions
  - Several Y scales
  - Sampling times in the current controller cycle clock

Diagnostics functions provide information about:

- Control/status words
- Parameter status
- Operating conditions
- Communication states

### Performance features

- User-friendly: Only a small number of settings need to be made for successful first commissioning: The motor starts to rotate
- Solution-oriented dialog-based user guidance simplifies commissioning
- Self-optimization functions reduce manual effort for optimization.

### System requirements

The following minimum requirements must be complied with:

- Hardware
  - PG or PC with Pentium III min. 1 GHz (recommended >1 GHz)
  - Work memory 2 GB (4 GB recommended)
  - Screen resolution 1024 × 768 pixels, 16-bit color depth
  - Free hard disk memory: min. 5 GB
- Software
  - Microsoft Internet Explorer V6.0 or higher
  - 64-bit operating systems:
    - Microsoft Windows Server 2019
    - Microsoft Windows Server 2022
    - Microsoft Windows 10 Pro
    - Microsoft Windows 10 Enterprise
    - Microsoft Windows 11 Pro
    - Microsoft Windows 11 Enterprise

### Supported virtualization platforms

STARTER (V5.1 SP1 and higher) can be installed on a virtual machine. For this purpose, one of the following virtualization platforms in the specified version or a newer version can be used:

- VMware vSphere Hypervisor (ESXi) 6.7 Update 2
- VMware Workstation pro V16.2.4
- VMware Player V16.2.4
- Microsoft Windows Server 2019 Hyper-V

You can use the following guest operating systems to install STARTER within the selected virtualization platform:

- Microsoft Windows 10 Professional/Enterprise (64-bit)
- Microsoft Windows 11 Professional/Enterprise (64 bit)

<sup>1)</sup> Depending on drive unit.  
Not supported for MICROMASTER 4, SINAMICS G110, SINAMICS G120 <firmware V4.4, SINAMICS G110D and SINAMICS G120D <firmware V4.5.

## STARTER commissioning tool

## Integration

Data can be exchanged (depending on the version) via PROFIBUS or PROFINET/Ethernet or via a serial interface.

For commissioning and service, a PG/PC can be connected to the CU320-2 Control Unit via PROFIBUS. A PROFIBUS connection must be available with a connecting cable at the PG/PC.

Further, communication between a CU320-2 Control Unit and PG/PC can also be established via Ethernet, either via an (optional) CBE20 Communication Board or the Ethernet interface -X127 on the CU320-2 Control Unit.

Note:

The terminal strip -X127 is suitable as a communication link to the PG/PC only for the purposes of servicing and commissioning.

## Selection and ordering data

Description	Article No.
<b>STARTER commissioning tool</b> Single license and certificate of license German, English, French, Italian, Spanish	
• On DVD-ROM	<b>6SL3072-0AA00-0AG0</b>
• Software download (email address required for delivery)	<b>6SL3072-0AA00-0AK0</b>

**Accessories**

Depending on the version of the Control Unit (CU), the Control Unit of the drive unit can communicate with the programming device (PG) or PC via PROFIBUS or PROFINET/Ethernet or via a serial interface. The following accessories are available for the particular drive system as listed in the following table.

Description	Recommended accessories
	For communication between the drive unit and the programming device or PC
	Article No.
<b>SINAMICS G120C</b>	
• USB	<b>PC converter connection kit 2</b> Mini USB interface cable for communication with a PC, 3 m (9.84 ft)
	<b>6SL3255-0AA00-2CA0</b>
<b>SINAMICS G120</b>	
• USB	<b>PC converter connection kit 2</b> Mini USB interface cable for communication with a PC, 3 m (9.84 ft)
	<b>6SL3255-0AA00-2CA0</b>
• PROFIBUS	<b>SIMATIC DP plug-in cable</b> 12 MBaud, for PG connection, pre-assembled with 2 × 9-pin SUB D connector, 3 m (9.84 ft)
	<b>6ES7901-4BD00-0XA0</b>
• PROFINET/ Ethernet	Standard CAT5 Ethernet cable or PROFINET cable
	–
<b>SINAMICS S110</b>	
• RS232	<b>Standard null modem cable</b>
	–
• PROFIBUS	<b>CP 5711 communication module</b> USB adapter for connecting a PG or notebook to PROFIBUS or MPI USB cable (2 m (6.56 ft)) included in scope of supply
	<b>6GK1571-1AA00</b>
	<b>SIMATIC DP plug-in cable</b> 12 MBaud, for PG connection, pre-assembled with 2 × 9-pin SUB D connector, 3 m (9.84 ft)
	<b>6ES7901-4BD00-0XA0</b>
• PROFINET/ Ethernet	Standard CAT5 Ethernet cable or PROFINET cable
	–

**More information**

The STARTER commissioning tool is also available on the internet under [www.siemens.com/starter](http://www.siemens.com/starter)

## Tools and engineering

### Engineering Tools

#### SINAMICS Startdrive commissioning tool

##### Overview

SINAMICS Startdrive is integrated in the TIA Portal and is a tool for the configuration, commissioning and diagnostics of the SINAMICS family of converters.

The SINAMICS Startdrive commissioning tool has been optimized with regard to user friendliness and consistent use of the TIA Portal benefits of a common working environment for PLC, HMI and drives. Time-saving and guided step-by-step commissioning with maximum flexibility is complemented by user-friendly graphic function views for all drive functions, including functional safety (Safety Integrated) and drive-based technology functions (e.g. EPos). The automatic message display, the powerful real-time trace and the context-sensitive online help make converter diagnostics very easy.

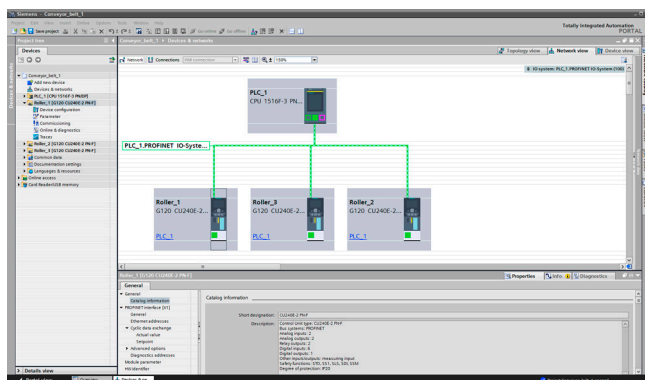

The software packages based on the TIA Portal are harmonized with each other and offer important benefits, the main advantage being a shared project storage. The TIA Portal enables simple integration of SINAMICS converters in your automation solution. Thanks to the standardization of operator actions and the integration in general TIA Portal operating concepts (e.g. UMAC, Openness) as well as standard TIA Portal functions (e.g. Undo/Redo), familiarization is easy both for drive experts as well as SIMATIC users. Special focus is placed on the interaction between SIMATIC and SINAMICS, especially when connecting the SINAMICS drives to SIMATIC technology objects.

##### Integration

###### Supported frequency converters

SINAMICS Startdrive Basic enables complete commissioning, diagnostics, parameterization, optimization and connection to the PLC for the following SINAMICS converters integrated in SINAMICS Startdrive:

- SINAMICS G120, G120C, G120D, G120P
- SINAMICS G115D
- SINAMICS G130, G150
- SINAMICS S120 <sup>1)</sup>, S150
- SINAMICS S210 and SINAMICS S210 (New) (as of V18 SP1)
- SINAMICS MV

##### SINAMICS Startdrive Advanced

With SINAMICS Startdrive Advanced (available as of V15) you benefit from powerful engineering functions that save you considerable time and ultimately costs.

- Advanced functions for SINAMICS Startdrive: Safety acceptance test (available for SINAMICS G120, G120C, G115D, G120D, G120P, G130, G150, S120, S150 and S210)
  - Guided acceptance test wizard for all drive-based Safety Integrated functions (Basic, Extended and Advanced Safety)
  - Automatic and safety function-specific generation of traces to analyze the machine behavior
  - Generation of an acceptance report as Excel file (xlsx format, can also be used with OpenOffice)
  - Safety Activation Test
- Improved optimization options in the drive for CU320-2 PN/DP and CU310-2 PN-based drive units: Extended measuring functions (available as of V5.2 SP3), Trace without trigger condition (ring buffer)
- Also contains all Startdrive Basic functions
- Only license key required, no additional installation

##### New in V18

###### Startdrive Basic V18

- Extension for UMAC: Additional function rights for changes to Safety parameters and for the control panel
- Support for station upload for F-PLCs and drives connected via PROFIsafe
- Extension of the SINAMICS MV family: Support for SINAMICS firmware V5.2 SP7
- Extensions for CU320-2 PN/DP and CU310-2 PN-based drive units:
  - Support for linear motors (1FN1, 1FN3 and third-party motors)
  - FFT (Fast Fourier Transformation) analysis of recorded trace signals
- SLS (Safely-Limited Speed) function for SINAMICS G115D (new from V18 SP1)

###### Startdrive Advanced V18

- Safety Activation Test extension: Recording of selectable signals and states during the test, with transfer to log feature
- Expansion for CU320-2 PN/DP and CU310-2 PN-based drive units: Trace without trigger condition (ring buffer for continuous monitoring of signals)

<sup>1)</sup> Includes SINAMICS S220 Smart Line Modules booksize format as of SINAMICS Startdrive V17 Update 1.

**Integration****Installation versions**

SINAMICS Startdrive can be installed as an optional package to SIMATIC STEP 7 or as a stand-alone application (without SIMATIC STEP 7).

**System requirements**

The following table shows the recommended hardware and system equipment for the operation of SINAMICS Startdrive.

Hardware	Recommendation
<b>Computer</b>	As of SIMATIC FIELD PG M6 Comfort (or comparable PC)
<b>Processor</b>	Intel Core i5-8400H (2.5 ... 4.2 GHz; 4 cores + hyper-threading; 8 MB Smart Cache)
<b>RAM</b>	16 GB or more (32 GB for large projects)
<b>Hard disk</b>	SSD with at least 50 GB available memory
<b>Screen resolution</b>	15.6" Full HD display (1920 × 1080 or larger)
<b>Operating systems</b>	<ul style="list-style-type: none"> <li>• <b>Microsoft Windows 10 (64 bit)</b> <ul style="list-style-type: none"> <li>- Windows 10 Professional Version 21H1, 21H2</li> <li>- Windows 10 Enterprise 2009/20H2, 21H1, 21H2</li> <li>- Windows 10 IoT Enterprise 2016 LTSC</li> <li>- Windows 10 IoT Enterprise 2019 LTSC</li> <li>- Windows 10 IoT Enterprise 2021 LTSC</li> </ul> </li> <li>• <b>Microsoft Windows 11 (64 bit)</b> <ul style="list-style-type: none"> <li>- Windows 11 Home Version 21H2</li> <li>- Windows 11 Professional Version 21H2</li> <li>- Windows 11 Enterprise 21H2</li> </ul> </li> <li>• <b>Microsoft Windows Server (64 bit)</b> <ul style="list-style-type: none"> <li>- Windows Server 2016 Standard (full installation)</li> <li>- Windows Server 2019 Standard (full installation)</li> <li>- Windows Server 2022 Standard (full installation)</li> </ul> </li> </ul>

**Compatibility with other products**

- SINAMICS Startdrive V18 SP1 operates with STEP 7, WinCC and Scout TIA V18 in one framework
- SINAMICS Startdrive V18 SP1 can be installed on the same computer in parallel with other versions of SINAMICS Startdrive V12 to V17
- SINAMICS Startdrive can be installed on the same computer as SINAMICS MICROMASTER STARTER

**Supported virtualization platforms**

SINAMICS Startdrive can be installed in a virtual machine. For this purpose, one of the following virtualization platforms in the specified version or a newer version can be used:

- Microsoft Windows 10 Professional Version 1909, 2004, 2009/20H2, 21H1, 21H2
- Microsoft Windows 10 Enterprise 1909, 2004, 2009/20H2, 21H1, 21H2
- Microsoft Windows 10 Enterprise 2016 LTSC
- Microsoft Windows 10 Enterprise 2019 LTSC
- Microsoft Windows 10 Enterprise 2021 LTSC

**Supported safety programs**

The following safety programs have been tested with SINAMICS Startdrive V18:

- Virus scanners:
  - Symantec Endpoint Protection 14.6
  - Trend Micro OfficeScan 14.0
  - McAfee Endpoint Security (ENS) 10.6 and 10.7
  - Microsoft Defender
  - Qihoo 360 "Safe Guard 12.1" + "Virus Scanner"
- Encryption software:
  - Microsoft Bitlocker
- Host-based Intrusion Detection System
  - McAfee Application Control 8.3.3

**Selection and ordering data**

Description	Article No.
<b>SINAMICS Startdrive Basic V18 SP1 commissioning tool</b> Single license and certificate of license English, French, German, Italian, Spanish, Chinese Simplified • On DVD-ROM • Software download (email address required for delivery)	<b>6SL3072-4JA02-0XA0</b> <b>6SL3072-4JA02-0XG0</b>
<b>SINAMICS Startdrive Advanced V18 SP1 commissioning tool</b> License key (floating license) English, French, German, Italian, Spanish, Chinese Simplified • On DVD-ROM with license key on USB flash drive • Software download incl. license key (email address required for delivery)	<b>6SL3072-4JA02-0XA5</b> <b>6SL3072-4JA02-0XG5</b>
<b>Upgrade SINAMICS Startdrive Advanced V15 ... V17 to V18</b> • On DVD-ROM with license key on USB flash drive • Software download incl. license key (email address required for delivery)	<b>6SL3072-4JA02-0XE5</b> <b>6SL3072-4JA02-0XK5</b>
<b>Software Update Service with SINAMICS Startdrive Advanced in the TIA Portal</b> Delivery is performed according to the number of ordered SUS products (e.g. 10 upgrade license keys (floating license) with 10 DVD-ROMs, 10 USB flash drives, etc.) • On DVD-ROM with upgrade license key on USB flash drive • Software download incl. license key (email address required for delivery)	<b>6SL3072-4AA02-0XL8</b> <b>6SL3072-4AA02-0XY8</b>

**Accessories**

Depending on the version of the Control Unit (CU), the Control Unit of the drive unit can communicate with the programming device (PG) or PC via PROFIBUS or PROFINET/Ethernet or via a serial interface. The following accessories are available for the particular drive system as listed in the following table.

## Tools and engineering

### Engineering Tools

#### SINAMICS Startdrive commissioning tool

##### Selection and ordering data

Description	Recommended accessories
	For communication between the drive unit and the programming device or PC Article No.
<b>SINAMICS G120C</b>	
• USB	<b>PC converter connection kit 2</b> Mini USB interface cable for communication with a PC, 3 m (9.84 ft) <b>6SL3255-0AA00-2CA0</b>
<b>SINAMICS G120</b>	
• USB	<b>PC converter connection kit 2</b> Mini USB interface cable for communication with a PC, 3 m (9.84 ft) <b>6SL3255-0AA00-2CA0</b>
• PROFIBUS	<b>SIMATIC DP plug-in cable</b> 12 MBaud, for PG connection, pre-assembled with 2 × 9-pin SUB D connector, 3 m (9.84 ft) <b>6ES7901-4BD00-0XA0</b>
• PROFINET/ Ethernet	Standard CAT5 Ethernet cable or PROFINET cable –

##### More information

The SINAMICS Startdrive Basic commissioning tool is available free on the internet at [www.siemens.com/startdrive](http://www.siemens.com/startdrive)

## Overview

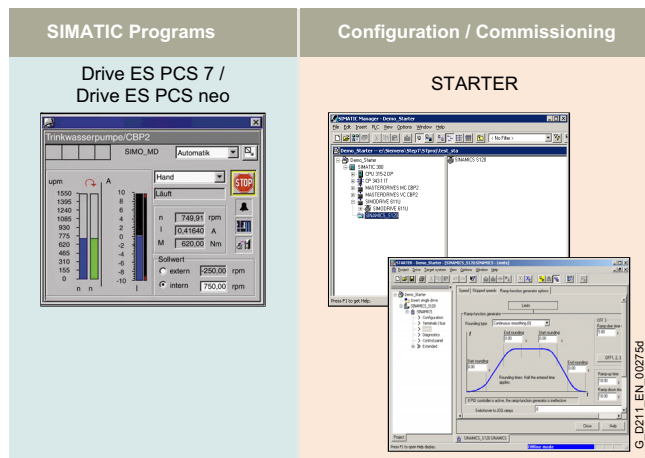

Drive ES/STARTER is the engineering system used to integrate the communication, configuration and data management functions of Siemens drive technology into the SIMATIC automation world easily, efficiently and cost-effectively.

The following software packages are available for selection:

- STARTER
- Drive ES PCS 7 / Drive ES PCS neo

The Drive ES (**Drive Engineering Software**) fully integrates drives from Siemens into the world of Totally Integrated Automation (STEP 7 V5.x).

## Design

The following software packages are available for selection:

- **STARTER**
- **Drive ES PCS 7** (APL Style or Classic Style) / **Drive ES PCS neo**

### STARTER

The STARTER commissioning tool is for first-time users of the world of Totally Integrated Automation and the basic software for setting the parameters of the SINAMICS and MICROMASTER 4 drives online and offline in this environment. The STARTER integration enables both the automation system and the drives to be handled using the SIMATIC Manager software. STARTER is the starting point for common data archiving in complete projects and for extending the use of the routing and the SIMATIC tele-service to drives. STARTER provides the configuration tools for the Motion Control functions – device-to-device communication, equidistance and isochronous operation with PROFIBUS DP and ensures that drives with PROFINET IO are simply integrated into the SIMATIC environment.

### Drive ES PCS 7 (APL Style or Classic Style)

Drive ES PCS 7 links the drives with a PROFIBUS DP interface into the SIMATIC PCS 7 process control system, and it requires that SIMATIC PCS 7, V6.1 and higher has first been installed. Drive ES PCS 7 provides a block library with blocks for the drives and the corresponding faceplates for the operator station, which enables the drives to be operated from the PCS 7 process control system. From V6.1 and higher, drives will also be able to be represented in the PCS 7 Maintenance Station.

From Drive ES PCS 7 V8.0 and higher, two versions of the library are available: The APL (Advanced Process Library) variant and the previous version in the so-called Classic Style.

### Detailed contents of the Drive ES PCS 7 (APL Style or Classic Style)

- **Block library for SIMATIC PCS 7** Faceplates and control blocks for SIMOVERT MASTERDRIVES VC and MC, as well as MICROMASTER/MIDIMASTER of the third and fourth generation and SIMOREG DC MASTER and SINAMICS
- **STEP 7 V5.x slave object manager** for user-friendly configuration of drives and non-cyclic PROFIBUS DP communication with the drives
- **STEP 7 V5.x device object manager** for easy configuration of drives with PROFINET-IO interfaces (V8.0 SP1 and higher)
- **SETUP program** for installing the software in the SIMATIC PCS 7 environment

### Drive ES PCS neo

Siemens SINAMICS drives can be controlled via SIMATIC PCS neo and operated and monitored on the OCM client with the SINAMICS library Drive ES PCS neo. The drive ES PCS neo faceplates make the data relevant for system operation available on the OCM client. The STARTER commissioning tool on the engineering server can also be used for parameter assignment, commissioning and detailed diagnostics of the SINAMICS drives.





## Drive applications

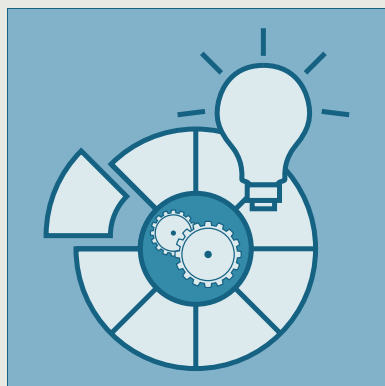

13/2

Drive applications

You can find additional information on the internet at  
[www.siemens.com/sinamics-applications](http://www.siemens.com/sinamics-applications)  
<https://support.industry.siemens.com>

# Drive applications

## Drive applications

### Overview

#### Standard applications: Understanding and profiting from know-how

The development of standard applications is a major area of activity within the Siemens automation and drive environment. The scope of these standard applications ranges from clearly organized documentation that focuses on one or several technologies (e.g. Safety Integrated) to complete, comprehensive, standardized solutions for complex tasks (e.g. cross cutters).

#### Standard application requirements

One feature that all application examples have in common is that they are designed to help users help themselves. They have been created by developers with extensive tool, commissioning and application know-how to make them as user-friendly as possible. Standard applications generally provide the user with reusable components.

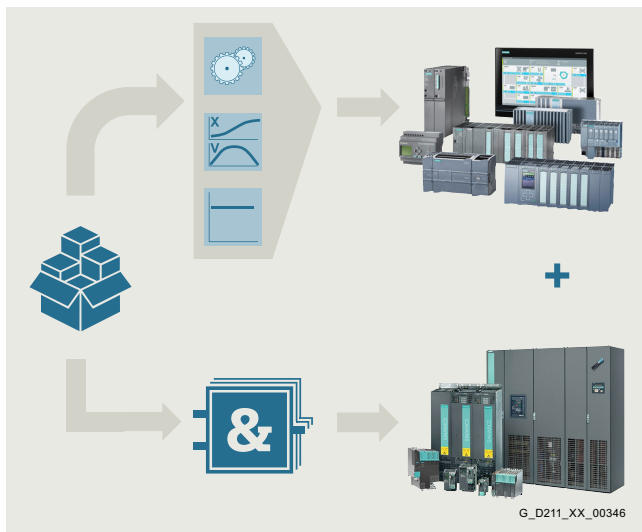

Technology functions in the higher-level control system

- Tested SIMATIC PLC blocks
- Reusable HMIs and faceplates

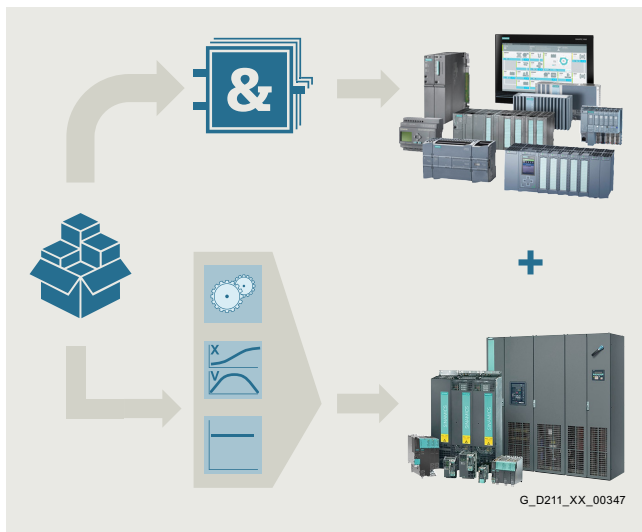

Technology functions in the drive

- Tested SIMATIC PLC blocks
- Reusable HMIs and faceplates
- Application-specific Drive Control Charts (DCC)

### Expandable drive technologies

<p><b>BICO</b></p>	<p><b>B</b>inector &amp; <b>C</b>onconnector Technology</p> <p>Linkability of binary and analog signals directly in the drive (cf. with a soldering iron)</p>
<p><b>FFB</b></p>	<p><b>F</b>ree <b>F</b>unction <b>B</b>locks</p> <p>Fixed predefined blocks in limited number</p>
<p><b>EPos</b></p>	<p><b>E</b>asy <b>B</b>asic <b>P</b>ositioner</p> <p>Completely autonomous positioning function in the drive (referencing, traversing tables, MDI, etc.)</p>
<p><b>PID</b></p>	<p><b>T</b>echnology <b>C</b>ontroller</p> <p>Additional <b>PID</b> controllers for applicative process control loops</p>

G\_D011\_EN\_00419

Standard technology functions

<p><b>TEC</b></p>	<p><b>SINAMICS</b></p> <p><b>T</b>echnology <b>E</b>xtensions</p> <p>Configurable functions-/technology modules for application-specific tasks to additional extension of firmware functions</p>
<p><b>DCC</b></p>	<p><b>SINAMICS</b></p> <p><b>D</b>rive <b>C</b>ontrol <b>C</b>hart</p> <p>Creating own and complex technology functions based on graphic signal processing diagrams with standard and extension libraries</p>

G\_D011\_EN\_00494a

Advanced technology functions

The development of standard technological applications is a dedicated area of activity within the Siemens automation and drive environment. Owing to the generally large size of the applications, they are supplied with detailed documentation and example codes.

These applications focus on the use of product features such as SINAMICS Drive Control Chart (DCC) with its Drive Control Block (DCB) libraries of DCB Standard and DCB Extension, SINAMICS Technology Extensions (TEC) and Free Function Blocks (FFB).

This enables extensive, complete and standardized solutions to be developed for complex drive tasks.

These solutions can be flexibly adapted while at the same time allowing the user to expand them with additional elements or special functions as required.

## Overview

### **Application examples**

Freely available application examples offer:

- Explanation of the necessary configuring steps with Siemens engineering tools
- Reusable standardized blocks for SIMATIC PLC
- Functionally coordinated programs and blocks
- Significantly shorter commissioning times

Various application examples also explain how to use Free Function Blocks (FFB), logic processing integrated in the drive with Drive Control Chart (DCC) and Safety Integrated.

The following application examples are just a selection of some of the many applications that are available on the internet at:

- SINAMICS G: Controlling a speed axis with the "SINA\_SPEED" block  
<https://support.industry.siemens.com/cs/document/109485727>
- SIMATIC S7-1200 / S7-1500: Encoderless Positioning with SINAMICS G  
<https://support.industry.siemens.com/cs/document/109767951>
- Configuring Technology Objects with SIMATIC S7-1500 and SINAMICS S210 in TIA Portal  
<https://support.industry.siemens.com/cs/document/109749795>
- SINAMICS S: SINAMICS S120 web server – user-defined sample pages  
<https://support.industry.siemens.com/cs/document/78388880>
- SIMATIC – Fail-safe LDrvSafe library for controlling Safety Integrated Functions for the SINAMICS converter family  
<https://support.industry.siemens.com/cs/document/109485794>

You can find additional information on the internet at:

[www.siemens.com/sinamics-applications](http://www.siemens.com/sinamics-applications)

<https://support.industry.siemens.com>

# Drive applications

## Drive applications

### Integration

#### Overview of drive applications for SINAMICS drives, including SIMATIC ET 200pro FC-2 frequency converters

Drive applications	Low voltage									
	Standard Performance frequency converters						Distributed frequency converters			SIMATIC ET 200pro FC-2 <sup>1)</sup>
	SINAMICS V20		G120C	G120		G130 G150	SINAMICS G115D		G120D	
			CU230P-2	CU240E-2	CU250S-2	CU320-2		CU240D-2	CU250D-2	
<b>Standard technology functions</b>										
BICO technology	✓	✓	✓	✓	✓	✓	✓	✓	✓	✓
Free Function Blocks (FFB)	✓	✓	✓	✓	✓	✓	✓	✓	✓	–
Basic positioner (EPos)	–	–	–	–	✓	–	–	–	✓	–
Technology controller (PID)	✓	✓	✓	✓	✓	✓	✓	✓	✓	–
<b>Advanced technology functions</b>										
SINAMICS Drive Control Chart (DCC)	–	–	–	–	–	✓	–	–	–	–
SINAMICS Technology Extension (TEC)	–	–	–	–	–	✓	–	–	–	–
<b>Applications &amp; Branch know-how</b>										

Siemens has applied these technology functions (standard and/or advanced) to generate numerous application solutions. These applications can be downloaded from the Siemens application support website at: [www.siemens.com/sinamics-applications](http://www.siemens.com/sinamics-applications)

Drive applications	Low voltage									
	Industry-specific frequency converters			Servo converters			High performance frequency converters			
	SINAMICS G120P		G120X	G180 <sup>2)</sup>	V90	S110	S210	S120 S120M		S150
	CU230P-2		CB08		CU305		CU310-2	CU320-2	CU320-2	
<b>Standard technology functions</b>										
BICO technology	✓	✓	✓	–	✓	–	✓	✓	–	–
Free Function Blocks (FFB)	✓	✓	–	–	✓	–	✓	✓	–	–
Basic positioner (EPos)	–	–	–	✓	✓	–	✓	✓	–	–
Technology controller (PID)	✓	✓	✓	–	✓	–	✓	✓	–	–
<b>Advanced technology functions</b>										
SINAMICS Drive Control Chart (DCC)	–	–	–	–	–	–	✓	✓	–	–
SINAMICS Technology Extension (TEC)	–	–	–	–	–	–	✓	✓	–	–
<b>Applications &amp; Branch know-how</b>										

Siemens has applied these technology functions (standard and/or advanced) to generate numerous application solutions. These applications can be downloaded from the Siemens application support website at: [www.siemens.com/sinamics-applications](http://www.siemens.com/sinamics-applications)

<sup>1)</sup> Information on the SIMATIC ET 200pro FC-2 frequency converter with PROFINET, PROFIBUS DP or EtherNet/IP – depending on the SIMATIC ET 200pro station – is available at: [www.siemens.com/et200pro-fc](http://www.siemens.com/et200pro-fc)

<sup>2)</sup> SINAMICS G180 has its own Control Unit with its own firmware. Compared to the SINAMICS firmware, some functionalities are not available or implemented differently.

## Services and documentation

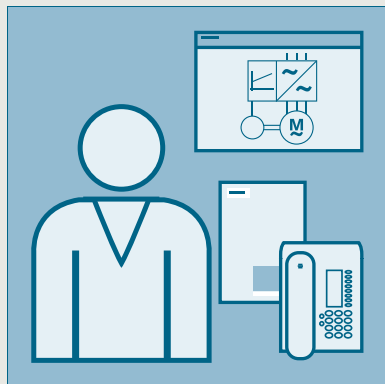

<b>14/2</b>	<b>Partner</b>
<b>14/3</b>	<b>Industry Services</b>
14/4	Industry Services – Portfolio overview
14/5	Online Support
<b>14/6</b>	<b>Training</b>
14/6	SITRAIN – Digital Industry Academy
14/8	Training courses for SINAMICS low-voltage converters
14/9	SINAMICS V20 training case
14/9	SINAMICS G120C training case
14/10	SINAMICS G120 training case single-axis drive
<b>14/12</b>	<b>Control cabinets</b>
<b>14/14</b>	<b>Applications</b>
<b>14/15</b>	<b>Field and maintenance services</b>
14/15	General overhaul
14/15	Function check
<b>14/16</b>	<b>Spare parts services</b>
14/16	Delivery of spare parts
14/17	Delivery as exchange product
14/17	Product upgrade service
14/18	Return of diagnostic parts
14/18	Stock reduction in spare parts store
14/18	Extended spare part availability
<b>14/19</b>	<b>Repair services</b>
<b>14/20</b>	<b>Spares on Web</b>
<b>14/21</b>	<b>Drives Options Partner</b>
<b>14/22</b>	<b>mySupport documentation</b>
<b>14/23</b>	<b>Documentation</b>
14/23	General documentation

# Services and documentation

## Partner

### Overview

#### Partners at Siemens

The screenshot shows the Siemens website interface for finding partners. At the top, there are navigation tabs for 'Competence' (Spare parts / Repairs / Call...), 'Products' (All Products and Branches), and 'Region' (All Regions). Below this is a search bar with a warning message: 'Please choose a city in the upper search field, if possible. Or select a city or a contact person on the map on the right. If you do not find your city in the selection, we recommend choosing the nearest city.' The main content area is divided into two columns. The left column shows details for two Siemens locations: Siemens NV/SA in Belgium and Siemens SPA in Algeria. Each entry includes the company name, address, communication data (phone numbers, email, website), and filter buttons for Competences, Products & Branches, and Region. The right column features a map of Europe with numerous location markers, indicating the global reach of Siemens services.

At your service locally, around the globe for consulting, sales, training, service, support, spare parts on the entire portfolio of Siemens.

Your partner can be found in our Personal Contacts Database at: [www.siemens.com/automation-contact](http://www.siemens.com/automation-contact)

You start by selecting

- the required competence,
- products and branches,
- a country and a city

or by a

- location search or free text search.

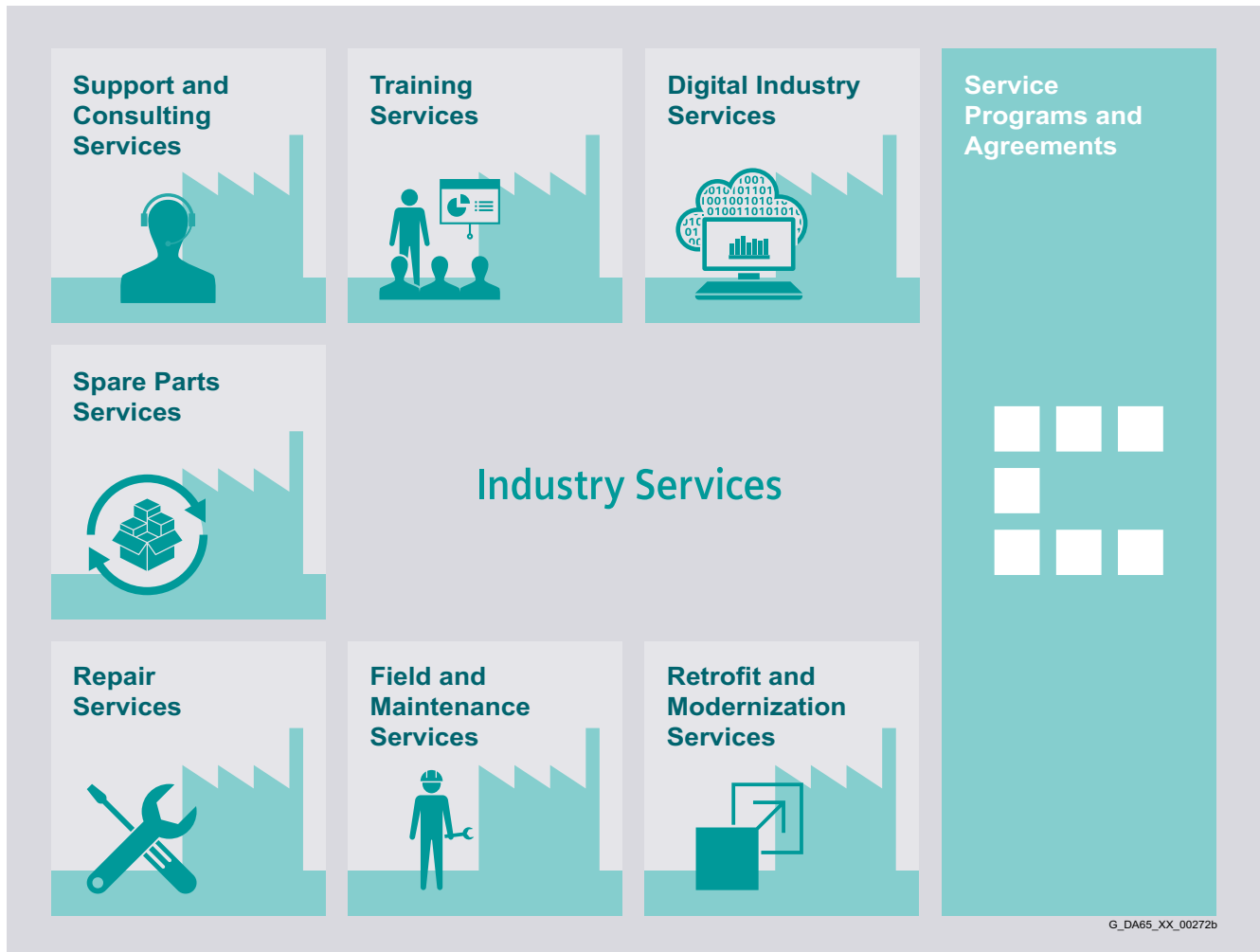
**Overview**

**Keep your business running and shaping your digital future – with Industry Services**

Optimizing the productivity of your equipment and operations can be a challenge, especially with constantly changing market conditions. Working with our service experts makes it easier.

We understand your industry's unique processes and provide the services needed so that you can better achieve your business goals.

You can count on us to maximize your uptime and minimize your downtime, increasing your operations' productivity and reliability. When your operations have to be changed quickly to meet a new demand or business opportunity, our services give you the flexibility to adapt. Of course, we take care that your production is protected against cyber threats. We assist in keeping your operations as energy and resource efficient as possible and reducing your total cost of ownership. As a trendsetter, we ensure that you can capitalize on the opportunities of digitalization and by applying data analytics to enhance decision making: You can be sure that your plant reaches its full potential and retains this over the longer lifespan.

You can rely on our highly dedicated team of engineers, technicians and specialists to deliver the services you need – safely, professionally and in compliance with all regulations. We are there for you, where you need us, when you need us.

[www.siemens.com/industryservices](http://www.siemens.com/industryservices)

## Services and documentation

### Industry Services

#### Industry Services – Portfolio overview

##### Overview



#### Digital Industry Services

Digital Industry Services make your industrial processes transparent to gain improvements in productivity, asset availability, and energy efficiency.

Production data is generated, filtered and translated with intelligent analytics to enhance decision-making.

This is done whilst taking data security into consideration and with continuous protection against cyber-attack threats.

[www.siemens.com/global/en/products/services/industry/digital-industry-services.html](https://www.siemens.com/global/en/products/services/industry/digital-industry-services.html)



#### Training Services

From the basics and advanced to specialist skills, SITRAIN courses provide expertise right from the manufacturer – and encompass the entire spectrum of Siemens products and systems for the industry.

Worldwide, SITRAIN courses are available wherever you need a training course in more than 170 locations in over 60 countries.

<https://support.industry.siemens.com/cs/ww/en/sc/2226>



#### Support and Consulting Services

**Industry Online Support** site for comprehensive information, application examples, FAQs and support requests.

**Technical and Engineering Support** for advice and answers for all inquiries about functionality, handling, and fault clearance. The Service Card as prepaid support for value added services such as Priority Call Back or Extended Support offers the clear advantage of quick and easy purchasing.

**Information & Consulting Services**, e.g. SIMATIC System Audit; clarity about the state and service capability of your automation system or Lifecycle Information Services; transparency on the lifecycle of the products in your plants.

<https://support.industry.siemens.com/cs/ww/en/sc/2235>



#### Spare Parts

Spare Parts Services are available worldwide for smooth and fast supply of spare parts – and thus optimal plant availability. Genuine spare parts are available for up to ten years. Logistic experts take care of procurement, transport, custom clearance, storage and order manage-

ment. Reliable logistics processes ensure that components reach their destination as needed.

Since not all spare parts can be kept in stock at all times, Siemens offers a preventive measure for spare parts provisioning on the customer's premises with optimized **Spare Parts Packages** for individual products, custom-assembled drive components and entire integrated drive trains – including risk consulting.

**Asset Optimization Services** help you design a strategy for parts supply where your investment and carrying costs are reduced and the risk of obsolescence is avoided.

<https://support.industry.siemens.com/cs/ww/en/sc/2110>



#### Repair Services

Repair Services are offered on-site and in regional repair centers for fast restoration of faulty devices' functionality.

Also available are extended repair services, which include additional diagnostic and repair measures, as well as emergency services.

<https://support.industry.siemens.com/cs/ww/en/sc/2154>



#### Field and Maintenance Services

Siemens specialists are available globally to provide expert field and maintenance services, including commissioning, functional testing, preventive maintenance and fault clearance.

All services can be included in customized service agreements with defined reaction times or fixed maintenance intervals.

<https://support.industry.siemens.com/cs/ww/en/sc/2265>



#### Retrofit and Modernization Services

Provide a cost-effective solution for the expansion of entire plants, optimization of systems or upgrading existing products to the latest technology and software, e.g. migration services for automation systems.

Service experts support projects from planning through commissioning and, if desired over the entire extended lifespan, e.g. Retrofit for Integrated Drive Systems for an extended lifetime of your machines and plants.

<https://support.industry.siemens.com/cs/ww/en/sc/2286>



#### Service Programs and Agreements

A technical Service Program or Agreement enables you to easily bundle a wide range of services into a single annual or multi-year agreement.

You pick the services you need to match your unique requirements or fill gaps in your organization's maintenance capabilities.

Programs and agreements can be customized as KPI-based and/or performance-based contracts.

<https://support.industry.siemens.com/cs/ww/en/sc/2275>



Overview

Online Support – fast, intuitive, whenever you want, wherever you need

**Web**  
www.siemens.com/online-support

**App**

GET IT ON Google Play | Learn on the App Store | Herunterladen von Microsoft

Scan the QR code for information on our Online Support app.

- FAQ / Application examples**  
Information about industrial products, programming and configuration as well as application examples
- Technical information**  
Videos, documentation, manuals, updates, product notes, compatibility tool, certificates, planning data such as dimensional drawings, product data, 3D models
- Forum**  
Exchange information and experience with other users and experts

## Online Support for Siemens Industry Products

Siemens Industry and Online Support with some 1.7 million visitors per month is one of the most popular web services provided by Siemens. It is the central access point for comprehensive technical know-how about products, systems and services for automation and drives applications as well as for process industries.

In connection with the challenges and opportunities related to digitalization you can look forward to continued support with innovative offerings.

## Services and documentation

### Training

#### SITRAIN – Digital Industry Academy

#### Introduction



SITRAIN – DIGITAL INDUSTRY ACADEMY  
**The Future of Learning starts now**

SITRAIN - Digital Industry Academy stands for a modern learning culture that focuses on the needs of learners and the demands of innovative companies.

SITRAIN offers a comprehensive range of knowledge on Siemens industrial products and, under the vision "Future of Learning", pursues a holistic approach that combines different forms and methods of learning. Different learning formats allow for more effective, flexible and continuous learning depending on the type of learning.

#### Education and training directly from the manufacturer



##### Industrial Automation Systems SIMATIC

Training available for: SIMATIC S7-1500, TIA Portal, SIMATIC S7-300/400, SIMATIC S7-1200



##### Drive Technology

Training available for: SINAMICS S120 and SINAMICS G120 low-voltage converters, SINAMICS G130 / G150 / G180 / S150



##### SINUMERIK CNC automation system

Training available for: SINUMERIK 840D, SINUMERIK 840D sl and SINUMERIK ONE



##### Process Control Systems

Training available for: SIMATIC PCS 7, SIMATIC PCS neo



##### Digital Enterprise

Training available for: Openness, SIMIT, OPC UA, Industrial Edge, Virtual commissioning



##### Industrial Communications

Training available for: PROFINET, SCALANCE, RUGGEDOM, Industrial Ethernet, Fieldbus communication, Industrial Security, Remote communication

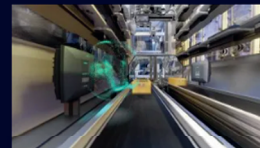

##### Identification and Locating

Training available for: RFID, RTLS-Systems



##### Operator Control and Monitoring Systems

Training available for: SIMATIC WinCC Unified in TIA Portal, SIMATIC WinCC in TIA Portal, SIMATIC WinCC V7x

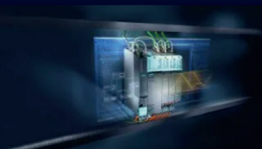

##### Motion Control System SIMOTION

Training available for: SIMOTION (Programming, Commissioning, Diagnostics, Service)



##### Smart Infrastructure

Training available for: SIRIUS, SENTRON, SIVACON, ALPHA, SIMOCODE, Circuit breakers



##### Process Analytics & Instrumentation

Training is available for process analytics and instrumentation, explosion protection, process gas chromatographs



##### Additional training offer

SIMOVE with Automated Guided Vehicles (AGV), SIPLUS CMS, Guidelines and standards for control cabinets

**Introduction**
**Different learning formats and methods for maximum learning success**

Face-to-face training in the training center or in the virtual classroom, with fixed dates and course times, learning in a group with a learning guide? Or digital training, on your own responsibility and location-independent, on demand, 24/7?

With the learning formats "Learning Journey", "Learning Membership" and "Learning Event", SITRAIN offers a wide range of different learning options in connection with didactically effective methods and modular possibilities.

**Learning Journey**

The combination for sustainable learning success

- The optimal mix of self-study units and guided live modules
- Includes a Learning Membership to work through the self-study modules and access on-demand content
- The SITRAIN learning consultant is available for questions and one-on-one consultations
- Ideal integration into the daily work routine and adaptation to one's own learning pace.

**Learning Membership**

Securing knowledge through continuous learning on your own responsibility

- With access to the comprehensive and constantly growing range of self-study units on SITRAIN access, the digital learning platform
- Search and find specific learning content or simply have a look around – anytime and anywhere
- A modern learning culture through continuous learning on your own responsibility and transparency about your learning success in the team or company.

**Learning Event**

Acquire theoretical and practical knowledge in a compact and guided format

- You achieve a defined learning goal in the shortest possible time
- The learning consultant guides you through the practical exercises and is also exclusively available to you during the theoretical sessions for the entire duration
- Focused learning, outside of the daily work routine, in a protected learning environment – virtually, in the training center, or at your company.

**Live**

Learn together with others, simultaneously and guided by a learning consultant. Online, in the SITRAIN training center or at your company.

**Self-reliant**

Expand your knowledge self-determined with industry learning and work on your learning units at your own pace and according to your own schedule.

**On demand**

Get the knowledge you need, exactly when you need it. Be it to answer a current question or to work on a special topic.

**Individuell**

Talk directly with the learning consultant, clarify detailed questions and get personal coaching for transferring the learned topics to your own application.

**Training cases catalog**

<https://www.siemens.com/sitRAIN-catalog-training-cases>

Find  
your local  
offer here

**SITRAIN – Digital Industry Academy worldwide**

You will find the regional knowledge offer in the country selection. One click will take you to the corresponding website.

## Services and documentation

### Training

#### Training courses for SINAMICS low-voltage converters

##### Overview

##### Training courses for SINAMICS drive system



This provides an overview of the training courses available for the SINAMICS drive system.

The courses are modular in design and are directed at a variety of target groups as well as individual customer requirements.

The system overview will acquaint decision-makers and sales personnel with the system very quickly.

The engineering course provides all the information you need to configure the drive system.

The courses dedicated to diagnostics and servicing, parameterization and commissioning, communication as well as extended functions such as Safety Integrated are sure to provide all the technical knowledge service engineers will need.

All courses contain as many practical exercises as possible to enable intensive and direct training on the drive system and with the tools in small groups.

Please also take note of the training options available for SIMOTICS motors. You will find more information about course contents and dates on the internet.

Title (all courses are available in English and German)	Target group			Duration	Order code
	Planners, decision-makers, sales personnel	Commissioning engineers, configuring engineers	Service personnel, maintenance technicians		
<b>Course Fundamentals and overview</b>					
SINAMICS and SIMOTICS - Basics of drive technology	✓	✓	✓	5 days	DR-GAT
<b>Courses SINAMICS S120</b>					
SINAMICS S120 Designing and Engineering	✓	–	–	5 days	DR-S12-PL
SINAMICS S120 Parameterizing and Commissioning with STARTER	–	✓	–	5 days	DR-S12-PM
SINAMICS S120 Parameterizing and Commissioning in the TIA Portal	–	✓	–	5 days	DR-S12-PMT
SINAMICS S120 Parameterizing Advanced	–	✓	–	5 days	DR-S12-PA
SINAMICS S120 Parameterizing Safety Integrated	–	✓	–	4 days	DR-S12-SAF
SINAMICS S120 Parameterizing and Optimization	–	✓	–	5 days	DR-S12-OPT
SINAMICS S120 Diagnostics and Service	–	–	✓	5 days	DR-S12-DG
SINAMICS S120 Diagnostics and Service in the TIA Portal	–	–	✓	5 days	DR-S12-DGT
SINAMICS S120 Diagnostics on Chassis and Cabinet Units	–	✓	✓	3 days	DR-S12-CHA
<b>Course SINAMICS G120 (including SINAMICS G120X, SINAMICS G120D and SINAMICS G115D)</b>					
Parameterizing and Commissioning	–	✓	–	2 days	DR-G12-PM
<b>Courses SINAMICS G130/G150/G180/S150</b>					
SINAMICS G150/G130/S150 - Diagnostics and Service	–	✓	✓	5 days	DR-G15-DG
SINAMICS G180 - Diagnostics and Service	–	–	✓	2.5 days	DR-G18-DG

## SINAMICS V20 training case

## Overview



SINAMICS V20 training case

The SINAMICS V20 training case is a convincing demonstration system thanks to its compact design. It is suitable for direct customer presentations as well as for tests in technical departments. It enables the functions of SINAMICS V20 to be demonstrated and tested quickly and easily.

It contains the following components:

- SINAMICS V20 converter, 0.12 kW (0.16 hp)
- SINAMICS V20 Smart Access
- SINAMICS V20 Parameter Loader
- SIMOTICS GP asynchronous (induction) motor

The SINAMICS V20 training case is supplied in the form of a stackable Tanos Systainer case of size 4.

## Technical specifications

	SINAMICS V20 training case
	6AG1067-2AA00-0AC6
<b>Supply voltage</b>	1 AC 230 V
<b>Dimensions</b>	
• Width	180 mm (7.09 in)
• Height	450 mm (17.72 in)
• Depth	400 mm (15.75 in)
<b>Weight, approx.</b>	9 kg (19.8 lb)

## Selection and ordering data

Description	Article-No.
<b>SINAMICS V20 training case</b>	<b>6AG1067-2AA00-0AC6</b>

## SINAMICS G120C training case

## Overview



SINAMICS G120C training case with IOP-2 Operator Panel

The SINAMICS G120C training case is a convincing demonstration system thanks to its compact design. It is suitable for direct customer presentations as well as for tests in technical departments. It enables the functions of SINAMICS G120C to be demonstrated and tested quickly and easily.

It contains the following components:

- SINAMICS G120C frequency converter, PROFINET / EtherNet/IP or PROFIBUS variants, 0.55 kW (0.75 hp)
- IOP-2 and BOP-2 operator panels and SINAMICS G120 Smart Access
- SIMOTICS GP asynchronous (induction) motor

The SINAMICS G120C training case is supplied in the form of a stackable Tanos Systainer case of size 4.

## Technical specifications

	SINAMICS G120C training case
	6AG1067-2AA00-0AA0 6AG1067-1AA25-0AA0
<b>Supply voltage</b>	1 AC 230 V
<b>Dimensions</b>	
• Width	315 mm (12.40 in)
• Height	400 mm (15.75 in)
• Depth	300 mm (11.81 in)
<b>Weight, approx.</b>	9 kg (19.8 lb)

## Selection and ordering data

Description	Article-No.
<b>SINAMICS G120C training case</b>	
• PROFINET / EtherNet/IP variant	<b>6AG1067-2AA00-0AA0</b>
• PROFIBUS variant	<b>6AG1067-1AA25-0AA0</b>

## Services and documentation

### Training

#### SINAMICS G120 training case single-axis drive

##### Overview



SINAMICS G120 training case single-axis drive

The basic version of the SINAMICS G120 training case single-axis drive contains the following components:

- SINAMICS PM240-2 Power Module, 0.12 kW (0.16 hp)
- SINAMICS CU240E-2 PN-F Control Unit
- IOP-2 operator panel
- SIMOTICS GP asynchronous (induction) motor with HTL encoder
- Simulator panel

The following expansions are possible:

- Second Power Module
- Various Control Units
- Servo module with load equipment and encoder system
- SIMATIC module

The SINAMICS G120 training case single-axis drive is supplied in the form of a trolley case. It is available in the basic and compact basic variants. The compact basic variant cannot be expanded with the SIMATIC module.

##### Technical specifications

	SINAMICS G120 training case single-axis drive	
	Basic 6AG1067-2AA00-0AA3	Compact basic 6AG1067-2AA00-0AB8
<b>Supply voltage</b>	1 AC 230 V	1 AC 230 V
<b>Dimensions</b>		
• Width	560 mm (22.05 in)	420 mm (16.54 in)
• Height	695 mm (27.36 in)	695 mm (27.36 in)
• Depth	325 mm (12.80 in)	325 mm (12.80 in)
<b>Weight, approx.</b>	28 kg (61.7 lb)	25 kg (55.1 lb)

##### Selection and ordering data

Description	Article No.
<b>SINAMICS G120 training case single-axis drive</b>	
• Basic	<b>6AG1067-2AA00-0AA3</b>
• Compact basic	<b>6AG1067-2AA00-0AB8</b>
<b>Accessories</b>	
<b>Power Module</b>	<b>6AG1067-2AA00-0AA5</b>
<b>SINAMICS G Control Units</b>	
• CU250S-2 PN	<b>6AG1067-2AA00-0AB7</b>
• CU240E-2 DP-F	<b>6AG1067-2AA00-0AA7</b>
• CU240E-2 PN-F	<b>6AG1067-2AA00-0AA8</b>
• CU230P-2 DP-F	<b>6AG1067-2AA00-0AB1</b>
<b>SINAMICS S Control Units</b>	
• CU310-2 DP	<b>6AG1067-2AA00-0AB3</b>
• CU310-2 PN	<b>6AG1067-2AA00-0AB4</b>
<b>SIMOTION D Control Unit</b>	
• D410-2	<b>6AG1067-2AA00-0AB5</b>
<b>Servo Module</b>	<b>6AG1067-2AA00-0AA4</b>
<b>SIMATIC Module</b>	<b>6AG1067-2AA00-0AA6</b>

## Accessories

### Power Module and Control Units

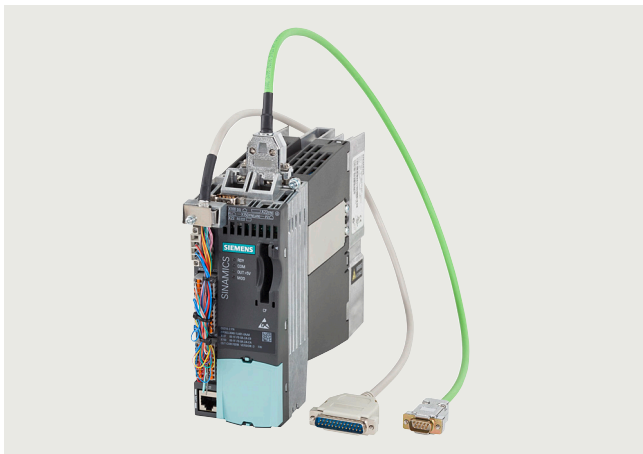

The Power Module expands the SINAMICS G120 training case single-axis drive with the functionality of a second converter. The PM240-2 Power Module is already pre-wired on the supply side.

The additional Control Units transform the SINAMICS G120 training case single-axis drive into a universal training case for SINAMICS and SIMOTION drive technology. The I/O signals are wired to SUB-D connectors.

#### SINAMICS G120 Control Units

CU250S-2 PN

CU240E-2 DP-F

CU240E-2 PN-F

CU230P-2 DP-F

#### SINAMICS S120 Control Units

CU310-2 DP

CU310-2 PN

#### SIMOTION D Control Unit

D410-2

### Servo Module

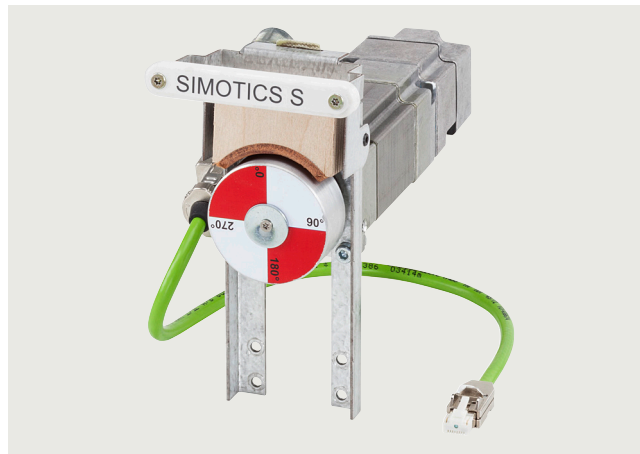

The servo module expands the SINAMICS G120 training case single-axis drive with servo functionality. The servo module comprises a SIMOTICS S-1FK7 servomotor with load equipment and a mounted mechanical system. The encoder cable is integrated into the servo module. The power cable is already included in the scope of supply of the SINAMICS G120 training case single-axis drive.

### SIMATIC Module



The SIMATIC module expands the SINAMICS G120 training case single-axis drive in the basic variant. The SIMATIC module supports integration of the SINAMICS G120 training case single-axis drive into the SIMATIC and TIA world. The SIMATIC S7-300/-1200/-1500 automation systems can be integrated.

## Services and documentation

### Control cabinets

#### Overview

##### **Complete equipment for machine tools and production systems**

Our supplied range of products and services also includes complete equipment for machine tools and production systems with all services in the process chain from consulting through to after-sales service.

We support you in the areas of engineering, production and logistics:

##### **Engineering support**

Siemens supports you with advice on design in accordance with standards and concepts for drive systems, control, operation and safety.

Our engineers configure for you in EPLAN P8 and other commonly used CAD systems, execute projects designed to cost and adapt your documents where necessary to UL or new systems.

Our Technical Competence Center Cabinets in Chemnitz supports you with selecting and optimizing the suitable control cabinet air-conditioning system. Apart from calculation and simulation, we also use instrumentation testing in our heat laboratory with load simulation.

We also offer the following services:

- Vibration measurements and control cabinet certification in the field
- Measurement of conducted interference voltages in our laboratory



Cabinet engineering

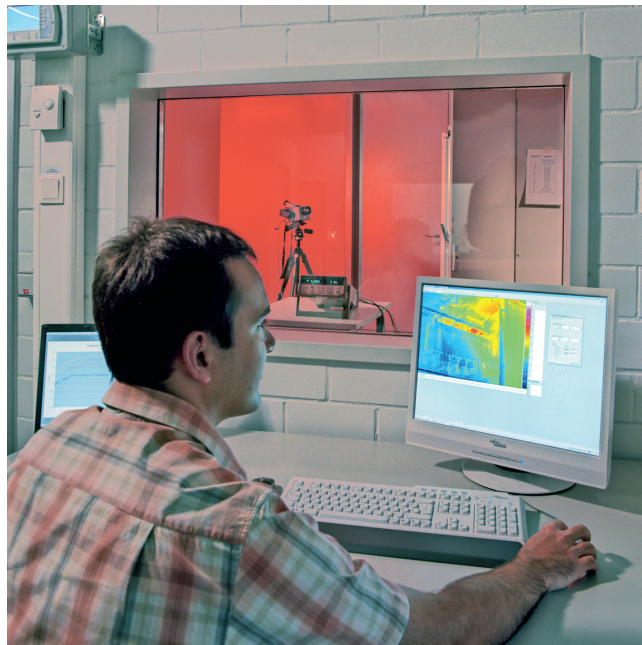

Testing in the heat laboratory

##### **Production at a high level of quality**

Complete equipment is manufactured at a high industrial level. This means:

- Examining consistency of the order documentation
- Checking for adherence to current regulations
- Collision check in 3D layout, taking into account the free space required thermally and electrically
- Automatic preparation of enclosures, cables and cable bundles
- Automated inspection and shipment free of faults
- Documentation and traceability
- Declaration of conformity regarding the Low-Voltage Directive and manufacturer's declaration on machinery directive
- UL label on request

##### **Superior logistics**

Everything from a single source offers you the following advantages:

- Cost savings for procurement, stockkeeping, financing
- Reduction in throughput times
- Just-in-time delivery

##### **Individual support and maximum flexibility**

Our technical consultants for complete equipment support customers and sales departments in the various regions. Our control cabinet customers are supported in the Systems Engineering Plant Chemnitz (WKC) by ordering centers and production teams that are permanently assigned to customers.

Distance does not present a problem; we also use web cams for consulting our customers.



**Overview**

Worldwide repair service

Customer-specific logistics models, flexible production capacity and production areas as well as change management in all process phases ensure maximum flexibility.

**Customized supplementary products**

As part of its complete equipment program, Siemens also offers the development and construction of customized supplementary products, e.g. special operator panels and power supply systems.

**Liability for defects**

Of course we accept the same liability for defects for our complete equipment as for our SINUMERIK and SINAMICS products.

Furthermore, you can use our worldwide repair service anywhere and at any time.

**Your benefits**

One partner, one quotation, one order, one delivery, one invoice, and one contact partner for liability of defects.

For series production or individual items, Siemens is your competent partner for complete equipment.



Control cabinet with SINAMICS S120 in booksize format

## Services and documentation

### Applications

#### Overview



Our understanding of an application is the customer-specific solution of an automation task based on standard hardware and software components. In this respect, industry knowledge and technological expertise are just as important as expert knowledge about how our products and systems work. We are setting ourselves this challenge with more than 280 application engineers in 20 countries.

#### Application centers

We currently have application centers in:

- Germany:
  - Head Office in Erlangen and in other German regions, e.g. in Munich, Nuremberg, Stuttgart, Mannheim, Frankfurt, Chemnitz, Cologne, Bielefeld, Bremen, Hanover, Hamburg
- Belgium: Brussels
- Brazil: Sao Paulo
- China: Beijing and 12 regions
- Denmark: Ballerup
- France: Paris
- Great Britain: Manchester
- India: Mumbai
- Italy: Bologna, Milan
- Japan: Tokyo, Osaka
- The Netherlands: The Hague
- Austria: Vienna
- Poland: Warsaw
- Sweden: Göteborg
- Switzerland: Zurich, Lausanne
- Spain: Madrid
- South Korea: Seoul
- Taiwan: Taipei
- Turkey: Istanbul
- USA: Atlanta

These application centers specialize in the use of SIMATIC/SIMOTION/SINAMICS. You therefore can rely on automation and drive specialists for implementing successful applications. By involving your personnel at an early stage in the process, we can provide a solid basis for rapid knowledge transfer, maintenance and further development of your automation solution.

#### Advice on applications and implementation

We offer a variety of consultation services to help you find the optimum solution for the SIMATIC/SIMOTION/SINAMICS application you want to implement:

The quotation phase includes

- clarification of technical questions,
- discussion of machine concepts and customer-specific solutions,
- selection of suitable technology and
- suggestions for implementation.

A technical feasibility study is also performed at the outset. In this way, difficult points of the application can be identified and solved early on. We can also configure and implement your application as a complete solution from a single source.

A large number of proven standard applications are available for use during the implementation phase. This saves engineering costs.

The system can be commissioned by experienced, competent personnel, if required. This saves time and trouble.

If servicing is required, we can support you on site or remotely. For further information about servicing, please see the section "Industry Services".

#### On-site application training

Training for the implemented applications can also be organized and carried out on site. This training for machine manufacturers and their customers does not deal with individual products, but the entire hardware and software system (for example, automation, drives and visualization).

From an initial concept to successful installation and commissioning: We provide complete support for SIMATIC/SIMOTION/SINAMICS! Contact your Siemens representative.

You can find further information at [www.siemens.com/machinebuilding](http://www.siemens.com/machinebuilding)

#### Overview

##### Efficient and cost-effective maintenance strategies for the entire product lifecycle



For you as an industry plant operator, maximum system productivity is your top priority.

Regular machine and plant maintenance performed by qualified service experts helps you ensure top plant performance for the long term.

For more information visit us at:  
[www.siemens.com/field-maintenance-services](http://www.siemens.com/field-maintenance-services)

#### General overhaul

#### Overview

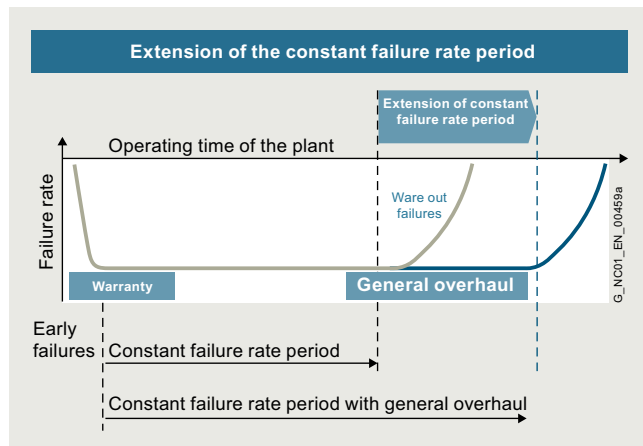

Extension of phases with a constant failure rate

Machines and plants are expected to have a long service life. The service life of electronic components and mechanical parts is, however, limited and normally shorter than the planned machine/plant operating times. For higher availability of the machines or plants, we offer a general overhaul (preventive maintenance) for electronic components and motors at favorable conditions.

During the planned general overhaul, wear parts and aging parts are replaced in accordance with their stated service life so as to reduce unplanned downtimes. In the case of motors, replacement of bearings and encoders is also offered in addition to a general overhaul.

If a fault is detected during a general overhaul, troubleshooting and repair will be performed after requesting confirmation.

In the case of severe wear or major damage, we offer an "as new" spare part instead of a general overhaul for reasons of quality.

#### Benefits

- Preventive replacement of wear parts and aging parts in accordance with their stated service life
- Reduction in unplanned plant stoppages
- Enhanced production reliability
- Extended availability of your machines/plants
- New liability for defects for 12 months for components which have undergone a general overhaul
- Low price

#### More information

You can find more information on the internet at:  
<https://support.industry.siemens.com/cs/sc/2120>

Contact information for your local Siemens office or national company is available on the internet at:  
[www.siemens.com/automation-contact](http://www.siemens.com/automation-contact)

#### Function check

#### Overview

A check is made to ensure that the components function reliably. The first step involves cleaning the components. After that, all hardware, software and firmware enhancements are implemented that are known to the development, production, suppliers, service and quality management departments. Using a comprehensive test concept of series production, all functions of the software, firmware, ASICs, and complex and less complex function blocks are checked.

If a fault is detected during an overhaul, troubleshooting and repair will be performed after requesting confirmation. In the case of severe wear or major damage, we offer an "as new" spare part.

#### Benefits

- The component is checked and can be deployed again
- The component contains all the known improvements
- The customer's own spare parts stock is up-to-date
- Low price

#### More information

You can find more information on the internet at:  
<https://support.industry.siemens.com/cs/sc/2122>

Contact information for your local Siemens office or national company is available on the internet at:  
[www.siemens.com/automation-contact](http://www.siemens.com/automation-contact)

## Services and documentation

### Spare parts services

#### Overview

##### *Be safe in an emergency – always the right spare part at hand*



Minimum downtimes and optimum use of staff and equipment are key to long-term success in industry.

But when a failure happens, it can bring the entire plant to a standstill in the worst case. Since even the best components will eventually reach the end of their lifecycle, our Spare Parts Services form the essential basis for smooth operation.

For more information visit us at:  
[www.siemens.com/spare-parts-services](http://www.siemens.com/spare-parts-services)

#### Delivery of spare parts

##### Overview

In every sector worldwide, plants and systems are required to operate with ever increasing availability. Not having a specific spare part at the right time can result in considerable costs.

We will provide you with the support you need to prevent a standstill from occurring in the first place: with a worldwide network and optimized logistics chains.

Order type	Logistics service	Remark
Standard	Cost-optimized: Contracted shipping company	Delivery within the normal national delivery times by the contracted shipping company
Plant downtime	Time-optimized: Express, courier, collection	You choose the shortest possible delivery time as it suits you best: <ul style="list-style-type: none"> <li>• Delivery by means of collection or courier service</li> <li>• Delivery by means of express delivery</li> </ul>
Emergency service	Special logistics: Courier	Spare parts can be ordered from us 24/7 – even outside normal working hours, as well as on weekends or national holidays. <ul style="list-style-type: none"> <li>• Delivery by means of courier service</li> </ul>

##### Benefits

- New liability for spare part defects
- Long-term spare parts availability
- Optimum system compatibility

##### More information

You can find more information on the internet at:  
<https://support.industry.siemens.com/cs/sc/2112>

Contact information for your local Siemens office or national company is available on the internet at:  
[www.siemens.com/automation-contact](http://www.siemens.com/automation-contact)

#### Overview

With many products, we also offer you the option of an exchange in addition to the simple delivery of spare parts. This has the advantage that you not only receive the spare part quickly, but are able to return the defective device to us for a credit. You therefore receive our spare part at the lower exchange price.

A credit will be awarded on condition that the repair code indicates that repurchasing is admissible, a replacement is obtained from the spare parts store, and that the returned product is repairable.

The order type and logistics service determine the delivery of spare parts:

Order type	Logistics service	Remark
Standard	Cost-optimized: Contracted shipping company	Delivery within the normal national delivery times by the contracted shipping company
Plant downtime	Time-optimized: Express, courier, collection	You choose the shortest possible delivery time as it suits you best: <ul style="list-style-type: none"> <li>• Delivery by means of collection or courier service</li> <li>• Delivery by means of express delivery</li> </ul>
Emergency service	Special logistics: Courier	Spare parts can be ordered from us 24/7 – even outside normal working hours, as well as on weekends or national holidays. <ul style="list-style-type: none"> <li>• Delivery by means of courier service</li> </ul>

#### Return

For product returns, we require the following information:

- Reason for return
- If defective: detailed description of the fault
- Machine number
- Machine/system manufacturer
- End user

We will then be able to provide you with additional information in the repair report/inspection report regarding the diagnosis/inspection as well as information about the completed repair.

#### Benefits

- Price benefits through the option of returning defective parts
- A spare part is available immediately in the event of failure
- New liability for spare part defects
- Long-term spare parts availability
- Optimum system compatibility

#### More information

You can find more information on the internet at:  
<https://support.industry.siemens.com/cs/sc/2112>

Contact information for your local Siemens office or national company is available on the internet at:  
[www.siemens.com/automation-contact](http://www.siemens.com/automation-contact)

#### Component upgrade service

#### Overview

##### **Upgrade service for components: From OLD to NEW**

Machines and plant are expected to have a long service life. The service life of the electronic components is, however, limited and normally shorter than the planned machine/plant operating times. To ensure that the required extended availability of the machines/plants is achieved, we offer an upgrade service for components at an attractive price.

In the course of their lifecycle, electronic components are normally redesigned/upgraded several times. With the upgrade service for components, you will always receive the latest technology.

A planned component upgrade from OLD to NEW helps to prevent unplanned machine stoppages and supports a safer and longer machines/plant availability. The upgrade service is mainly offered for older components that will soon be discontinued.

For information about the latest potential upgrades, please contact your local contact person. The upgrade service for components can only be offered to machine manufacturers or operators.

#### Benefits

- Price benefit through upgrade service
- New liability for new component defects
- Extended availability of your machines/plants
- Prevention of component failures due to wear and aging
- Prevention of machine stoppages due to unavailability of spare parts
- Reduced spare parts inventories
- Latest technology
- Easier servicing due to fewer variants
- Industry Services through Siemens are assured for the future

#### More information

You can find more information on the internet at:  
<https://support.industry.siemens.com/cs/sc/2112>

Contact information for your local Siemens office or national company is available on the internet at:  
[www.siemens.com/automation-contact](http://www.siemens.com/automation-contact)

## Services and documentation

### Spare parts services

#### Return of diagnostic parts

##### Overview

Spare parts used for diagnostic purposes from the spare parts store can be returned within 3 months and a credit note for up to 85% is issued.

For unused spare parts in their original packaging, you will receive a credit of 100% in which case you will be charged a fixed price for handling.

##### Benefits

- Can be used for diagnostics
- Reduced spare parts inventories
- Low costs

##### More information

You can find more information on the internet at: <https://support.industry.siemens.com/cs/sc/2112>

Contact information for your local Siemens office or national company is available on the internet at: [www.siemens.com/automation-contact](http://www.siemens.com/automation-contact)

#### Stock reduction in spare parts store

##### Overview

Fast spare part delivery by Siemens enables manufacturers and plant operators to reduce their spare part stocks. For this purpose, we offer an analysis that shows exactly which parts should remain in the customer warehouse for a particular machine stock and which can be purchased directly from Siemens.

##### Benefits

- Reduced costs
- Stock optimization
- Minimization of fault downtimes

##### More information

You can find more information on the internet at: <https://support.industry.siemens.com/cs/sc/2112>

Contact information for your local Siemens office or national company is available on the internet at: [www.siemens.com/automation-contact](http://www.siemens.com/automation-contact)

#### Extended spare part availability

##### Overview

We normally retain spare parts for all products and systems for a period of 10 years after discontinuation of product marketing.

In individual cases, when we do not carry spare parts, we will offer a repair.

For a wide range of products and systems, spare parts availability is extended. We can provide you with the current spare parts availability for your machines/plants as a service once you have registered online with identSNAPSHOT.

[www.siemens.com/identsnapshot](http://www.siemens.com/identsnapshot)

If you require longer availability of spare parts for your machines/plants, please contact your local contact person.

##### Benefits

- Higher plant availability
- Security of investment
- Reduction of lifecycle costs

##### More information

You can find more information on the internet at: <https://support.industry.siemens.com/cs/sc/2112>

Contact information for your local Siemens office or national company is available on the internet at: [www.siemens.com/automation-contact](http://www.siemens.com/automation-contact)

#### Overview

##### **High quality support in a breakdown – either at your premises or at a certified Siemens workshop**

Even the best components eventually reach the end of their lifecycle. The result: downtimes and reduced productivity.

Our Repair Services comprise all service tasks over the entire product lifecycle, from functional maintenance to increasing performance. In this way, our service experts analyze, repair, maintain and optimize your components at Siemens manufacturer level, so that costly downtimes are minimized.

For more information visit us at:  
[www.siemens.com/repair-services](http://www.siemens.com/repair-services)

Downtimes cause problems in the plant as well as unnecessary costs. We can help you to reduce both to a minimum – with our worldwide repair facilities. The advantages for you are: Defects can be rectified before they cause further harm.

Repair is a favorable option when you have specific reasons for not wanting to replace the defective device or part with a new one (delivery as exchange product).

We maintain a global network of Siemens repair shops and certified partners to ensure that we will always be able to process your repairs quickly.

We can offer you different types of repair depending on your requirements:

##### **Normal repair**

Normal repair at standard conditions normally takes 10 working days following receipt of the defective item at our repair shop.

##### **Fast repair**

In particularly urgent cases, we offer you the option of a fast repair within 1 or 2 working days for many products at additional cost.

##### **Mobile repair service**

We come to you and perform the required repairs on site, for example, when the device or component cannot be removed due to its weight.

##### **Function repair**

A function repair is the same as a normal repair but excludes the repair of cosmetic defects, e.g. scratches, inscriptions, discoloration. The conditions applicable to function repairs should be observed in this case. The function repair can only be offered to machine manufacturers or operators. Please contact your local contact person for more information.

##### **Long Life Repair**

As a rule, a spare parts and repair service is offered for electronics products for a period of up to ten years after the period of active marketing. After this time, these services are generally only available in the case of acknowledged warranty conditions. Not so at Siemens. The Long Life Repair Service is available for selected electronic products and standard motors. Siemens thus offers a complete solution that includes short delivery times, long availability of original spare parts, economical repairs and a service availability of up to 25 years.

#### Benefits

- Short downtimes for machines and plants
- Only certified original parts are used
- Additional services from Siemens:
  - Longer availability of your machine/plant through the early replacement of wear parts and aging parts
  - Highest standards of quality
  - Use of the comprehensive test concept of series production, including software, firmware, ASICs, complex function blocks, etc.
  - Implementation of all the hardware and software/firmware enhancements known from development, production, suppliers, and service and quality management departments.
- Information supplied by repair report/inspection report

#### More information

You can find more information on the internet at:  
<https://support.industry.siemens.com/cs/sc/3098>

Contact information for your local Siemens office or national company is available on the internet at:  
[www.siemens.com/automation-contact](http://www.siemens.com/automation-contact)

## Services and documentation

### Spares on Web

#### Overview

#### *Spares on Web – online identification of spare parts*

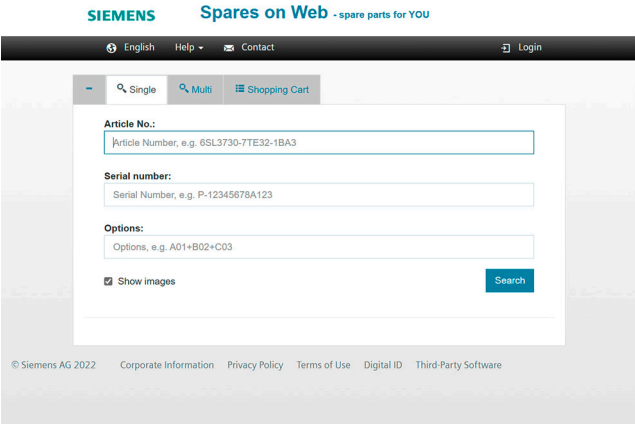

The screenshot displays the Siemens Spares on Web interface. At the top, the Siemens logo and the text "Spares on Web - spare parts for YOU" are visible. Below this, there is a navigation bar with "English", "Help", "Contact", and "Login" links. The main search area includes a search bar with "Single" and "Multi" options, and a "Shopping Cart" icon. The search form contains three input fields: "Article No." with a placeholder "Article Number, e.g. 6SL3730-7TE32-1BA3", "Serial number:" with a placeholder "Serial Number, e.g. P-12345678A123", and "Options:" with a placeholder "Options, e.g. A01+B02+C03". There is a "Show images" checkbox and a "Search" button. At the bottom of the page, there is a footer with "© Siemens AG 2022" and links for "Corporate Information", "Privacy Policy", "Terms of Use", "Digital ID", and "Third-Party Software".

Spares on Web is a web-based tool for identifying spare parts. After you have entered the Article No. and serial number, the spare parts available for the relevant unit are displayed.

[www.siemens.com/sow](http://www.siemens.com/sow)



## Overview

### Siemens Product Partner for Drives Options

#### Individual options for our drives

In order to meet as many customer requirements as possible in the field of drive technology, in addition to its own products, Siemens also relies on the individual and complementary services of selected partners.

We are increasingly focusing on the standard drive options, and our Siemens Product Partners for Drives Options supplement our drives with individual drive options.

This gives Siemens a unique flexibility to meet all application requirements. Naturally, we support our Siemens Product Partners for Drives Options in tailoring their options perfectly to our drives.

For you as our customer, there are multiple benefits:

- The Siemens Product Partners for Drives Options meet the same high standards of quality and performance that we place on our own products
- Drive options can be adapted to individual requirements/designs
- The Siemens Product Partners for Drives Options know our Siemens converter portfolio and can advise you individually and quickly

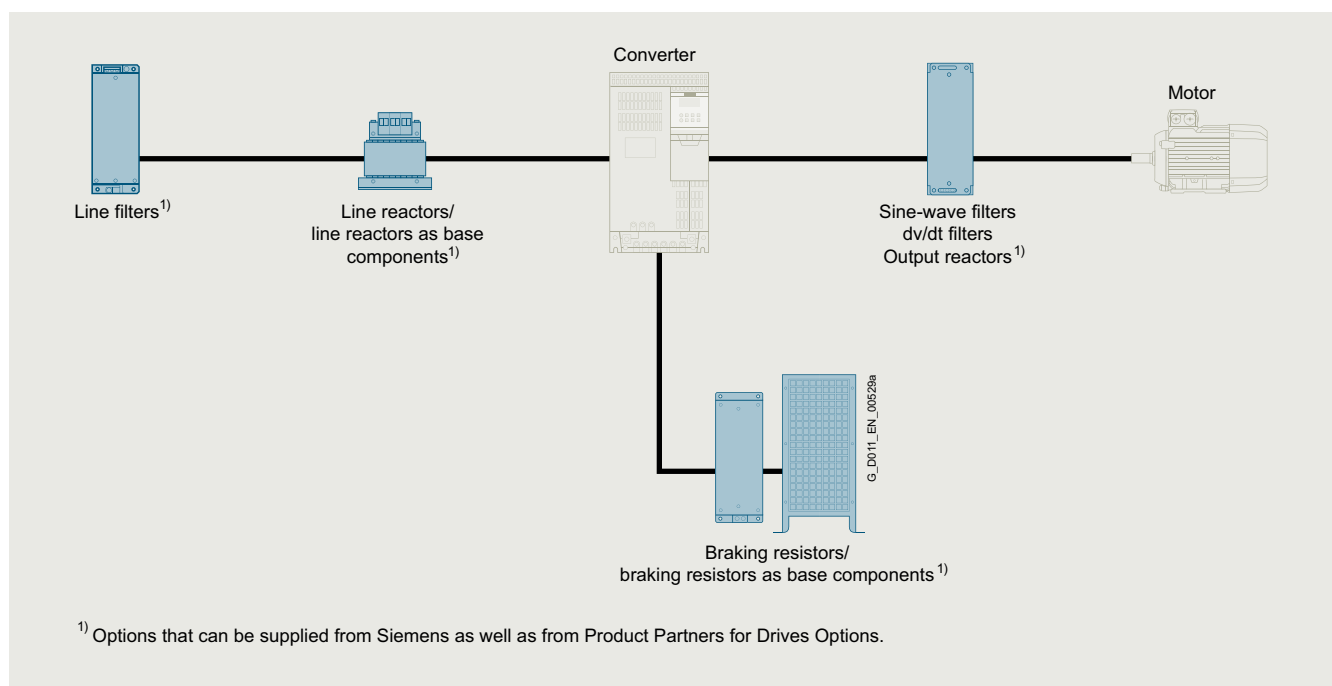

Schematic circuit diagram

## More Information

You can find more information on the internet at [www.siemens.com/drives-options-partner](http://www.siemens.com/drives-options-partner)

## Services and documentation

### mySupport documentation

#### Overview

### mySupport documentation – Compiling personal documents

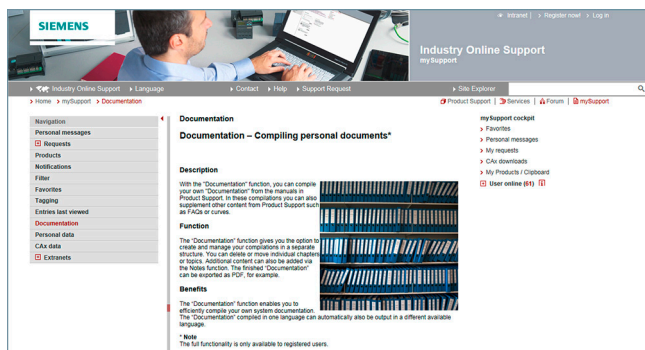

mySupport documentation is a web-based system for generating personalized documentation based on standard documents and is part of the Siemens Industry Online Support portal.

In mySupport, a personal document library can be created in the "Documentation" category. This library can be accessed online in mySupport or also be generated in various formats for offline use.

Previously, this functionality was available in the My Documentation Manager for configurable manuals. Due to the integration in mySupport, all entries of the Industry Online Support can now be imported into the personal document library, including FAQs or product notifications.

If you have already worked with the My Documentation Manager, all of the previously created libraries will continue to be available without restrictions in mySupport.

In addition, the personal library in mySupport can be shared with other mySupport users. In this way, a collection of relevant documents can be created very effectively and used together with other mySupport users all over the world.

You must register/log in for configuring and generating/managing.

#### Benefits

- Display  
View, print or download standard documents or personalized documents
- Configure  
Transfer standard documents or parts of them to personalized documents
- Generate/Manage  
Generate and manage personalized documents in the formats PDF, RTF or XML in all available languages

#### Function

##### Opening mySupport documentation in the Industry Online Support portal

- About the product support, entry type "Manual":  
<https://support.industry.siemens.com/cs/ww/en/ps/man>  
By clicking on the required version of the manual and then "Show and configure", the manual opens in a modular view, where you can navigate from topic to topic. Here the direct link to a topic can be used and made available to other users. The selected document can be added to the personal library via "mySupport Cockpit" > "Add to mySupport documentation".
- Via the direct link  
<https://support.industry.siemens.com/my/ww/en/documentation/advanced>  
After logon/registration, the online help is displayed as the current document.

#### More Information

You can find additional information on the internet at

- <https://support.industry.siemens.com/my/ww/en/documentation>
- [https://support.industry.siemens.com/cs/helpcenter/en/index.htm?#persoenliche\\_bibliothek\\_aufbauen.htm](https://support.industry.siemens.com/cs/helpcenter/en/index.htm?#persoenliche_bibliothek_aufbauen.htm)

## Overview

A high-quality programmable control or drive system can be used to maximum effect only if the user is aware of the performance of the products used as a result of intensive training and good technical documentation.

This is becoming more important due to the shorter innovation cycles of modern automation products and the convergence of electronics and mechanical engineering.

A comprehensive range of documentation is available which includes a Getting Started guide, operating instructions, installation manuals and a list manual.

The documents are available in hardcopy form or as a PDF file for downloading from the internet.

Information and documentation relating to SINUMERIK, SINAMICS, SIMOTION and SIMOTICS are available on the internet at <https://support.industry.siemens.com/cs/document/109476679>

## Application

### *Explanations of the manuals:*

- **Operating Instructions**  
contain all the information needed to install the device and make electrical connections, information about commissioning and a description of the converter functions.  
Phases of use: Control cabinet construction, commissioning, operation, maintenance and servicing.
- **Hardware Installation Manual**  
contains all relevant information about the intended use of the components of a system (technical specifications, interfaces, dimensional drawings, characteristics, or possible applications), information about installation and electrical connections and information about maintenance and servicing.  
Phases of use: Control cabinet configuration/construction, maintenance and servicing.
- **Operating and Installation Instructions** (for converter and accessories)  
contain all relevant information about the intended use of the components, such as technical specifications, interfaces, dimensional drawings, characteristics, or possible applications.  
Phases of use: Control cabinet configuration/construction.
- **Manual/Configuration Manual**  
contains all necessary information about the intended use of the components of a system, e.g. technical specifications, interfaces, dimensional drawings, characteristics, or possible applications.  
Phases of use: Cabinet configuration/setup, circuit diagram configuration/drawing.
- **Commissioning Manual**  
contains all information relevant to commissioning after installation and wiring. It also contains all safety and warning notices relevant to commissioning in addition to overview drawings.  
Phases of use: Commissioning of components that have already been connected, configuration of system functions.
- **List Manual**  
contains all parameters, function diagrams, and faults/alarms for the product/system as well as their meanings and setting options. It contains parameter data and fault/alarm descriptions with functional correlations.  
Phases of use: Commissioning of components that have already been connected, configuration of system functions, fault cause/diagnosis.
- **Getting Started**  
provides information about getting started for the first-time user as well as references to additional information. It contains information about the basic steps to be taken during commissioning. The information in the other documentation should be carefully observed for all of the other work required.  
Phases of use: Commissioning of components that have already been connected.
- **Function Manual Drive Functions**  
contains all the relevant information about individual drive functions: Description, commissioning and integration in the drive system.  
Phases of use: Commissioning of components that have already been connected, configuration of system functions.

## Services and documentation

### Notes

## Appendix



15/2	<b>Certificates of suitability</b>
15/4	<b>Software licenses</b>
15/6	<b>Conversion tables</b>
15/9	<b>Conditions of sale and delivery/</b>

## Appendix

### Certificates of suitability







#### Overview

Many of the products in this Catalog fulfill requirements, e.g. for UL, CSA or FM and are labeled with the corresponding approval designation.





All of the certificates of suitability, approvals, certificates, declarations of conformity, test certificates, e.g. CE, UL, Safety Integrated etc. have been performed with the associated system components as they are described in the Catalogs and Configuration Manuals.

The certificates are only valid if the products are used with the described system components, are installed according to the Installation Guidelines and used for their intended purpose.

In other cases, the vendor of these products is responsible for arranging for the issue of new certificates.

Test code	Tested by	Device series/ Component	Test standard	Product category/ File-No.
<b>UL: Underwriters Laboratories</b> <i>Independent public testing body in North America</i>				
	UL according to UL standard	SINUMERIK	Standard UL 508, CSA C22.2 No. 142	NRAQ/7.E164110 NRAQ/7.E217227
		SIMOTION	Standard UL 508, CSA C22.2 No. 142	NRAQ/7.E164110
	UL according to CSA standard	SINAMICS	Standard UL 508, 508C, 61800-5-1 CSA C22.2 No. 142, 274	NRAQ/7.E164110, NMMS/2/7/8.E192450, NMMS/2/7/8.E203250, NMMS/7.E214113, NMMS/7.E253831
	UL according to UL and CSA standards			NMMS/2/7/8.E121068 NMMS/7.E355661 NMMS/7.E323473
	UL according to UL standard	SIMODRIVE	Standard UL 508C, CSA C22.2 No. 274	NMMS/2/7/8.E192450 NMMS/7.E214113
		SIMOTICS	Standard UL 1004-1, 1004-6, 1004-8, CSA C22.2 No. 100	PRGY2/8.E227215 PRHZ2/8.E93429 PRHJ2/8.E342747 PRGY2/8.E253922 PRHZ2/8.E342746
	UL according to CSA standard			
	UL according to UL and CSA standard			
		Line/motor reactors	Standard UL 508, 506, 5085-1, 5085-2, 1561, CSA C22.2 No. 14, 47, 66.1-06, 66.2-06	XQNX2/8.E257859 NMTR2/8.E219022 NMMS2/8.E333628 XPTQ2/8.E257852 XPTQ2/8.E103521 NMMS2/8.E224872 XPTQ2/8.E354316 XPTQ2/8.E198309 XQNX2/8.E475972
		Line filters, dv/dt filters, sine-wave filters	UL 1283, CSA C22.2 No. 8	FOKY2/8.E70122
		Resistors	UL 508, 508C, CSA C22.2 No. 14, 274	NMTR2/8.E224314 NMMS2/8.E192450 NMTR2/8.E221095 NMTR2/8.E226619
<b>TUV: TÜV Rheinland of North America Inc.</b> <i>Independent public testing body in North America, Nationally Recognized Testing Laboratory (NRTL)</i>				
<b>TÜV: TÜV SÜD Product Service</b> <i>Independent public testing body in Germany, Nationally Recognized Testing Laboratory (NRTL) for North America</i>				
	TUV according to UL and CSA standards	SINAMICS	NRTL Listing according to standard UL 508C	U7V 12 06 20078 013 U7 11 04 20078 009 U7 11 04 20078 010 U7 11 04 20078 011
		SIMOTION	NRTL Listing according to standard UL 508	U7V 13 03 20078 01
		SIMODRIVE	NRTL Listing according to standard UL 508C, CSA C22.2. No. 14	CU 72090702
		Motion Control Encoder	NRTL Listing according to UL 61010-1 CSA C22.2 No. 61010-1	U8V 10 06 20196 024

## Overview

Test code	Tested by	Device series/ Component	Test standard	Product category/ File-No.
<b>CSA: Canadian Standards Association</b> <i>Independent public testing body in Canada</i>				
	CSA according to CSA standard	SINUMERIK	Standard CSA C22.2 No. 142	2252-01 : LR 102527
<b>FMRC: Factory Mutual Research Corporation</b> <i>Independent public testing body in North America</i>				
	FM according to FM standard	SINUMERIK	Standard FMRC 3600, FMRC 3611, FMRC 3810, ANSI/ISA S82.02.1	–
<b>EAC: Ivanovo-Certificate</b> <i>Independent public testing body in the Russian Federation</i>				
	EAC in accordance with EAC Directive	SINAMICS SINUMERIK SIMOTION	Standard IEC 61800-5-1/-2, IEC 61800-3	–
<b>RCM: Australian Communications and Media Authority</b> <i>Independent public testing body in Australia</i>				
	RCM according to EMV standard	SINAMICS SINUMERIK SIMOTION	Standard IEC AS 61800-3, EN 61800-3	–
<b>KC: National Radio Research Agency</b> <i>Independent public testing body in South Korea</i>				
	KC according to EMV standard	SINAMICS SINUMERIK SIMOTION	Standard KN 11	–
<b>BIA</b> <i>Federal Institute for Occupational Safety</i>				
–	Functional safety	SINAMICS SINUMERIK SIMOTION	Standard EN 61800-5-2	–
<b>TÜV SÜD Rail</b>				
–	Functional safety	SINAMICS SINUMERIK SIMOTION	Standard EN 61800-5-2	–

More information about certificates can be found online at:  
<https://support.industry.siemens.com/cs/ww/en/ps/cert>

## Appendix

### Software licenses

#### Overview

##### Software types

Software requiring a license is categorized into types. The following software types have been defined:

- Engineering software
- Runtime software

##### Engineering software

This includes all software products for creating (engineering) user software, e.g. for configuring, programming, parameterizing, testing, commissioning or servicing.

Data generated with engineering software and executable programs can be duplicated for your own use or for use by third-parties free-of-charge.

##### Runtime software

This includes all software products required for plant/machine operation, e.g. operating system, basic system, system expansions, drivers, etc.

The duplication of the runtime software and executable programs created with the runtime software for your own use or for use by third-parties is subject to a charge.

You can find information about license fees according to use in the ordering data (e.g. in the catalog). Examples of categories of use include per CPU, per installation, per channel, per instance, per axis, per control loop, per variable, etc.

Information about extended rights of use for parameterization/configuration tools supplied as integral components of the scope of supply can be found in the readme file supplied with the relevant product(s).

##### License types

Siemens Industry Automation & Drive Technologies offers various types of software license:

- Floating license
- Single license
- Rental license
- Rental floating license
- Trial license
- Demo license
- Demo floating license

##### Floating license

The software may be installed for internal use on any number of devices by the licensee. Only the concurrent user is licensed. The concurrent user is the person using the program. Use begins when the software is started. A license is required for each concurrent user.

##### Single license

Unlike the floating license, a single license permits only one installation of the software per license.

The type of use licensed is specified in the ordering data and in the Certificate of License (CoL). Types of use include for example per instance, per axis, per channel, etc.

One single license is required for each type of use defined.

##### Rental license

A rental license supports the "sporadic use" of engineering software. Once the license key has been installed, the software can be used for a specific period of time (the operating hours do not have to be consecutive).

One license is required for each installation of the software.

##### Rental floating license

The rental floating license corresponds to the rental license, except that a license is not required for each installation of the software. Rather, one license is required per object (for example, user or device).

##### Trial license

A trial license supports "short-term use" of the software in a non-productive context, e.g. for testing and evaluation purposes. It can be transferred to another license.

##### Demo license

The demo license support the "sporadic use" of engineering software in a non-productive context, for example, use for testing and evaluation purposes. It can be transferred to another license. After the installation of the license key, the software can be operated for a specific period of time, whereby usage can be interrupted as often as required.

One license is required per installation of the software.

##### Demo floating license

The demo floating license corresponds to the demo license, except that a license is not required for each installation of the software. Rather, one license is required per object (for example, user or device).

##### Certificate of License (CoL)

The CoL is the licensee's proof that the use of the software has been licensed by Siemens. A CoL is required for every type of use and must be kept in a safe place.

##### Downgrading

The licensee is permitted to use the software or an earlier version/release of the software, provided that the licensee owns such a version/release and its use is technically feasible.

##### Delivery versions

Software is constantly being updated. The following delivery versions

- PowerPack
- Upgrade

can be used to access updates.

Existing bug fixes are supplied with the ServicePack version.

##### PowerPack

PowerPacks can be used to upgrade to more powerful software. The licensee receives a new license agreement and CoL (Certificate of License) with the PowerPack. This CoL, together with the CoL for the original product, proves that the new software is licensed.

A separate PowerPack must be purchased for each original license of the software to be replaced.

##### Upgrade

An upgrade permits the use of a new version of the software on the condition that a license for a previous version of the product is already held.

The licensee receives a new license agreement and CoL with the upgrade. This CoL, together with the CoL for the previous product, proves that the new version is licensed.

A separate upgrade must be purchased for each original license of the software to be upgraded.



## Overview

### **ServicePack**

ServicePacks are used to debug existing products. ServicePacks may be duplicated for use as prescribed according to the number of existing original licenses.

### **License key**

Siemens Industry Automation & Drive Technologies supplies software products with and without license keys.

The license key serves as an electronic license stamp and is also the "switch" for activating the software (floating license, rental license, etc.).

The complete installation of software products requiring license keys includes the program to be licensed (the software) and the license key (which represents the license).

### **Software Update Service (SUS)**

As part of the SUS contract, all software updates for the respective product are made available to you free of charge for a period of one year from the invoice date. The contract will automatically be extended for one year if it is not canceled three months before it expires.

The possession of the current version of the respective software is a basic condition for entering into an SUS contract.

You can download explanations concerning license conditions from [https://mall.industry.siemens.com/legal/ww/en/terms\\_of\\_trade\\_en.pdf](https://mall.industry.siemens.com/legal/ww/en/terms_of_trade_en.pdf)

## Appendix

### Conversion tables

**Rotary inertia** (to convert from A to B, multiply by entry in table)

A \ B	lb-in <sup>2</sup>	lb-ft <sup>2</sup>	lb-in-s <sup>2</sup>	lb-ft-s <sup>2</sup> slug-ft <sup>2</sup>	kg-cm <sup>2</sup>	kg-cm-s <sup>2</sup>	gm-cm <sup>2</sup>	gm-cm-s <sup>2</sup>	oz-in <sup>2</sup>	oz-in-s <sup>2</sup>
lb-in <sup>2</sup>	1	$6.94 \times 10^{-3}$	$2.59 \times 10^{-3}$	$2.15 \times 10^{-4}$	2.926	$2.98 \times 10^{-3}$	$2.92 \times 10^3$	2.984	16	$4.14 \times 10^{-2}$
lb-ft <sup>2</sup>	144	1	0.3729	$3.10 \times 10^{-2}$	421.40	0.4297	$4.21 \times 10^5$	429.71	2304	5.967
lb-in-s <sup>2</sup>	386.08	2.681	1	$8.33 \times 10^{-2}$	$1.129 \times 10^3$	1.152	$1.129 \times 10^6$	$1.152 \times 10^3$	$6.177 \times 10^3$	16
lb-ft-s <sup>2</sup> slug-ft <sup>2</sup>	$4.63 \times 10^3$	32.17	12	1	$1.35 \times 10^4$	13.825	$1.355 \times 10^7$	$1.38 \times 10^4$	$7.41 \times 10^4$	192
kg-cm <sup>2</sup>	0.3417	$2.37 \times 10^{-3}$	$8.85 \times 10^{-4}$	$7.37 \times 10^{-5}$	1	$1.019 \times 10^{-3}$	1000	1.019	5.46	$1.41 \times 10^{-2}$
kg-cm-s <sup>2</sup>	335.1	2.327	0.8679	$7.23 \times 10^{-2}$	980.66	1	$9.8 \times 10^5$	1000	$5.36 \times 10^3$	13.887
gm-cm <sup>2</sup>	$3.417 \times 10^{-4}$	$2.37 \times 10^{-6}$	$8.85 \times 10^{-7}$	$7.37 \times 10^{-8}$	$1 \times 10^{-3}$	$1.01 \times 10^{-6}$	1	$1.01 \times 10^{-3}$	$5.46 \times 10^{-3}$	$1.41 \times 10^{-5}$
gm-cm-s <sup>2</sup>	0.335	$2.32 \times 10^{-3}$	$8.67 \times 10^{-4}$	$7.23 \times 10^{-5}$	0.9806	$1 \times 10^{-3}$	980.6	1	5.36	$1.38 \times 10^{-2}$
oz-in <sup>2</sup>	0.0625	$4.34 \times 10^{-4}$	$1.61 \times 10^{-4}$	$1.34 \times 10^{-5}$	0.182	$1.86 \times 10^{-4}$	182.9	0.186	1	$2.59 \times 10^{-3}$
oz-in-s <sup>2</sup>	24.13	0.1675	$6.25 \times 10^{-2}$	$5.20 \times 10^{-3}$	70.615	$7.20 \times 10^{-2}$	$7.09 \times 10^4$	72.0	386.08	1

**Torque** (to convert from A to B, multiply by entry in table)

A \ B	lb-in	lb-ft	oz-in	N-m	kg-cm	kg-m	gm-cm	dyne-cm
lb-in	1	$8.333 \times 10^{-2}$	16	0.113	1.152	$1.152 \times 10^{-2}$	$1.152 \times 10^3$	$1.129 \times 10^6$
lb-ft	12	1	192	1.355	13.825	0.138	$1.382 \times 10^4$	$1.355 \times 10^7$
oz-in	$6.25 \times 10^{-2}$	$5.208 \times 10^{-3}$	1	$7.061 \times 10^{-3}$	$7.200 \times 10^{-2}$	$7.200 \times 10^{-4}$	72.007	$7.061 \times 10^4$
N-m	8.850	0.737	141.612	1	10.197	0.102	$1.019 \times 10^4$	$1 \times 10^7$
kg-cm	0.8679	$7.233 \times 10^{-2}$	13.877	$9.806 \times 10^{-2}$	1	$10^{-2}$	1000	$9.806 \times 10^5$
kg-m	86.796	7.233	$1.388 \times 10^3$	9.806	100	1	$1 \times 10^5$	$9.806 \times 10^7$
gm-cm	$8.679 \times 10^{-4}$	$7.233 \times 10^{-5}$	$1.388 \times 10^{-2}$	$9.806 \times 10^{-5}$	$1 \times 10^{-3}$	$1 \times 10^{-5}$	1	980.665
dyne-cm	$8.850 \times 10^{-7}$	$7.375 \times 10^{-8}$	$1.416 \times 10^{-5}$	$10^{-7}$	$1.0197 \times 10^{-6}$	$1.019 \times 10^{-8}$	$1.019 \times 10^{-3}$	1

**Length** (to convert from A to B, multiply by entry in table)

A \ B	inches	feet	cm	yd	mm	m
inches	1	0.0833	2.54	0.028	25.4	0.0254
feet	12	1	30.48	0.333	304.8	0.3048
cm	0.3937	0.03281	1	$1.09 \times 10^{-2}$	10	0.01
yd	36	3	91.44	1	914.4	0.914
mm	0.03937	0.00328	0.1	$1.09 \times 10^{-3}$	1	0.001
m	39.37	3.281	100	1.09	1000	1

**Force** (to convert from A to B, multiply by entry in table)

A \ B	lb	oz	gm	dyne	N
lb	1	16	453.6	$4.448 \times 10^5$	4.4482
oz	0.0625	1	28.35	$2.780 \times 10^4$	0.27801
gm	$2.205 \times 10^{-3}$	0.03527	1	$1.02 \times 10^{-3}$	N.A.
dyne	$2.248 \times 10^{-6}$	$3.59 \times 10^{-5}$	980.7	1	0.00001
N	0.22481	3.5967	N.A.	100000	1

**Mass** (to convert from A to B, multiply by entry in table)

A \ B	lb	oz	gm	kg	slug
lb	1	16	453.6	0.4536	0.0311
oz	$6.25 \times 10^{-2}$	1	28.35	0.02835	$1.93 \times 10^{-3}$
gm	$2.205 \times 10^{-3}$	$3.527 \times 10^{-2}$	1	$10^{-3}$	$6.852 \times 10^{-5}$
kg	2.205	35.27	$10^3$	1	$6.852 \times 10^{-2}$
slug	32.17	514.8	$1.459 \times 10^4$	14.59	1

**Power** (to convert from A to B, multiply by entry in table)

A \ B	hp	Watts
hp (English)	1	745.7
(lb-in) (deg./s)	$2.645 \times 10^{-6}$	$1.972 \times 10^{-3}$
(lb-in) (rpm)	$1.587 \times 10^{-5}$	$1.183 \times 10^{-2}$
(lb-ft) (deg./s)	$3.173 \times 10^{-5}$	$2.366 \times 10^{-2}$
(lb-ft) (rpm)	$1.904 \times 10^{-4}$	0.1420
Watts	$1.341 \times 10^{-3}$	1

**Rotation** (to convert from A to B, multiply by entry in table)

A \ B	rpm	rad/s	degrees/s
rpm	1	0.105	6.0
rad/s	9.55	1	57.30
degrees/s	0.167	$1.745 \times 10^{-2}$	1

**Temperature Conversion**

°F	°C	°C	°F
0	-17.8	-10	14
32	0	0	32
50	10	10	50
70	21.1	20	68
90	32.2	30	86
98.4	37	37	98.4
212	100	100	212
subtract 32 and multiply by $\frac{5}{9}$		multiply by $\frac{9}{5}$ and add 32	

**Mechanism Efficiencies**

Acme-screw with brass nut	~0.35–0.65
Acme-screw with plastic nut	~0.50–0.85
Ball-screw	~0.85–0.95
Chain and sprocket	~0.95–0.98
Preloaded ball-screw	~0.75–0.85
Spur or bevel-gears	~0.90
Timing belts	~0.96–0.98
Worm gears	~0.45–0.85
Helical gear (1 reduction)	~0.92

**Friction Coefficients**

Materials	$\mu$
Steel on steel (greased)	~0.15
Plastic on steel	~0.15–0.25
Copper on steel	~0.30
Brass on steel	~0.35
Aluminum on steel	~0.45
Steel on steel	~0.58
Mechanism	$\mu$
Ball bushings	<0.001
Linear bearings	<0.001
Dove-tail slides	~0.2++
Gibb ways	~0.5++

**Material Densities**

Material	lb-in <sup>3</sup>	gm-cm <sup>3</sup>
Aluminum	0.096	2.66
Brass	0.299	8.30
Bronze	0.295	8.17
Copper	0.322	8.91
Hard wood	0.029	0.80
Soft wood	0.018	0.48
Plastic	0.040	1.11
Glass	0.079–0.090	2.2–2.5
Titanium	0.163	4.51
Paper	0.025–0.043	0.7–1.2
Polyvinyl chloride	0.047–0.050	1.3–1.4
Rubber	0.033–0.036	0.92–0.99
Silicone rubber, without filler	0.043	1.2
Cast iron, gray	0.274	7.6
Steel	0.280	7.75

**Wire Gauges<sup>1)</sup>**

Cross-section mm <sup>2</sup>	Standard Wire Gauge (SWG)	American Wire Gauge (AWG)
0.2	25	24
0.3	23	22
0.5	21	20
0.75	20	19
1.0	19	18
1.5	17	16
2.5	15	13
4	13	11
6	12	9
10	9	7
16	7	6
25	5	3
35	3	2
50	0	1/0
70	000	2/0
95	00000	3/0
120	0000000	4/0
150	–	6/0
185	–	7/0

1) The table shows approximate SWG/AWG sizes nearest to standard metric sizes; the cross-sections do not match exactly.

## Appendix

### Conditions of sale and delivery

#### 1. General Provisions

By using this catalog you can purchase products (hardware, software and services) described therein from Siemens Aktiengesellschaft subject to the following Terms and Conditions of Sale and Delivery (hereinafter referred to as "T&C"). Please note that the scope, the quality and the conditions for supplies and services, including software products, by any Siemens entity having a registered office outside Germany, shall be subject exclusively to the General Terms and Conditions of the respective Siemens entity. The following T&C apply exclusively for orders placed with Siemens Aktiengesellschaft, Germany.

##### 1.1 For customers with a seat or registered office in European Union

For customers with a seat or registered office in European Union, the following terms and conditions apply subordinate to T&C:

- for products, which include specific terms and conditions in the description text, these specific terms and conditions shall apply and subordinate thereto,
- for stand-alone software products and software products forming a part of a product or project, the "General License Conditions for Software Products for Automation and Drives for Customers with a Seat or registered Office in Germany"<sup>1)</sup> and/or
- for consulting services the "Allgemeine Geschäftsbedingungen für Beratungsleistungen der Division DF – Deutschland" (available only in German) and/or
- for other services, the „Supplementary Terms and Conditions for Services ("BL")"<sup>1)</sup> and/or
- for other supplies the "General Conditions for the Supply of Products and Services of the Electrical and Electronics Industry"<sup>1)</sup>.

In case such supplies should contain Open Source Software, the conditions of which shall prevail over the "General Conditions for the Supply of Products and Services of the Electrical and Electronics Industry"<sup>1)</sup>, a notice will be contained in the scope of delivery in which the applicable conditions for Open Source Software are specified. This shall apply mutatis mutandis for notices referring to other third party software components.

##### 1.2 For customers with a seat or registered office outside European Union

For customers with a seat or registered office outside European Union, the following terms and conditions apply subordinate to T&C:

- for products, which include specific terms and conditions in the description text, these specific terms and conditions shall apply and subordinate thereto,
- for consulting services the "Standard Terms and Conditions for Consulting Services of the Division DF for Customers with a Seat or Registered Office Outside of Germany"<sup>1)</sup> and/or
- for other services the "International Terms & Conditions for Services"<sup>1)</sup> supplemented by "Software Licensing Conditions"<sup>1)</sup> and/or
- for other supplies of hard- and software the "International Terms & Conditions for Products"<sup>1)</sup> supplemented by "Software Licensing Conditions"<sup>1)</sup>

##### 1.3 For customers with master or framework agreement

To the extent our supplies and/or services offered are covered by an existing master or framework agreement, the terms and conditions of that agreement shall apply instead of T&C.

#### 2. Prices

The prices are in € (Euro) ex point of delivery, exclusive of packaging.

The sales tax (value added tax) is not included in the prices. It shall be charged separately at the respective rate according to the applicable statutory legal regulations.

Prices are subject to change without prior notice. We will charge the prices valid at the time of delivery.

To compensate for variations in the price of raw materials (e.g. silver, copper, aluminum, lead, gold, dysprosium and neodym), surcharges are calculated on a daily basis using the so-called metal factor for products containing these raw materials.

A surcharge for the respective raw material is calculated as a supplement to the price of a product if the basic official price of the raw material in question is exceeded.

The metal factor of a product indicates the basic official price (for those raw materials concerned) as of which the surcharges on the price of the product are applied, and with what method of calculation.

An exact explanation of the metal factor can be downloaded at: [https://mall.industry.siemens.com/legal/ww/en/terms\\_of\\_trade\\_en.pdf](https://mall.industry.siemens.com/legal/ww/en/terms_of_trade_en.pdf)

To calculate the surcharge (except in the cases of dysprosium and neodym), the official price from the day prior to that on which the order was received or the release order was effected is used.

To calculate the surcharge applicable to dysprosium and neodym ("rare earths"), the corresponding three-month basic average price in the quarter prior to that in which the order was received or the release order was effected is used with a one-month buffer (details on the calculation can be found in the explanation of the metal factor).

#### 3. Additional Terms and Conditions

The dimensions are in mm. In Germany, according to the German law on units in measuring technology, data in inches apply only to devices for export.

Illustrations are not binding.

Insofar as there are no remarks on the individual pages of this catalog – especially with regard to data, dimensions and weights given – these are subject to change without prior notice.

<sup>1)</sup> The text of the Terms and Conditions of Siemens AG can be downloaded at [https://mall.industry.siemens.com/legal/ww/en/terms\\_of\\_trade\\_en.pdf](https://mall.industry.siemens.com/legal/ww/en/terms_of_trade_en.pdf)

### 4. Export Regulations

We shall not be obligated to fulfill any agreement if such fulfillment is prevented by any impediments arising out of national or international foreign trade or customs requirements or any embargoes and/or other sanctions.

Export may be subject to license. We shall indicate in the delivery details whether licenses are required under German, European and US export lists.

Our products are controlled by the U.S. Government (when labeled with "ECCN" unequal "N") and authorized for export only to the country of ultimate destination for use by the ultimate consignee or end-user(s) herein identified. They may not be resold, transferred, or otherwise disposed of, to any other country or to any person other than the authorized ultimate consignee or end-user(s), either in their original form or after being incorporated into other items, without first obtaining approval from the U.S. Government or as otherwise authorized by U.S. law and regulations. Products labeled with "AL" unequal "N" are subject to European / national export authorization.

The export indications can be viewed in advance in the description of the respective goods on the Industry Mall, our online catalog system. Only the export labels "AL" and "ECCN" indicated on order confirmations, delivery notes and invoices are authoritative.

Products without label, with label "AL:N" / "ECCN:N", or label "AL:9X9999" / "ECCN: 9X9999" may require authorization from responsible authorities depending on the final end-use, or the destination.

If you transfer goods (hardware and/or software and/or technology as well as corresponding documentation, regardless of the mode of provision) delivered by us or works and services (including all kinds of technical support) performed by us to a third party worldwide, you shall comply with all applicable national and international (re-)export control regulations. In any event of such transfer of goods, works and services you shall comply with the (re-) export control regulations of the Federal Republic of Germany, of the European Union and of the United States of America.

Prior to any transfer of goods, works and services provided by us to a third party you shall in particular check and guarantee by appropriate measures that

- there will be no infringement of an embargo imposed by the European Union, by the United States of America and/ or by the United Nations by such transfer, by brokering of contracts concerning those goods, works and services or by provision of other economic resources in connection with those goods, works and services, also considering the limitations of domestic business and prohibitions of by-passing those embargoes;
- such goods, works and services are not intended for use in connection with armaments, nuclear technology or weapons, if and to the extent such use is subject to prohibition or authorization, unless required authorization is provided;
- the regulations of all applicable Sanctioned Party Lists of the European Union and the United States of America concerning the trading with entities, persons and organizations listed therein are considered.

If required to enable authorities or us to conduct export control checks, you, upon request by us, shall promptly provide us with all information pertaining to the particular end customer, the particular destination and the particular intended use of goods, works and services provided by us, as well as any export control restrictions existing.

You acknowledge that under the EU embargo regulations against Iran, Syria and Russia respectively the sale of certain listed goods and related services is subject to authorization by the competent export control authorities of the European Union. If (i) the goods or services ordered by you are destined for Iran, Syria or Russia, and (ii) the contract for our supplies and/or services is subject to prior authorization of the competent export control authorities of the European Union, the contract between you and us shall come into force in this respect only upon granting of such authorization.

The products listed in this catalog may be subject to European/German and/or US export regulations. Any export requiring approval is therefore subject to authorization by the relevant authorities.

Errors excepted and subject to change without prior notice.

## Appendix

### Notes

## Selection and ordering at Siemens Industry Mall and downloading catalogs

### Easy product selection and ordering: Industry Mall

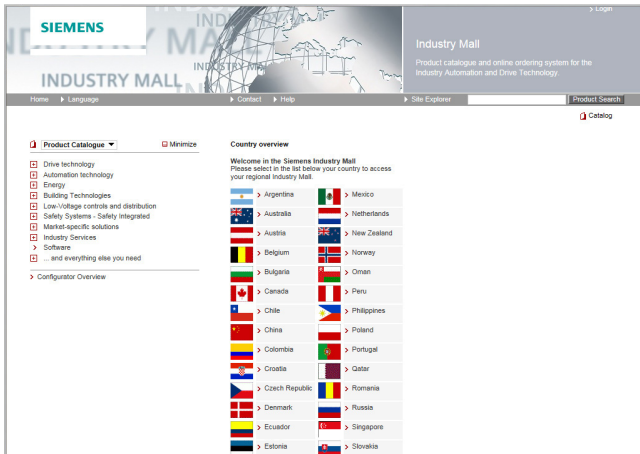

### Industry Mall

The Industry Mall is a Siemens AG Internet ordering platform. It provides you with online access to a comprehensive product spectrum that is presented in an informative, well-organized way.

Powerful search functions help you select the required products, while configurators enable you to configure complex product and system components quickly and easily. CAx data are also available for you to use.

Data transfer allows the entire procedure, from selection through ordering to tracking and tracing, to be carried out online. Availability checks, individual customer discounting, and quotation preparation are also possible.

[www.siemens.com/industrymall](http://www.siemens.com/industrymall)

### Downloading catalogs

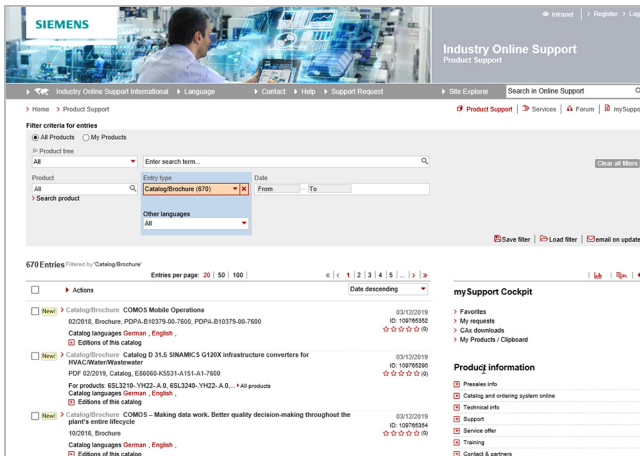

### Siemens Industry Online Support

You can download catalogs and brochures in PDF format from Siemens Industry Online Support without having to register.

The filter box makes it possible to perform targeted searches.

[www.siemens.com/industry-catalogs](http://www.siemens.com/industry-catalogs)

## Get more information

The SINAMICS converter family:

[www.siemens.com/sinamics](http://www.siemens.com/sinamics)

SIMOTICS electric motors:

[www.siemens.com/simotics](http://www.siemens.com/simotics)

SIMOGEAR servo geared motors:

[www.siemens.com/simogear](http://www.siemens.com/simogear)

Motion Control Systems and Solutions for production machine and machine tool equipment:

[www.siemens.com/motioncontrol](http://www.siemens.com/motioncontrol)

Local partners worldwide:

[www.siemens.com/automation-contact](http://www.siemens.com/automation-contact)

Published by  
Siemens AG

Digital Industries  
Motion Control  
Postfach 31 80  
91050 Erlangen, Germany

For the U.S. published by  
Siemens Industry Inc.

100 Technology Drive  
Alpharetta, GA 30005  
United States

PDF (E86060-K5531-A111-A4-7600)  
V6.MKKATA.GMC.100  
KG 0523 388 En  
Produced in Germany  
© Siemens 2023

## Security information

Siemens provides products and solutions with industrial security functions that support the secure operation of plants, systems, machines and networks.

In order to protect plants, systems, machines and networks against cyber threats, it is necessary to implement – and continuously maintain – a holistic, state-of-the-art industrial security concept.

Siemens' products and solutions constitute one element of such a concept.

Customers are responsible for preventing unauthorized access to their plants, systems, machines and networks. Such systems, machines and components should only be connected to an enterprise network or the internet if and to the extent such a connection is necessary and only when appropriate security measures (e.g. firewalls and/or network segmentation) are in place.

For additional information on industrial security measures that may be implemented, please visit <https://www.siemens.com/industrialsecurity>

Siemens' products and solutions undergo continuous development to make them more secure. Siemens strongly recommends that product updates are applied as soon as they are available and that the latest product versions are used. Use of product versions that are no longer supported, and failure to apply the latest updates may increase customer's exposure to cyber threats.

To stay informed about product updates, subscribe to the Siemens Industrial Security RSS Feed under <https://www.siemens.com/cert>

Subject to changes and errors. The information given in this document only contains general descriptions and/or performance features which may not always specifically reflect those described, or which may undergo modification in the course of further development of the products. The requested performance features are binding only when they are expressly agreed upon in the concluded contract.

All product designations may be trademarks or product names of Siemens AG or other companies whose use by third parties for their own purposes could violate the rights of the owners.